



# Panasonic®

## Operating Instructions

### Network Camera

Model No. WV-X6500 Series  
WV-S6500 Series  
WV-S6100 Series

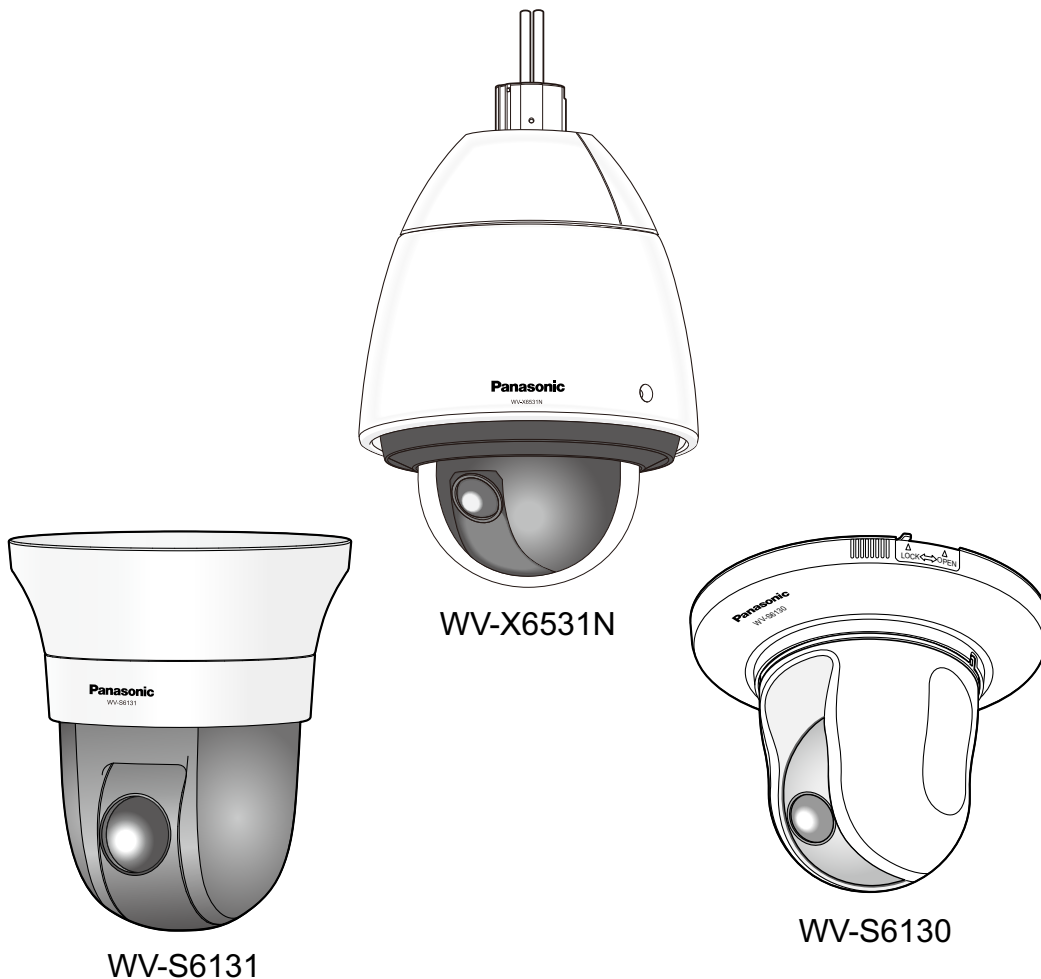

This manual covers the models: WV-X6500 Series (WV-X6531N, WV-X6531NPJ, WV-X6531NRF, WV-X6531NEG, WV-X6531NS, WV-X6511N), WV-S6500 Series (WV-S6530N), WV-S6100 Series (WV-S6131, WV-S6111, WV-S6130).

Before attempting to connect or operate this product, please read these instructions carefully and save this manual for future use.

The model number is abbreviated in some descriptions in this manual.



# Preface

## About the user manuals

There are 3 sets of operating instructions as follows.

- Operating Instructions (this document): Explains how to perform the settings and how to operate this camera.
- Important Information: Provides information about the cautions required for safely using and installing this camera.
- Installation Guide: Explains how to install and connect devices.

The screens used in these operating instructions show the case of WV-X6531N. Depending on the model used, the screens shown in the explanations may differ to the actual camera screens.

## About notations

The following notations are used when describing the functions limited for specified models.

The functions without the notations are supported by all models.

**X6531**: The functions with this notation are available when using the model WV-X6531N, WV-X6531NPJ, WV-X6531NRF, WV-X6531NEG, WV-X6531NS.

**X6511**: The functions with this notation are available when using the model WV-X6511N.

**S6131**: The functions with this notation are available when using the model WV-S6131.

**S6111**: The functions with this notation are available when using the model WV-S6111.

**S6130**: The functions with this notation are available when using the model WV-S6130.

**S6530**: The functions with this notation are available when using the model WV-S6530N.

## Abbreviations

The following abbreviations are used in these operating instructions.

Microsoft Windows 10 is described as Windows 10.

Microsoft Windows 8.1 is described as Windows 8.1.

Microsoft Windows 8 is described as Windows 8.

Microsoft Windows 7 is described as Windows 7.

Windows Internet Explorer 11, Windows Internet Explorer 10, Windows Internet Explorer 9 and Windows Internet Explorer 8 are described as Internet Explorer.

SDXC/SDHC/SD memory card is described as SD card or SD memory card.

Universal Plug and Play is described as UPnP™ or UPnP.

## For administrator registration

At the time of first access to the camera (or at the time of initialization), the registration screen will be displayed.

### Administrator registration

Enter the user name and password of the administrator.

User name (1 to 32 characters)	<input style="width: 90%; height: 20px;" type="text"/>
Password (8 to 32 characters)	<input style="width: 90%; height: 20px;" type="password"/>
Retype password	<input style="width: 90%; height: 20px;" type="password"/>

**Note:**

- (1) Distinguish between upper- and lower cases.
- (2) Entry of the following is not allowed as a user name: 2-byte characters, and 1-byte symbols " & ; ; \
- (3) Entry of the following is not allowed as a password: 2-byte characters, and 1-byte symbols " &
- (4) For the password, use two or more types of characters from alphabetic characters, numbers, and symbols.
- (5) Keep the user name and password at hand so as not to lose.
- (6) It is recommended to change the password periodically.

### [User name (1 to 32 characters)]

Enter the user name of the administrator.

**Available number of characters:** 1 - 32 characters

**Unavailable characters:** 2-byte characters, and 1-byte symbols " & ; ; \

### [Password (8 to 32 characters)]/[Retype password]

Enter the administrator password.

**Available number of characters:** 8 - 32 characters

**Unavailable characters:** 2-byte characters, and 1-byte symbols " &

#### Note

- Distinguish between upper- and lower cases.
- For the password, use two or more types of characters from alphabetic characters, numbers, and symbols.

### **IMPORTANT**

- If you forgot or do not know the password or user name, the camera must be initialized. Because all settings other than preset position settings are deleted when the camera is initialized, make sure to keep the information secure from third parties. Refer to "Parts and functions" section in the Important Information in the supplied CD-ROM for more information about initializing the camera.
- It is recommended to change the password periodically.

The registration completion screen will be displayed after registering a user name and password of the administrator. After 10 seconds, the camera will be reconnected automatically. Please click "here" if it is not displayed automatically.

When the camera is reconnected to, an authentication window is displayed. Enter the registered user name and password to start operation.

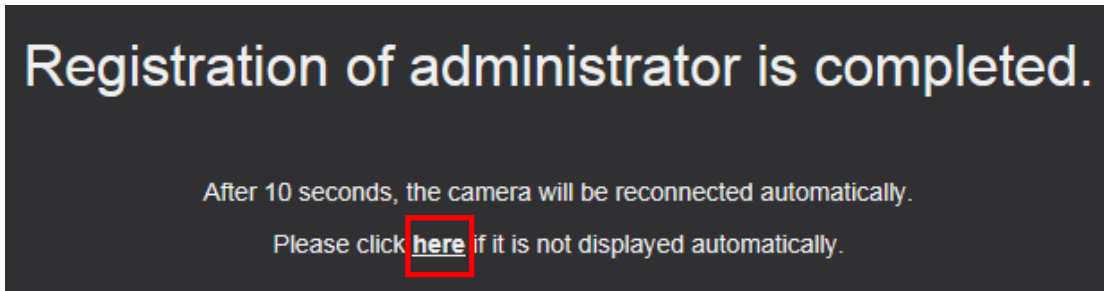

## Viewer software

In order to display H.265 (or H.264) images, send/receive audio to/from the camera, and play images saved on the SD memory card, the “Network Camera View 4S” (ActiveX) viewer software must be installed. This software can be installed directly from the camera or by selecting the [Install] button next to [Viewer Software] on the menu of the CD-ROM provided, and then following the on-screen instructions.

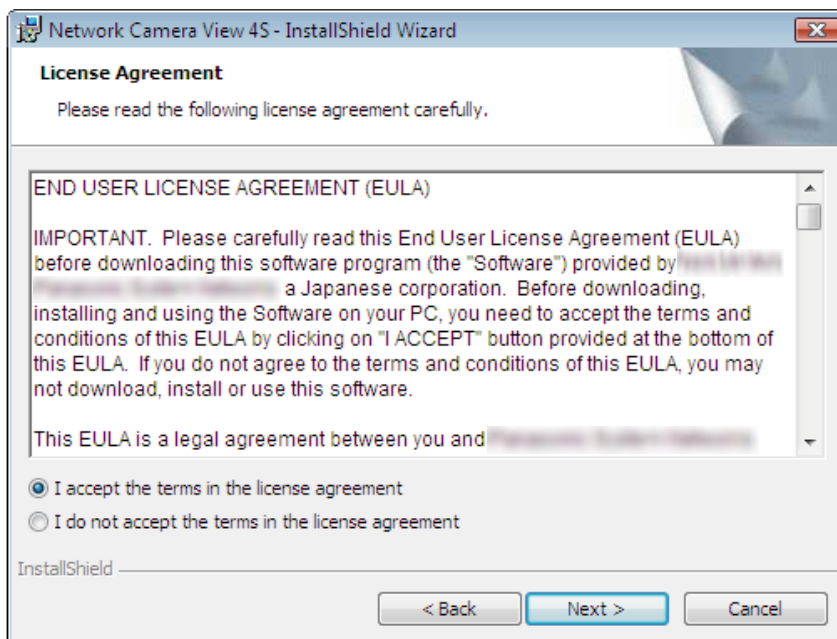

### IMPORTANT

- The default setting of “Automatic installation” is “On”. Follow the instructions on page 268 when the message is displayed on the information bar of the browser.
- Depending on the software environment of your PC, it may take time for the message to be displayed on the information bar of the browser.
- If you display the “Live” page on a PC and click the [Viewer Software] button, the installation screen for ActiveX, which is required for viewing camera images, is displayed. Follow the on-screen instructions and install the software. When displayed JPEG images (still images), there is no need to install ActiveX.

- When the install wizard is displayed again even after completing the installation of the ActiveX, restart the PC.
- The viewer software used on each PC should be licensed individually. The number of installations of the viewer software from the camera can be checked on the [Upgrade] tab of the “Maintenance” page (→page 239). Refer to your dealer for the software licensing.

# Table of Contents

<b>1</b>	<b>Operations</b>	<b>9</b>
1.1	<b>Monitor images on a PC</b>	<b>9</b>
1.1.1	Monitor images from a single camera	9
1.1.2	About the “Live” page	12
1.1.3	Monitor images from multiple cameras	18
1.2	<b>Monitor images on a cellular phone/mobile terminal</b>	<b>21</b>
1.2.1	Monitor images on a cellular phone	21
1.2.2	Monitor images on a mobile terminal (including smartphones)	23
1.3	<b>Record images on the SD memory card manually</b>	<b>30</b>
1.4	<b>Action at an alarm occurrence</b>	<b>32</b>
1.4.1	Alarm type	32
1.4.2	Action at an alarm occurrence	32
1.5	<b>Transmit images onto an FTP server</b>	<b>34</b>
1.5.1	Transmit an alarm image at an alarm occurrence (Alarm image transmission)	34
1.5.2	Transmit images at a designated interval or period (FTP periodic image transmission)	34
1.5.3	Save images on the SD memory card when images fail to transmit using the FTP periodic image transmission function	35
1.6	<b>Display the log list</b>	<b>36</b>
1.7	<b>Playback of images on the SD memory card</b>	<b>40</b>
1.7.1	Playback “JPEG(1)”/“JPEG(2)”/“JPEG(3)” images saved to the SD memory card	40
1.7.2	Playback “Stream(1)”/“Stream(2)”/“Stream(3)”/“Stream(4)” images saved to the SD memory card	43
<b>2</b>	<b>Settings</b>	<b>46</b>
2.1	<b>About the network security</b>	<b>46</b>
2.1.1	Equipped security functions	46
2.2	<b>Display the setup menu from a PC</b>	<b>47</b>
2.2.1	How to display the setup menu	47
2.2.2	How to operate the setup menu	48
2.2.3	About the setup menu window	49
2.3	<b>Use Easy Setup [Easy Setup]</b>	<b>51</b>
2.3.1	Configure the Internet settings [Internet]	51
2.3.2	Configure an event action [Event action]	52
2.3.2.1	Configure the schedule/alarm (event function type setup menu)	55
2.3.2.2	Alarm: Configure the terminal and VMD (alarm setup menu)	56
2.3.2.3	Alarm: Configure the alarm function type (Alarm function type setup menu)	59
2.3.2.4	Alarm: Configure the details for image transfer or recording conditions	60
2.3.2.5	Alarm: Configure the output terminal	62
2.3.2.6	Alarm: configure the mail notifications and mail server	63
2.3.2.7	Schedule: Configure SD recording or FTP periodic image transmission (schedule function type setup menu)	65
2.3.2.8	Schedule: Set SD memory recording (video recording setup menu)	65
2.3.2.9	Schedule: Configure FTP periodic image transmission (FTP periodic image transmission setup menu)	67
2.4	<b>Configure the basic settings of the camera [Basic]</b>	<b>71</b>
2.4.1	Configure the basic settings [Basic]	71
2.4.2	Configure the settings relating to the SD memory card [SD memory card]	78
2.4.3	Configure the settings relating to alteration detection [Alteration detection]	85
2.4.4	How to configure alteration detection settings	86
2.4.4.1	Generation of the CRT key (encryption key)	87

2.4.4.2	Generation of CSR (Certificate Signing Request) .....	88
2.4.4.3	Installation of the certificate issued by CA .....	89
2.4.4.4	Configuration of alteration detection .....	90
2.4.5	Access copy images saved on the SD memory card onto the PC [SD memory card images] .....	91
2.4.6	Configure the directory of the PC that images will be downloaded to [Log] .....	93
<b>2.5</b>	<b>Configure the settings relating to images and audio [Image/Audio] .....</b>	<b>95</b>
2.5.1	Configure the settings relating to the image capture mode [Image] .....	95
2.5.2	Configure the settings relating to JPEG images [Image] .....	96
2.5.3	Configure the settings relating to Stream [Image] .....	98
2.5.4	Configure the settings relating to the camera operations [Cam. Function] .....	105
2.5.5	Configure the settings relating to images and the preset positions [Image/ Position] .....	110
2.5.5.1	Configure the settings relating to image quality ("Image adjust" setup menu) .....	111
2.5.5.2	Set mask areas .....	121
2.5.5.3	Configure the settings relating to the preset positions ("Preset position" setup menu) .....	123
2.5.5.4	Configure the settings relating to the auto pan function ("Auto pan" setup menu) .....	127
2.5.5.5	Configure the settings relating to patrol ("Patrol" setup menu) .....	129
2.5.5.6	Configure the settings relating to auto track ("Auto track" setup menu) .....	131
2.5.5.7	Configure the settings relating to direction/angle setting ("Direction/Angle setting" setup menu) <b>X6531</b> <b>X6511</b> <b>S6131</b> <b>S6111</b> .....	137
2.5.5.8	Configure the settings relating to the privacy zone ("Privacy zone" setup menu) .....	138
2.5.5.9	Configure the VIQS setting .....	141
2.5.5.10	Configure the VIQS area .....	144
2.5.6	Configure the settings relating to audio [Audio] .....	146
<b>2.6</b>	<b>Configure the multi-screen settings [Multi-screen] .....</b>	<b>150</b>
<b>2.7</b>	<b>Configure the alarm settings [Alarm] .....</b>	<b>152</b>
2.7.1	Configure the settings relating to the alarm action [Alarm] .....	152
2.7.2	Configure the settings relating to the output terminal [Alarm] .....	154
2.7.3	Change the AUX name [Alarm] .....	155
2.7.4	Configure the settings relating to the camera action on alarm occurrence [Alarm] .....	156
2.7.4.1	Configure the settings relating to Preset per sender ("Preset per sender" setup menu) .....	159
2.7.4.2	Configure settings relating to image quality on alarm action .....	159
2.7.4.3	Configure settings relating to alarm E-mail notifications .....	161
2.7.4.4	Configure settings relating to FTP transmissions of alarm images .....	162
2.7.4.5	Configure settings relating to recording to an SD memory card when an alarm occurs .....	163
2.7.4.6	Configure settings relating to Panasonic alarm protocol notification when an alarm occurs .....	164
2.7.4.7	Configure settings relating to HTTP alarm notification when an alarm occurs .....	165
2.7.5	Configure the VMD settings [VMD area] .....	165
2.7.6	Set the VMD areas [VMD area] .....	168
2.7.7	Configure the settings relating to the audio detection [Audio detection] .....	170
2.7.8	Configuration of the settings relating to alarm notification [Notification] .....	172
2.7.8.1	Configure the settings relating to Panasonic alarm protocol .....	173
2.7.8.2	Configure the settings relating to HTTP alarm notification .....	175
<b>2.8</b>	<b>Configure the settings relating to the authentication [User mng.] .....</b>	<b>177</b>
2.8.1	Configure the settings relating to the user authentication [User auth.] .....	177
2.8.2	Configure the settings relating to the host authentication [Host auth.] .....	180

2.8.3	Configure IEEE 802.1X [IEEE 802.1X]	182
2.8.4	Configure the data encryption settings [Data encryption]	182
<b>2.9</b>	<b>Configuring the network settings [Network]</b>	<b>185</b>
2.9.1	Configure the network settings [Network]	185
2.9.2	Configure advanced network settings [Advanced]	190
2.9.2.1	Configure the settings related to sending E-mails	191
2.9.2.2	Configure the settings related to FTP transmission	196
2.9.2.3	Configure the settings relating to the NTP server	200
2.9.2.4	Configure the UPnP settings	201
2.9.2.5	Configure the HTTPS settings	203
2.9.2.6	Configure the settings relating to DDNS	204
2.9.2.7	Configure the settings relating to SNMP	206
2.9.2.8	Configure the QoS settings	207
2.9.3	How to configure HTTPS settings	209
2.9.3.1	Select the certificate to use when accessing with HTTPS	210
2.9.3.2	Obtaining the root certificate	210
2.9.3.3	Configuration of HTTPS connections	216
2.9.3.4	Generation of the CRT key (SSL encryption key)	217
2.9.3.5	Generation of CSR (Certificate Signing Request)	218
2.9.3.6	Installation of the CA certificate	219
2.9.4	Access the camera using the HTTPS protocol (for pre-installed certificate)	220
2.9.4.1	Configuration of the host file	220
2.9.5	Access the camera using the HTTPS protocol (for CA Certification)	225
2.9.6	How to configure the settings relating to DDNS	226
2.9.6.1	Configuration of the DDNS service (Example of the “Viewnetcam.com” service)	227
2.9.6.2	When using “Dynamic DNS Update”	230
2.9.6.3	When using “Dynamic DNS Update(DHCP)”	231
<b>2.10</b>	<b>Configure the settings relating to the schedules [Schedule]</b>	<b>232</b>
2.10.1	How to set the schedules	235
2.10.2	How to delete the set schedule	237
<b>2.11</b>	<b>Maintenance of the camera [Maintenance]</b>	<b>239</b>
2.11.1	Check the system log [System log]	239
2.11.2	Upgrade the firmware [Upgrade]	239
2.11.3	Check the status [Status]	241
2.11.4	Reset the settings/Reboot the camera [Default reset]	244
2.11.5	Settings data/backing up or restoring logs [Data]	245
<b>3</b>	<b>Others</b>	<b>248</b>
<b>3.1</b>	<b>Using the CD-ROM</b>	<b>248</b>
3.1.1	About the CD launcher	248
3.1.2	Installing Panasonic “IP Setting Software”	249
3.1.3	Installing the manuals	250
3.1.4	Installing the Viewer software	250
3.1.5	Configure the network settings of the camera using the Panasonic “IP Setting Software”	251
<b>3.2</b>	<b>About the displayed system log</b>	<b>254</b>
<b>3.3</b>	<b>Troubleshooting</b>	<b>259</b>
<b>3.4</b>	<b>Directory structure of drive B</b>	<b>271</b>



# 1 Operations

## 1.1 Monitor images on a PC

The following are descriptions of how to monitor images from the camera on a PC.

### 1.1.1 Monitor images from a single camera

1. Start up the web browser.
2. Enter the IP address designated using the Panasonic “IP Setting Software” in the address box of the browser.
  - **Example when entering an IPv4 address:** http://URL registered using IPv4 address  
http://192.168.0.10/
  - **Example when entering an IPv6 address:** http://[URL registered using IPv6 address]  
http://[2001:db8::10]/

#### <Example of IPv4 access>



#### <Example of IPv6 access>



### **IMPORTANT**

- When the HTTP port number is changed from “80”, enter “http://IP address of the camera + : (colon) + port number” in the address box of the browser. (Example: http://192.168.0.11:8080)
- When the PC is in a local network, configure the proxy server setting of the web browser (under [Internet Options...] under [Tools] of the menu bar) to bypass the proxy server for the local address.

### **Note**

- Refer to page 220 and page 225 for further information about the case in which “HTTPS” is selected for “HTTPS” - “Connection” on the [Advanced] tab of the “Network” page (→page 185).

## 1 Operations

### 3. Press the [Enter] key on the keyboard.

→ The “Live” page will be displayed. Refer to page 12 for further information about the “Live” page.

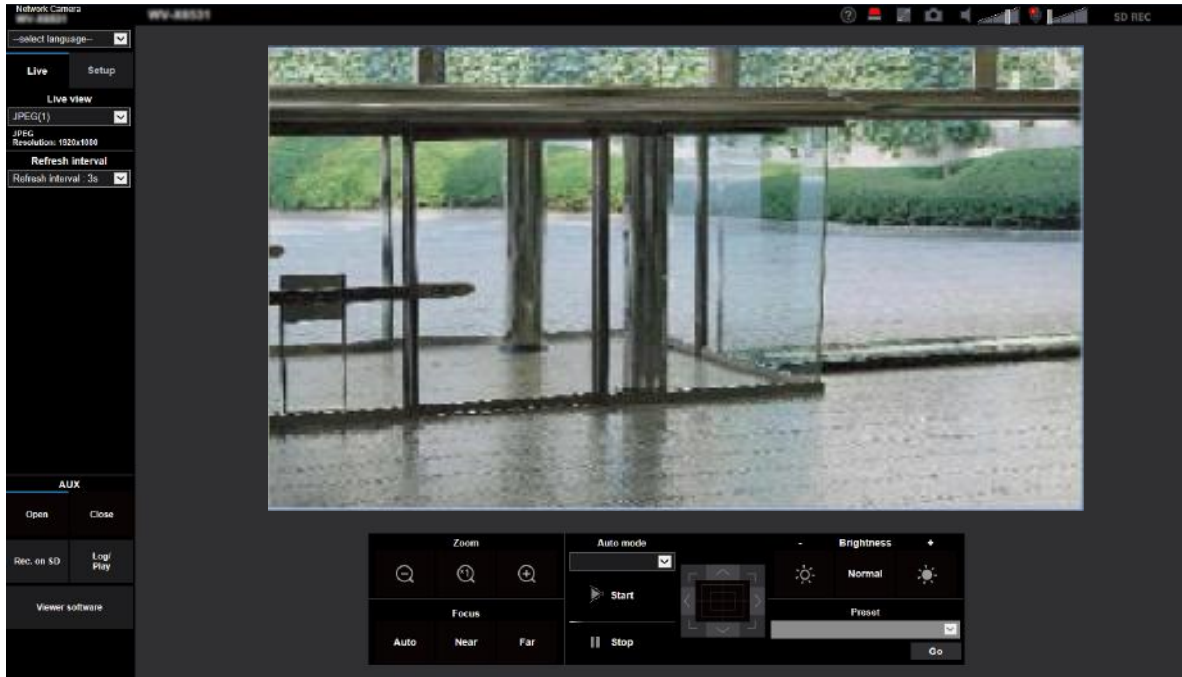

When “On” is selected for “User auth.”, the authentication window will be displayed before displaying live images for the user name and password entries.

### **IMPORTANT**

- It is recommended to change the password periodically.
- When displaying multiple H.265 (or H.264) images on a PC, images may not be displayed depending on the performance of the PC.

### **Note**

- The maximum number of concurrent access user is 14 including users who is receiving H.265 (or H.264) images and users who are receiving JPEG images. Depending on the set values for “Bandwidth control(bit rate)” and “Max bit rate (per client)\*”, the maximum concurrent access number may be 14 or less users. When 14 users are concurrently accessing, the access limit message will be displayed for users who subsequently attempt to access. When “Multicast” is selected for “Transmission type” of “Stream”, only the first user who accessed to monitor H.265 (or H.264) images will be included in the maximum number. The second and subsequent users who are monitoring H.265 (or H.264) images will not be included in the maximum number.
- If you set the “Stream transmission” (→page 98) to “On”, an H.265 (or H.264) image will be displayed based on the settings of the “Stream encoding format”. If you set the “Stream transmission” (→page 98) to “Off”, a JPEG image will be displayed. A JPEG image can be displayed even if the “Stream transmission” is set to “On”, but in that case, the transmission interval of the JPEG image will be limited to maximum 5 fps.
- The refresh interval may become longer depending on a network environment, PC performance, photographic subject, access traffic, etc.  
**<Refresh interval of JPEG images>**  
**When “On” is selected for “Stream transmission”**  
max. 5fps  
**When “Off” is selected for “Stream transmission”**

max. 30fps

## 1.1.2 About the “Live” page

**Note**

- The buttons and setting items displayed on the “Live” page can be changed depending on the user rights of the accessing user. You can set the user right settings from “User auth.” under “User mng.”. (→page 177)



- 1 [select language] pull-down-menu**  
The camera’s display language can be selected. The default language can be set in the [Menu language] in the [Basic] settings. (→page 71)
- 2 [Login] button**  
This button is displayed when “User auth.” is “On” and a person other than the administrator logs in, or when “User auth.” is “Off” and “Guest User” is set to “Use”. (→page 177)  
Even in the above case, the [Login] button will not be displayed if “Host auth.” is set to “On”, and the camera browser is opened from a host with administrator rights.



If login fails, close all the browsers, open the “Live” page and login once again.

- 3 [Setup] button**  
Displays the setup menu.
- 4 [Live view] pull-down menu**  
You can select and switch to the image to be displayed in the main area from the following:  
Stream(1)/Stream(2)/Stream(3)/Stream(4)/JPEG(1)/JPEG(2)/JPEG(3)/Multi-screen  
The image in the main area is displayed based on the contents set in Stream(1) – (4) (→page 98), JPEG(1) – (3) (→page 96), or Multi-screen (→page 150).

Also the first stream displayed when you accessed the camera can be set from “Initial display stream” of the [Image] tab. For “Multi-screen”, you can set the “Initial display” in the [Multi-screen] tab.

**Note**

- When “2048×1536”, “1920×1080”, “1280×960” or “1280×720” is selected for the image capture size, it may become smaller than the actual size depending on the window size of the web browser.

⑤ **Stream information display**

Displays the setup for stream encoding format, image capture size, bit rate, and frame rate for the live view of a stream.

**Note**

- Displays the values set in the stream. The actual bit rate and frame rate vary depending on the network environment and the used PC.

⑥ **[Refresh interval] pull-down menu**

This pull-down menu will be displayed only when a JPEG image is displayed. Use it to select the display method of the JPEG image.

- **MJPEG:** Uses viewer software to display JPEG images successively as MJPEG (Motion JPEG). Not available if the viewer software is not installed.
- **Refresh interval : 1s/Refresh interval : 3s/Refresh interval : 5s/Refresh interval : 10s/Refresh interval : 30s/Refresh interval : 60s:** Refreshes JPEG format (still images) images at the specified interval.

**Note**

- Depending on the network environment or the PC used, JPEG format (still images) images may not be refreshed at the specified interval.

⑦ **[AUX] button<sup>2</sup>**

These buttons will be displayed only when “Terminal 3” of “Alarm” is set to “AUX output” on the setup menu. (→page 56)

- **[Open] button:** The status of the AUX connector will be open.
- **[Close] button:** The status of the AUX connector will be closed.

**Note**

- The names of “AUX”, “Open” and “Close” can be changed. (→page 155)

⑧ **[Rec. on SD] button<sup>2</sup>**

The [Rec. on SD] button will be displayed only when “Manual” is selected for “Save trigger” on the [SD memory card] tab. (→page 81)

Click this button to manually record images on the SD memory card. Refer to page 30 for descriptions of how to manually record images on the SD memory card.

⑨ **[Log] button<sup>2</sup>**



When the [Log] button is clicked, the log list will be displayed and images saved on the SD memory card can be played.

Refer to page 36 for further information about the log list and for how to play images on the SD memory card.

⑩ **[Viewer Software] button**

Starts installation of the viewer software for display. This button will not be available if the viewer software is already installed on the PC, or if the “Automatic installation” of the [Viewer software (nwcvc4Ssetup.exe)] in the [Basic] tab is set to “Off”. (→page 76)

⑪ **[Zoom] button<sup>2</sup>**

-  : Click this button to adjust the zoom ratio to the “Wide” side.
-  : Click this button to set the zoom ratio to x1.0.
-  : Click this button to adjust the zoom ratio to the “Tele” side.

### ⑫ [Focus] button<sup>2</sup>

- **Auto** : Click this button to adjust the focus automatically.
- **Near** : Click this button to adjust the focus to the “Near” side.
- **Far** : Click this button to adjust the focus to the “Far” side.

#### **Note**

- When shooting the following place or the following subjects, focus may not be adjusted automatically. Adjust the focus manually.
  - Shiny or strongly reflective subject
  - Subject through the glass with dew or smudge
  - Two subjects whose distances from the camera are different
  - Less contrast subject (e.g. white wall)
  - Horizontal-striped subject such as a window blind
  - Inclined subject
  - Dark subjects

### ⑬ Auto mode<sup>2</sup>



Select an operation from the pull-down menu and click the [Start] button. The selected operation will start. Click the [Stop] button to stop the operation. The selected operation will stop when the camera (panning/tilting/ zooming/ focusing) is operated or when an action to be taken according to the settings for “Self return” (→Page 105) or for “Camera action on alarm” (→Page 156) starts.

#### **Note**

- Operating in the auto mode for a long period of time wears the driving parts, and the replacement interval of those parts may be shortened. Refer to the Important Information in the supplied CD-ROM for the consumable parts.
- **Auto track:** Automatically tracks objects in the shooting area.

#### **Note**

- The auto-track function is not available under the following conditions:
  - When “Image capture mode” is set to “2 mega pixel [16:9](60fps mode)” or “1.3 mega pixel [16:9](60fps mode)”
  - When “On” is selected for “Stabilizer”
  - When other than “Off” is selected for “Smart Facial Coding” of “Smart Coding” for “Stream(1)”
  - When “Maximum shutter” of “Image adjust” - “Light control mode” is the following:  
Max.2/30s/ Max.4/30s/ Max.6/30s/ Max.10/30s/ Max.16/30s
- With the Auto track feature, objects moving in the screen are picked out and automatically tracked.
- In the following situations, targets may not be able to be tracked, or false detections may occur.
  - when there is little contrast between the subject and the background
  - when dirt, drip, or splash is on the dome cover of camera
  - when there are large changes to the lighting intensity
  - when there are many moving objects other than the subject
  - when there is a change on the optical axis (in a vertical direction) of the camera
  - when the subject moves directly underneath the camera
  - when there is harsh flickering
  - when there are reflections from light entering the front glass due to reflections from a window or road, or from a backlight
  - when the target is hidden behind a utility pole or other objects
  - when the subject passes by other moving objects
  - when the target moves too fast or too slow
  - when the camera is shaking

- When the zoom ratio is set to the “Tele” side, it may be difficult to obtain accuracy with the auto tracking function. It is recommended to use the auto tracking function with setting the zoom ratio to the “Wide” side.
  - During auto tracking, if the camera is operated using the control pad or by other methods, or if an alarm occurs, auto tracking is stopped.
  - **Auto pan:** Automatically pans between the start position and the end position set in advance (→Page 127).  
Even when the camera is operated for zooming or focusing, the camera continues panning. (However, panning will stop when the zoom button (x1) is clicked.)
  - **Preset sequence:** Automatically moves to the preset positions (→Page 123) orderly (start from the lowest preset position number).
  - **Patrol 1-4:** Performs patrols 1-4 that were set in advance. (→Page 129)
- ⑭ **Control pad/buttons**<sup>2</sup>  
Left-click on the control pad or buttons to adjust the horizontal/vertical position of the camera (panning/tilting). Panning/tilting speed will be faster if a clicked point gets farther from the center point of the control pad.  
It is also possible to pan/tilt the camera by dragging the mouse.  
Zoom and focus can be adjusted by right-clicking. When an upper/lower area of the control pad is right-clicked, the displayed image will be zoomed in/out on. When a left/right area is right-clicked, the focus will be adjusted to the Near/Far side.  
Zoom can also be adjusted using the mouse wheel.
- ⑮ **[Brightness] buttons**<sup>2</sup>  
The brightness is adjustable from 0 to 255. Click the  button to make the image brighter, or click the  button to make the image darker. If you click the [Normal] button, the display will be reset to default.
- ⑯ **[Preset]**<sup>2</sup>  
Select a preset position from the pull-down menu and click the [Go] button. The camera will move to the selected preset position (→Page 123). “H” next to the preset position number indicates the home position. When “Home position” is selected, the camera will move to the home position. (→Page 105)  
When “Preset ID” is registered for a preset position, the registered preset ID will be displayed next to the preset position number.
- ⑰ **Camera title**  
The camera title entered for “Camera title” on the [Basic] tab will be displayed. (→page 72)
- ⑱ **Support button**  
When this button is clicked, the support site below will be displayed in a newly opened window. This website contains technical information, FAQ, and other information.  
<https://security.panasonic.com/support/>
- ⑲ **Alarm occurrence indication button**<sup>2</sup>  
When an alarm occurs, the display flashes. When this button is clicked, the output terminal will be reset and this button will disappear. (→page 32)

**Note**

- Since the blinking of the alarm occurrence indication button is not coupled to recording images to the SD memory card, forwarding E-mails, or other operations, check the settings of each operation separately.
- ⑳ **Full screen button**  
Images will be displayed on a full screen. If the full screen button is clicked once when the image displayed in the main area is smaller than the main area, the image is displayed corresponding to its image capture size. If the full screen button is clicked once when images are displayed corresponding to their image capture sizes, images are displayed in full screen. To return to the “Live” page when displaying an image in full screen, press the [Esc] key.

### ⑳ Snap shot button

Click this button to take a picture (a still picture). The picture will be displayed on a newly opened window. When right-clicking on the displayed image, the pop-up menu will be displayed. It is possible to save the image on the PC by selecting "Save" from the displayed pop-up menu.

When "Print" is selected, printer output is enabled.

#### **Note**

- The following settings may be required.  
Open Internet Explorer, click [Tools] → [Internet Options] → [Security] → [Trusted Sites] → [Sites]. Register the camera address on [Website] of the displayed trusted windows. After registration, close the web browser, and then access the camera again.
- When it takes longer than the specified period to obtain the snap shot picture due to the network environment, the snap shot picture may not be displayed.
- If the image capture size specified for JPEG cannot be obtained, JPEG images are displayed with the image capture size that could be obtained.  
Therefore, when JPEG images obtained with snap shot are displayed on a PC, the displayed image size may differ from the captured sized.

### ㉑ Mic input button

Turns on/off the audio reception (hear audio from the camera on a PC). This button will be displayed only when "Mic input", "Interactive(Full-duplex)", or "Interactive(Half-duplex)" is selected for "Audio transmission mode" on the setup menu. (→page 146)

When the audio reception is turned off, the button will turn into the  button and audio from the camera will not be heard.

Audio volume can be adjusted (Low/ Middle/ High) by moving the volume cursor .

#### **Note**

- When "Audio volume control mode" is set to "Adjust Mic input" in the setup menu, the volume cursor is not displayed when using "Audio recording" or "Audio detection".
- When the camera is restarted, the adjusted volume level (for the reception) will return to the level that had been set on the [Audio] tab on the setup menu. (→page 146)
- Actual volume level will change in three steps even though the volume cursor can be adjusted minutely.
- If multiple camera browsers are open at the same time on the same computer, audio cannot be heard from the camera browsers that were opened later. Please only access 1 camera at a time.

### ㉒ Audio output button

Turns on/off the audio transmission (play audio from the PC on the unit speaker). This button will be displayed only when "Audio output", "Interactive(Full-duplex)" or "Interactive(Half-duplex)" is selected for "Audio transmission mode" on the setup menu. (→page 146)

The button will blink during the audio transmission. When the audio transmission is turned off, the button display will switch to the , and audio from the PC will not be heard.

Audio output volume can be adjusted (Low/Middle/High) by moving the volume cursor .

#### **Note**

- When a user is using the audio transmission function with "Interactive(Half-duplex)" selected, the receiver button and the transmission button will be inoperable for the other users. When "Interactive(Full-duplex)" is selected, the transmission button is inoperable for other users.
- The maximum duration of a single audio output is the audio output duration set in the [Audio] tab on the "Image/Audio" page. Audio output stops when the specified audio output duration has passed. To turn the audio transmission function on, click the [Audio output] button again.



- When the camera is restarted, the adjusted volume level (for both the audio transmission and reception) will return to the level that had been set on the [Audio] tab on the “Image/Audio” page. (→page 146)
- Actual volume level will change in three steps even though the volume cursor can be adjusted minutely.

#### ②④ SD recording status indicator

The status of the SD recording can be checked with this indicator.

When the SD recording starts, the SD recording status indicator will light red. It will go off when the SD recording stops.

This indicator will be displayed when “Manual” or “Schedule” is selected for “Save trigger” on the setup menu. (→page 78)

#### ②⑤ Main area

Images from the camera will be displayed in this area.

The current time and date will be displayed according to the settings configured for “Time display format” and “Date/time display format”. (→page 71)

In addition, when being adjusted, the status of brightness (→Page 74), camera position (→Page 107), and the preset ID (→Page 125) will be displayed as well as the characters configured for “Camera title on screen” (→Page 73).

Click a desired point in the main area on the “Live” page that is to be the center of the angle of view. The camera moves to adjust the position in order to set the clicked point as the center.<sup>3</sup>

When selecting an area in the main area by dragging the mouse, the selected area will be located at the center of the main area. In this case, the zoom ratio will be adjusted automatically.<sup>3</sup>

A zoom operation can be performed using the mouse wheel.

When the main area of the “Live” page is right-clicked, “Auto track” starts for the clicked object. Depending on the targeted object or its surroundings, “Auto track” may not perform normally.

#### **Note**

- When the camera is operated by a user with a low access level, images displayed on the screen may be changed temporarily. This does not affect operation of the camera.
- Depending on the PC in use, screen tearing\* may occur when the shooting scene drastically changes due to the GDI restrictions of the OS.  
\*A phenomenon in which portions of the screen are displayed out of alignment.
- When the displayed image is highly zoomed, the clicked point may not always be located at the center of the image.
- If dragging the mouse to the angle exceeding the rotation range of the camera, the camera will change its direction to the operable position and adjusts the zoom ratio automatically.

<sup>\*1</sup> Only operable by users whose access level is “1. Administrator”.

<sup>\*2</sup> Only operable by users whose access level is “1. Administrator” or “2. Camera control” when “On” is selected for “User auth.” (→page 177)

<sup>\*3</sup> As the tilt angle approaches 90°, because the difference between the specified position and the actual direction in which the camera is moving increases, the camera may not move to the specified angle of view.

### 1.1.3 Monitor images from multiple cameras

Images from multiple cameras can be displayed on a multi-screen. Images from 4, 9, and up to 16 cameras can be displayed simultaneously. To display images on a multi-screen, it is necessary to register cameras in advance. 4 cameras can be registered as a group and up to 4 groups (16 cameras) can be registered. (→page 150)

#### **IMPORTANT**

- When video is displayed in 4 screens and 9 screens, the video and audio may cut out because the transmission volume of other cameras is large. In such cases, the setting of the registered cameras needs to be changed to reduce the transmission volume.  
Example of setup to reduce the transmission volume:
  - Set the video transmission format to “H.265” or “H.264”.
  - Set the “Transmission priority” (→page 100) of the stream to “Best effort”.
- To enable the audio for multi-screen, the audio must be enabled for the camera.
- When 16 screens are used for the display, only still images (JPEG) can be refreshed.

#### **Note**

- Multi-screen can be used to display JPEG images, and H.265 (or H.264) images. If other cameras support audio, audio is also output.
- For further information about “Network Camera Recorder with Viewer Software Lite”, which is suited to viewing images from several cameras, refer to our website (<https://security.panasonic.com/support/info/>).
- When you have registered a camera with the authentication function enabled, enter the user name and password of the “Administrator” for the registered camera in the “Authentication dialog”. Refer to the Panasonic support website below for information about the terms and conditions for use of multi-screen.  
<https://security.panasonic.com/support/info/>

- From the “Live view” pull-down menu in the “Live” page, select “Multi-screen”.  
→ Images from the registered cameras will be displayed on a selected multi-screen (screen can be split up to 16 areas). The following are instructions when displaying on a 4-split screen.

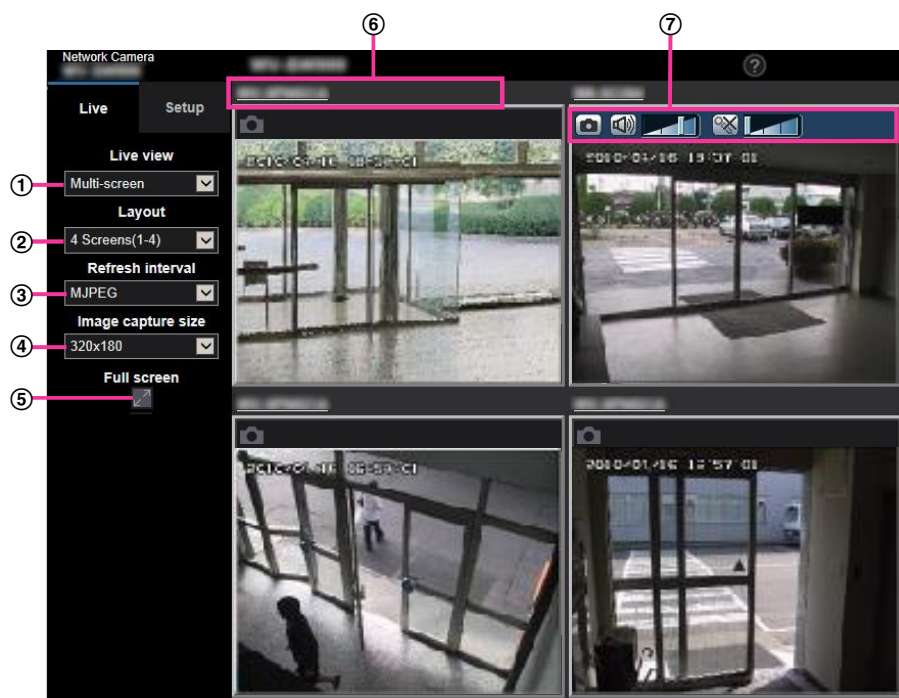

- “Live view” pull-down menu**  
Select the image displayed in the main area.
- [Layout] pull-down menu**  
Select from the pull-down menu to display images from cameras in multi-screens of 4 to 9 or even 16 screens.
- [Refresh interval] pull-down menu**  
Select from the pull-down menu and switch between video (H.265/H.264/MJPEG) and still images (JPEG).  
For still images (JPEG), select the refresh interval (Refresh interval : 1s/Refresh interval : 3s/Refresh interval : 5s/Refresh interval : 10s/Refresh interval : 30s/Refresh interval : 60s) for camera images.  
When the 16 screen layout is used, Refresh interval : 1s cannot be selected.
- [Image capture size] pull-down menu**  
Select the image capture size from the pull-down menu to change it.  
When you select “4 Screens” in the [Layout] pull-down menu, the image capture size of the camera changes.
  - When the aspect ratio is 4:3:**  
Switching between QVGA (default) and VGA
  - When the aspect ratio is 16:9:**  
Switching between 320×180 (default) and 640×360
- Full screen display**  
If you press the full screen button, the display of the camera image will be maximized. If you click the  (reset) button in the full screen display, the display size will be reset to original size.
- Camera title**  
If you click the camera title, live images from the corresponding camera will be displayed on the “Live” page of the newly opened window.
- Camera control bar**  
Can be used to get snap shot of JPEG images or to adjust the PC mic input/output volume (mic input or audio output).

### **Note**

- The frame rate may drop depending on the network environment and number of accessing users.
- If the image capture size specified for JPEG cannot be obtained, a JPEG image with an image capture size that could be obtained is displayed. Therefore, when JPEG images obtained with snapshot are displayed on a PC, the displayed image size may differ from the captured size.

## 1.2 Monitor images on a cellular phone/mobile terminal

### 1.2.1 Monitor images on a cellular phone

It is possible to connect to the camera using a cellular phone via the Internet and monitor images (JPEG only) from the camera on the screen of the cellular phone. It is also possible to refresh images to display the latest image.

#### **IMPORTANT**

- When the authentication window is displayed, enter the user name and password.  
To enhance the security, it is recommended to change the password periodically. (→page 177)
- If the cellular phone in use is not compatible with UTF-8 encode, it is impossible to display the screen correctly.
- When "VGA", "QVGA", "640x360", or "320x180" is not selected for either one of "JPEG(1)", "JPEG(2)", or "JPEG(3)" of [JPEG] on the [Image] tab, images cannot be viewed from cellular phones.
- Audio is not supported for cellular phones.

#### **Note**

- It is necessary to configure the network settings of the cellular phone in advance to connect to the Internet and monitor images from the camera. (→page 185)
  - When "Auto" is selected for "Menu language", the screen is displayed in English. If you want the screen to be displayed in Japanese or Chinese, select "Japanese" or "Chinese" for "Menu language". (→page 71)  
For further information about compatible devices, refer to our website (<https://security.panasonic.com/support/info/>).
1. Access to "http://IP address/mobile" or "http://Host name registered in the DDNS server/mobile" using a cellular phone.  
→ Images from the camera will be displayed.

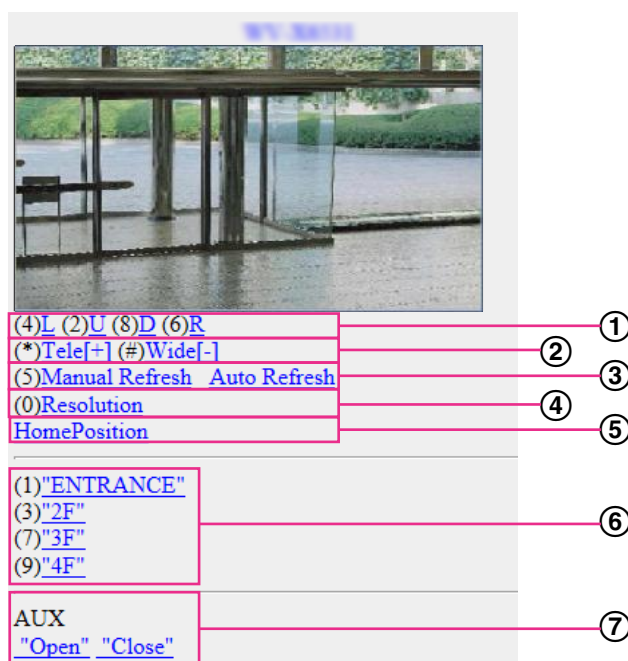

- ① Pan/Tilt  
Controls the camera direction. The camera will pan or tilt to each direction by pressing the corresponding dial key.
  - ② Zoom display  
It is possible to perform zooming operations of the camera by pressing “\*” or “#”.
  - ③ Refresh control  
Press the dial key “5” or the [Manual Refresh] button to refresh the camera images.  
Press the [Auto Refresh] button to refresh the images from the camera in 5-second intervals.  
When the dial key “5” or the [Manual Refresh] button is pressed again, the refresh mode of the camera will return to manual refresh.
- IMPORTANT**
- Transmission will be periodically performed when “Auto Refresh” is selected for the camera image. Confirm the contract plan of the cellular phone in use before using this function.
  - Depending on the cellular phone in use, “Auto Refresh” may be unavailable.
- ④ Resolution control  
Changes the image capture size by pressing the dial key “0”.
    - Image in the aspect ratio of “4:3”: Changes the image capture size between 320x240 (default) and 640x480.
    - Image in the aspect ratio of “16:9”: Changes the image capture size between 320x180 (default) and 640x360.
  - ⑤ Home position  
The camera will move to the home position. (→Page 105)  
Home position will be displayed only when home position is set.
  - ⑥ Preset  
The camera images will be displayed in a preset direction when a dial key on each window is pressed. (The dial key numbers are not displayed for Preset No. 5 or greater. Only preset IDs will be displayed.) (→Page 123)
  - ⑦ AUX control  
Controls the AUX terminal. These buttons will be displayed only when “AUX output” is selected for “Terminal 3” on the setup menu. (→page 56)

### Note

- Some cellular phones cannot change the image capture size even when resolution is changed by resolution control.
- Depending on the image capture size selected for “JPEG(1)”, “JPEG(2)”, or “JPEG(3)”, “Resolution” may not be able to be used.
- When the HTTP port number is changed from “80”, enter “http://IP address: (colon) + port number/mobile”<sup>1</sup> in the address box of the browser. When using the DDNS function, access to “http://Host name registered in the DDNS server: (colon) + port number/mobile”.
- When “HTTPS” is selected for “HTTPS” - “Connection” on the [Advanced] tab of the “Network” page, enter as follows.  
“https://IP address: (colon) + port number/mobile” or “https://Host name registered in the DDNS server: (colon) + port number/mobile”
- When the authentication window is displayed, enter the user name of an administrator or user and password. Depending on the cellular phone in use, password entry may be required each time the screen is switched.
- It is impossible to send and receive audio using a mobile terminal.
- Depending on the cellular phone in use, larger size images may not be displayed. In this case, selecting a setting close to the lowest quality setting for “Image quality setting” of “JPEG” (→page 96) may sometimes solve this problem.
- Depending on the cellular phone in use or its contract plan, it may be impossible to access.

- The operations menu displayed on the mobile telephone screen may not be displayed depending on the user rights and access level of the accessing user. To display the operations menu, it is necessary to set the user rights and access level (“User auth.” in “User mng.”). (→page 177)

<sup>\*1</sup> IP address is the global WAN IP address of the router that can be accessed via the Internet.

## 1.2.2 Monitor images on a mobile terminal (including smartphones)

It is possible to connect to the camera using a mobile terminal via the Internet and monitor images (MJPEG or JPEG) from the camera on the screen of the mobile terminal. It is also possible to refresh images to display the latest image.

The compatible mobile terminals are shown as follows. (As of July, 2017)

- iPad, iPhone (iOS 4.2.1 or later)
- Android™ mobile terminals

When an Android terminal is used, an MJPEG format image is displayed by the Firefox® browser, and a JPEG format image is displayed by the standard browser.

For further information about compatible devices, refer to our website (<https://security.panasonic.com/support/info/>).

### IMPORTANT

- When the authentication window is displayed, enter the user name and password. To enhance the security, it is recommended to change the password periodically. (→page 177)

### Note

- It is necessary to configure the network settings of the mobile terminal in advance to connect to the Internet and monitor images from the camera. (→page 185)
1. Access to “<http://IP address/cam>”<sup>\*1</sup> or “<http://Host name registered in the DDNS server/cam>”<sup>\*2</sup> using a mobile terminal.  
→ Images from the camera will be displayed.

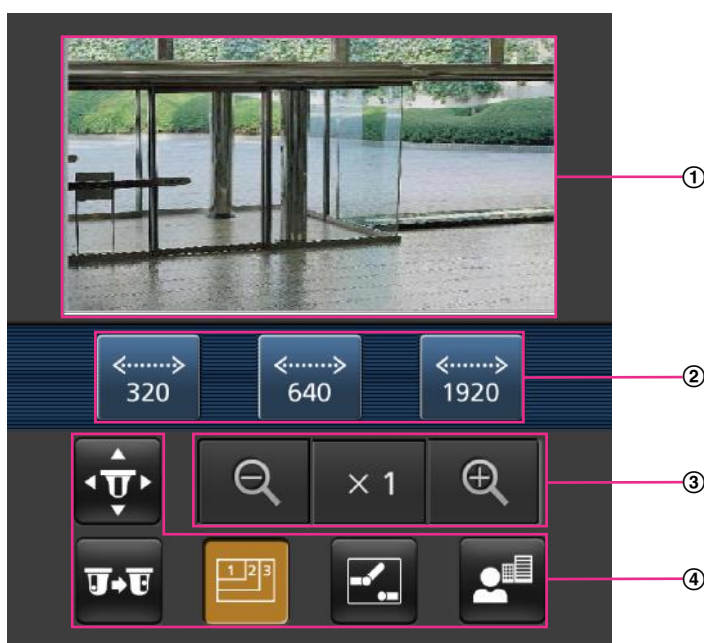

## 1 Operations

---

- ① Live images area  
Displays images from the camera.
- ② Operation buttons area  
When functions are selected in the function selection area ④, buttons to operate those functions are displayed.
- ③ Zoom operation area  
Buttons to operate the zoom are displayed.
- ④ Function selection area  
When functions that can be operated are selected, operation buttons are displayed in the operation buttons area ②.

### Note

- The operations button displayed on the mobile terminal screen may not be available depending on the user rights and access level of the accessing user. To display the operations button, it is necessary to set the user rights and access level ("User auth." in "User mng."). (→page 177)

2. Click the button of the function that you want to operate.

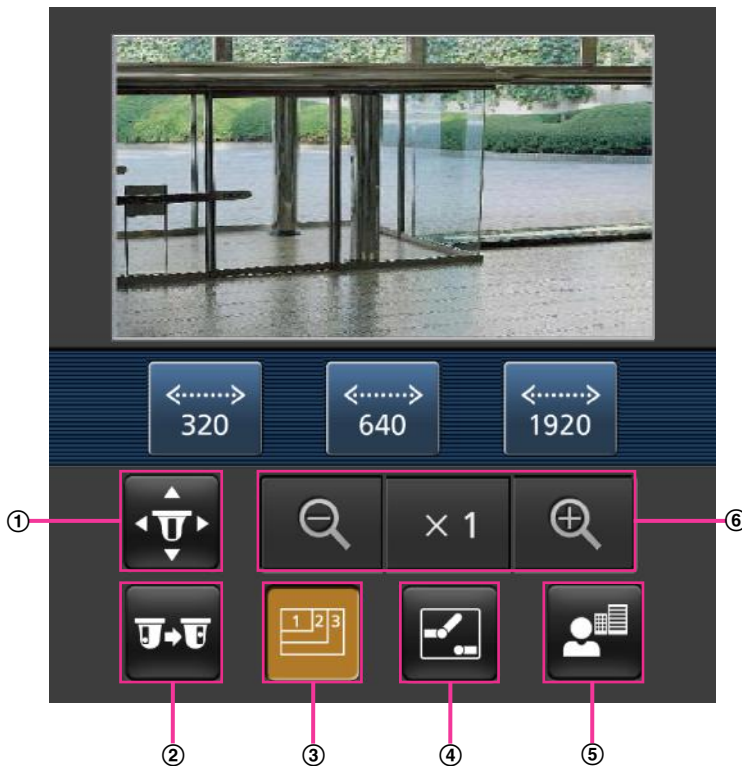





- ① Pan/Tilt
- ② Preset
- ③ Resolution control
- ④ AUX control
- ⑤ Focus display
- ⑥ Zoom display

Each function is explained below.



## ① Pan/Tilt

Press the  button to display the buttons used to operate pan/tilt on the screen. The pan/tilt can be adjusted in each direction with the , , , and  buttons.

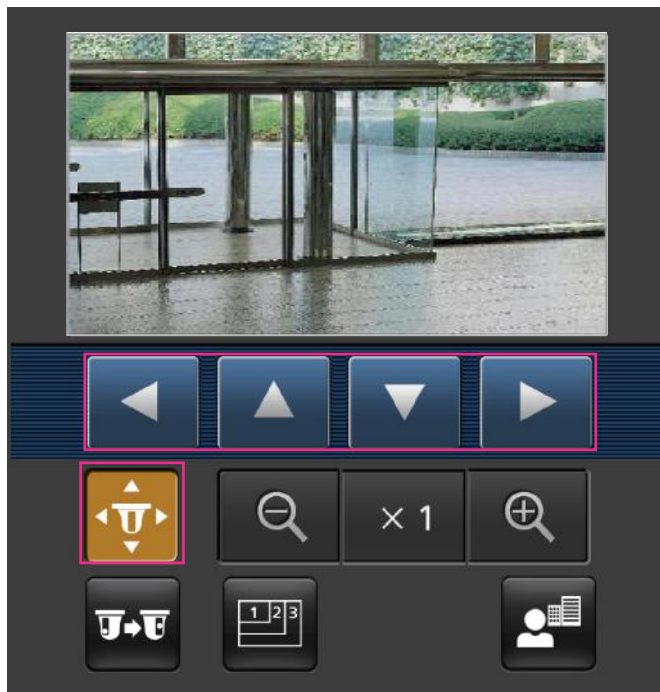

## ② Preset

Press the  button to display the buttons used to select the preset position on the screen. Camera images are displayed of the registered preset camera directions according to the preset numbers selected from the buttons.

- Only position numbers 1-4 for the preset positions are displayed.
- Only registered preset positions are displayed. Unregistered preset positions are not displayed.

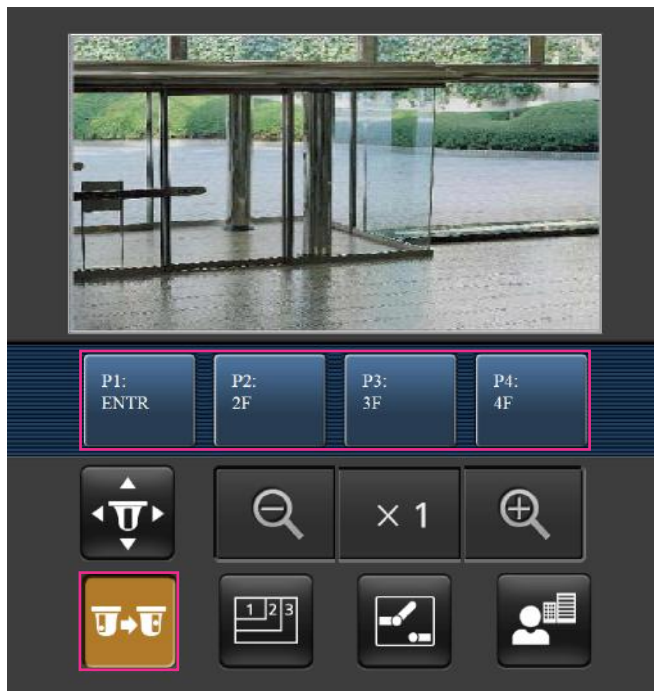

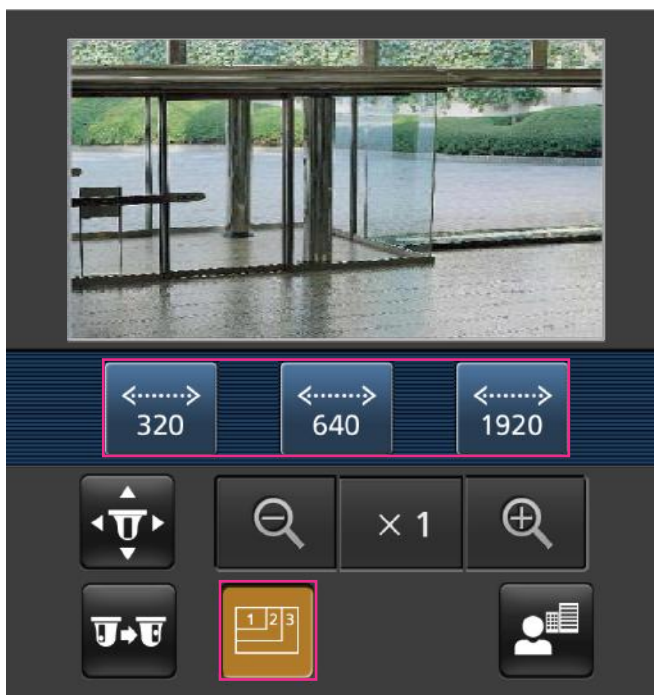

### ③ Resolution control

Press the  button to display the buttons used to select the resolution on the screen. The resolution can be changed by selecting a resolution setting from the buttons. Images are displayed in the image capture size selected in “JPEG(1)”, “JPEG(2)”, or “JPEG(3)” of [JPEG] on the [Image] tab.



## ④ AUX control

Press the  button to display the buttons used to operate the AUX output on the screen. The AUX output terminals can be controlled with the  and  buttons.



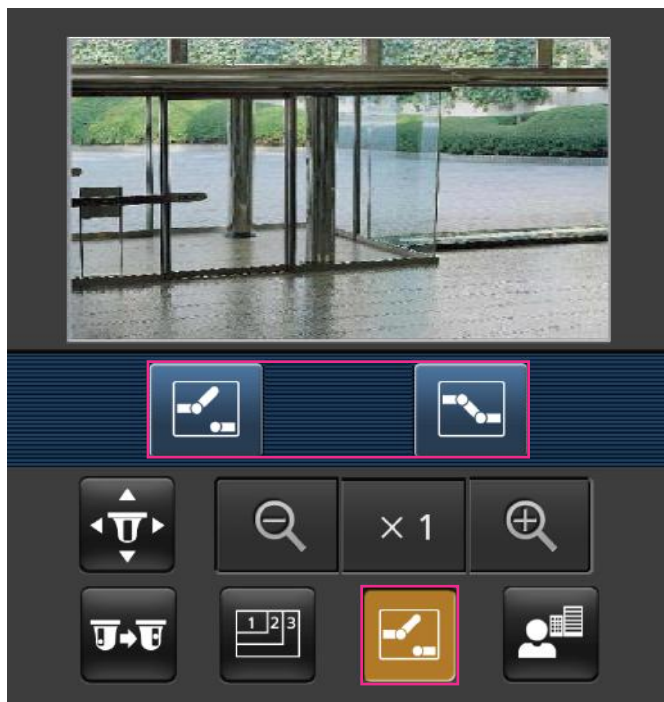

This function is only displayed when [Terminal 3] is set to [AUX output] on the settings menu.

(→Page 57)





## 1 Operations

### ⑤ Focus display

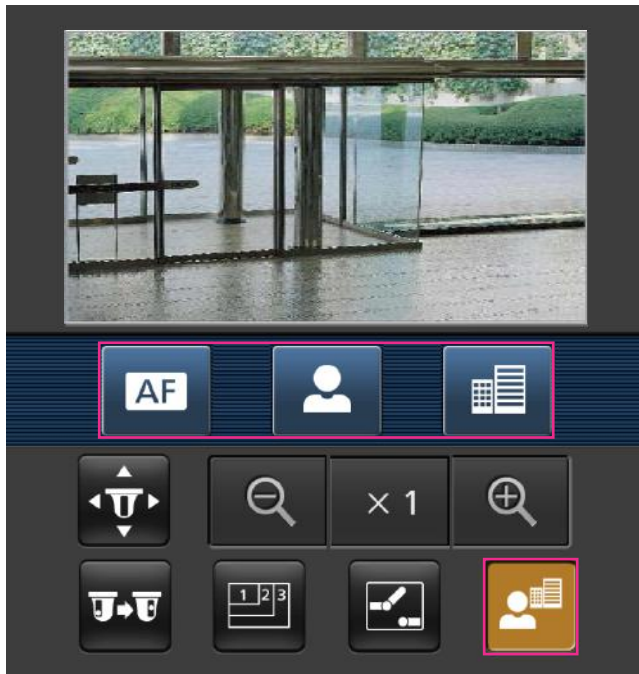
Press the  button to display the buttons used to operate the focus on the screen. The camera's focus can be operated with the , , and  buttons.



### ⑥ Zoom display

The camera's zoom can be operated with the , , and  buttons.

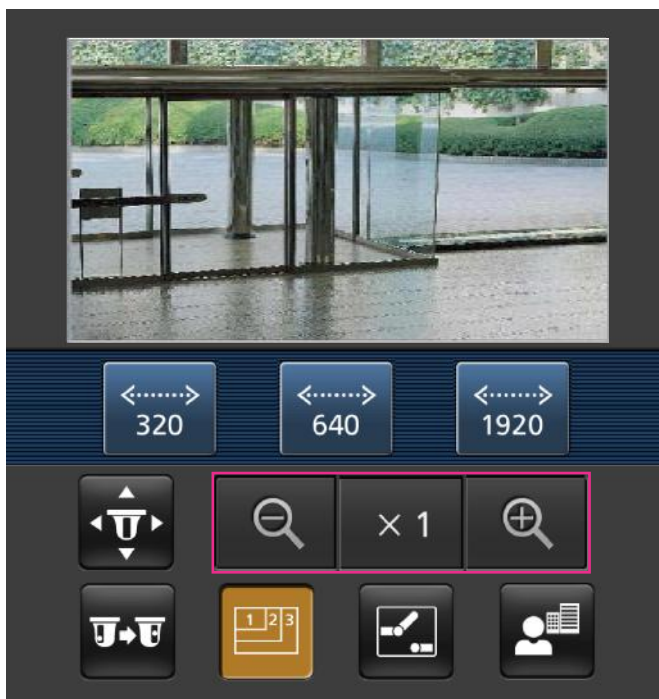

**Note**

- You can change the image size displayed on the mobile terminal by accessing the following addresses.
  - Large display: `http://IP address/cam/dl`
  - Medium display: `http://IP address/cam/dm`
  - Small display: `http://IP address/cam/ds`
- When the resolution is changed by the resolution control, the displayed resolution changes but the image size remains the same.
- When the HTTP port number is changed from “80”, enter “`http://IP address: (colon) + port number/cam`”<sup>1</sup> in the address box of the browser. When using the DDNS function, access to “`http://Host name registered in the DDNS server: (colon) + port number/cam`”<sup>2</sup>.
- When “HTTPS” is selected for “HTTPS” - “Connection” on the [Advanced] tab of the “Network” page, enter as follows.  
“`https://IP address: (colon) + port number/cam`” or “`https://Host name registered in the DDNS server: (colon) + port number/cam`”
- When the authentication window is displayed, enter the user name of an administrator or user and password. Depending on the mobile terminal in use, password entry may be required each time the screen is switched.
- It is impossible to send and receive audio using a mobile terminal.
- Depending on the mobile terminal in use, larger size images may not be displayed. In this case, selecting a setting close to the lowest quality setting for “Image quality setting” of “JPEG” (→page 96) may sometimes solve this problem.
- Depending on the mobile terminal in use or its contract plan, it may be impossible to access.

---

<sup>1</sup> IP address is the global WAN IP address of the router that can be accessed via the Internet. However, when accessing the same LAN as the camera with a wireless compatible mobile terminal, the IP address is the local IP address.

<sup>2</sup> Only when accessing the camera via the Internet.

## 1.3 Record images on the SD memory card manually

Images displayed on the “Live” page can be recorded on the SD memory card manually. This button is operable only when “Manual” is selected for “Save trigger” on the [SD memory card] tab on the “Basic” page of the setup menu. (→page 81)

It is possible to select “JPEG(1)”, “JPEG(2)”, “JPEG(3)”, “Stream(1)”, “Stream(2)”, “Stream(3)”, or “Stream(4)” on “Recording format” of the setup menu. (→page 80) When “JPEG” is selected for “Recording format”, still image data are recorded. When “Stream(1)”, “Stream(2)”, “Stream(3)”, or “Stream(4)” is selected, video data are recorded.

Images recorded on the SD memory card can be copied onto the PC. (→page 91)

1. Display the “Live” page. (→page 9)



2. Click the [Rec. on SD] button.  
→ The SD recording window will open.

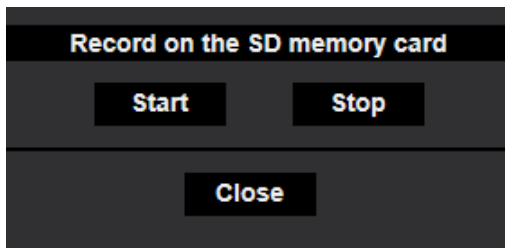

3. Click the [Start] button to start recording images on the SD memory card. The SD recording status indicator will light red (→page 12) while images are being recorded on the SD memory card. The image saving interval can be configured on the [SD memory card] tab of the “Basic” page. (→page 78)
4. Click the [Stop] button to stop saving images on the SD memory card.  
→ The SD recording status indicator will turn off.
5. Click the [Close] button to close the window.

### Note

- Image data saved on Drive B can be obtained by executing “Access img.” on the [SD memory card] tab and logging in from the user authentication window (→page 91). The destination to save image data is a fixed directory on Drive B (→page 271).

- When the [Start] button is clicked immediately after the [Stop] button is clicked, saving of images may not start. In this case, click the [Start] button again.

## 1.4 Action at an alarm occurrence

The alarm action (camera action at an alarm occurrence) will be performed when the following alarms occur.

### 1.4.1 Alarm type

- **Terminal alarm:** When connecting an alarm device such as a sensor to the alarm input terminal of the camera, the alarm action will be performed when the connected alarm device is activated.
- **VMD alarm:** When motion is detected in the set VMD area, the alarm action will be performed.  
\*VMD stands for “Video Motion Detection”.
- **Command alarm:** When a Panasonic alarm protocol is received from the connected device via a network, the alarm action will be performed.
- **Auto track alarm:** According to the conditions set in advance, the alarm action will be performed in the auto tracking operations.
- **Audio detection alarm:** When the configured audio detection level is exceeded, the alarm action will be performed.

### 1.4.2 Action at an alarm occurrence

#### Display the alarm occurrence indication button on the “Live” page

The alarm occurrence indication button will be displayed on the “Live” page at an alarm occurrence.  
(→page 12)

#### **IMPORTANT**

- When “Polling(30s)” is selected for “Status update mode” (→page 71), the Alarm occurrence indication button will be refreshed in 30-second intervals. For this reason, it may take a maximum of 30 seconds until the alarm occurrence indication button is displayed on the “Live” page at an alarm occurrence.

#### Notify of alarm occurrences to the device connected to the output terminal

It is possible to output signals from the output terminal of the camera and sound the buzzer when an alarm occurs. The settings for the alarm output can be configured in the [Alarm] tab of the “Alarm” page.  
(→page 154)

#### Save images on the SD memory card

When an alarm occurs, images (JPEG/H.265/H.264) will be saved on the SD memory card. The settings to save images on the SD memory card can be configured on the [SD memory card] tab (→page 78) of the “Basic” page and the [Alarm] tab of the “Alarm” page. (→page 156)

#### Transmit an image onto a server automatically

An alarm image can be transmitted at an alarm occurrence to the server designated in advance. The settings required to transmit an alarm image to a server can be configured in the “Alarm image” section on the [Alarm] tab of the “Alarm” page (→page 156) and the [Advanced] tab of the “Network” page (→page 196).



## Notify of alarm occurrences by E-mail

Alarm E-mail (alarm occurrence notification) can be sent at an alarm occurrence to the E-mail addresses registered in advance. Up to 4 addresses can be registered as recipients of the alarm E-mail. An alarm image (still picture) can be sent with the alarm E-mail as an attached file. The settings for alarm E-mail can be configured in the “Alarm E-mail notification” section on the [Alarm] tab of the “Alarm” page (→page 156) and the [Advanced] tab of the “Network” page (→page 191).

## Notify of alarm occurrences to the designated addresses (Panasonic alarm protocol notification)

This function is available only when a Panasonic device, such as the network disk recorder, is connected to the system. When “On” is selected for “Panasonic alarm protocol”, the connected Panasonic device will be notified that the camera is in the alarm state. The settings for Panasonic alarm protocol can be configured in the “Panasonic alarm protocol notification” section of the [Notification] tab of the “Alarm” page. (→page 173)

## Notify of alarm occurrences to the designated HTTP server (HTTP alarm notification)

Alarm occurrence notifications can be sent at an alarm occurrence to the HTTP servers registered in advance. Up to 5 HTTP servers can be registered as recipients of alarm notifications. The URL sent to HTTP servers with alarm notifications can be specified. The settings for HTTP alarm notification can be configured on the [Notification] tab of the “Alarm” page. (→page 175)

## 1.5 Transmit images onto an FTP server

Images can be transmitted to an FTP server. By configuring the following settings, transmission of images captured at an alarm occurrence or captured at a designated interval to an FTP server will become available.

### **IMPORTANT**

- When using this function, set the user name and the password to access the FTP server to restrict users who can log into the FTP server.

### 1.5.1 Transmit an alarm image at an alarm occurrence (Alarm image transmission)

An alarm image can be transmitted at an alarm occurrence to the FTP server. To transmit alarm images to an FTP server, it is necessary to configure the settings in advance.

FTP server settings and settings relating to alarm image transmission can be configured in the “FTP” section of the [Advanced] tab of the “Network” page. (→page 196) Settings can also be configured from the “Alarm image FTP transmission” settings of “Camera action on alarm” on the [Alarm] tab of the “Alarm” page. (→page 156)

#### **Note**

- Depending on the network traffic, the number of the transmitted images may not reach the set number of images to be transmitted.
- Alarm images failed to be transmitted to the FTP server at an alarm occurrence will not be saved on the SD memory card. However, images that fail to be transmitted with the FTP periodic image transmission will be saved.

When “On” is selected for both the alarm image transmission function and the FTP periodic image transmission function, the alarm image transmission function will be given priority over the FTP periodic image transmission function. Also, when “On” is selected for the “FTP transmission retry” FTP setting (→page 197), alarm images will be retransmitted if there is an FTP transmission failure. Therefore, if there is continuous retransmission due to network problems or other factors, periodic transmission will not be performed and images that fail to be transmitted with the FTP periodic image transmission will not be saved to an SD memory card.

### 1.5.2 Transmit images at a designated interval or period (FTP periodic image transmission)

Images can be transmitted at a designated interval or period. To transmit images at a designated interval or period, it is necessary to configure the settings in advance.

FTP server settings and settings relating to FTP periodic transmission image transmission can be configured in the “FTP” section of the [Advanced] tab of the “Network” page. (→page 196)

When using FTP periodic image transmission, it is necessary to configure the schedule settings of FTP periodic image transmission on the [Schedule] tab of the “Schedule” page.

Configure the schedule settings of the FTP periodic image transmission on the “Schedule” page. (→page 235)

#### **Note**

- Depending on the line speed or the traffic, images may not be transmitted at the designated interval.
- When “On” is selected for both the alarm image transmission function and the FTP periodic image transmission function, the alarm image transmission function will be given priority over the FTP periodic

image transmission function. Therefore, images may not be transmitted at the interval designated on the “FTP periodic image transmission” setting.

### 1.5.3 Save images on the SD memory card when images fail to transmit using the FTP periodic image transmission function

Images that have failed to transmit using the FTP periodic image transmission can be saved automatically on the SD memory card. It is possible to select a trigger to save images on the SD memory card on the [SD memory card] tab of the “Basic” page. (→page 78)

To use the SD memory backup function featured in Panasonic network disk recorder select “Off” for “FTP periodic image transmission” (→page 198) and “FTP periodic image transmission error” for “Save trigger” of “Recording stream 1” (→page 81).

#### **Note**

- When “On” is selected for both the alarm image transmission function and the FTP periodic image transmission function, the alarm image transmission function will be given priority over the FTP periodic image transmission function. Also, when “On” is selected for the “FTP transmission retry” FTP setting (→page 196), alarm images will be retransmitted if there is an FTP transmission failure. Therefore, if there is continuous retransmission due to network problems or other factors, periodic transmission will not be performed and images that fail to be transmitted with the FTP periodic image transmission will not be saved to an SD memory card.

#### **IMPORTANT**

- We make no guarantee for any damages of files on the SD memory card incurred by malfunction or error occurrence in files saved in the SD memory card regardless of what the cause may be.

## 1.6 Display the log list

The history of various logs will be displayed in list form.

- **Alarm log:** Logs of the alarm occurrences such as time and date of the alarm occurrences, the image recording period and the alarm type will be displayed.
- **Manual/Schedule log:** Logs filed when images have been recorded manually or during the period of the schedule, and the image recording period will be displayed.
- **FTP trans. error log:** Logs filed when the FTP periodic image transmission function has failed will be displayed.

1. Display the “Live” page.



## 2. Click the [Log] button.

→ The log list will be displayed in a newly opened window (log list window).

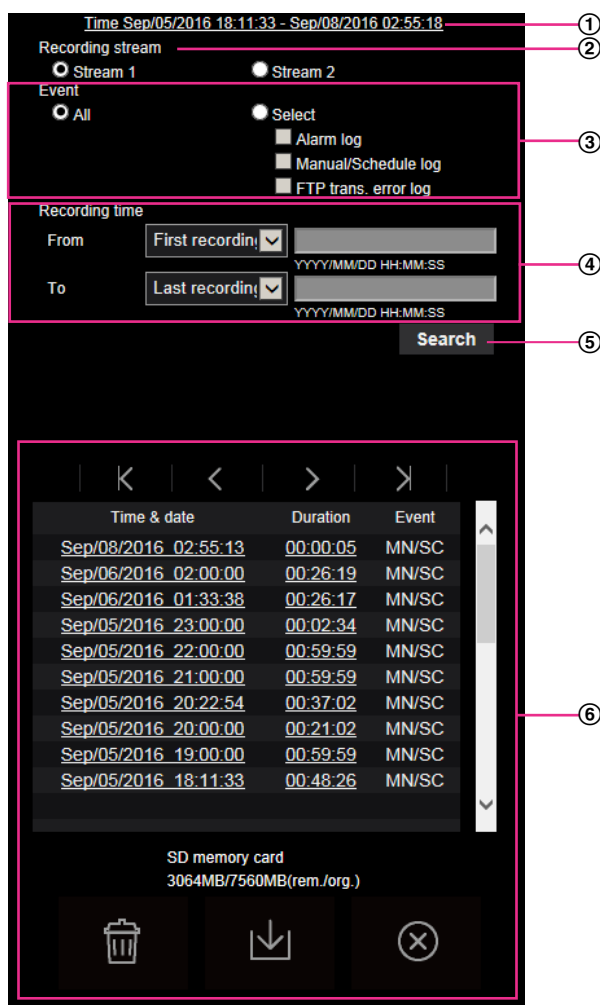
**IMPORTANT**

- Only a single user can operate the log list window. Other users cannot access the log list window.

① **Time**

Displays the time period of the data recorded on the SD memory card.

② **Recording stream**

Select the recording stream that you want to display logs for.

- **Stream 1:** The logs recorded by “Recording stream 1” on the [SD memory card] tab will be displayed.
- **Stream 2:** The logs recorded by “Recording stream 2” on the [SD memory card] tab will be displayed.

③ **Event**

Select a log type to display on the log list.

- **All:** All logs will be displayed.
- **Select:** Only the logs of the selected log type will be displayed.
  - **Alarm log:** The log when an alarm is detected will be displayed.
  - **Manual/Schedule log:** Manual and Schedule logs will be displayed.
  - **FTP trans. error log:** Logs filed when the FTP periodic image transmission function has failed will be displayed.
- **Default:** All

**Note**

- When “Stream 1” is selected for “Recording stream” and either “JPEG(1)”, “JPEG(2)”, or “JPEG(3)” is selected for “Stream 1”, the FTP trans. error log will be displayed.

④ **Recording time**

Configure the time period of logs displayed on the log list.

- **From:** Configure the starting period of logs displayed on the log list.
  - **First recording:** Displays from the first log recorded on the SD memory card.
  - **Today:** Displays the logs recorded today.
  - **Yesterday:** Displays the logs recorded from yesterday to the present day.
  - **Last 7 days:** Displays the logs recorded from 6 days ago to the present day.
  - **Last 30 days:** Displays the logs recorded from 29 days ago to the present day.
  - **Date/time:** Displays the logs recorded from the entered date and time on “Date/time” box.
- **To:** Configure the ending period of logs displayed on the log list when “First recording” or “Date/time” is selected for “From”.
  - **Last recording:** Displays until the last log recorded on the SD memory card.
  - **Date/time:** Displays the logs recorded until the entered date and time on “Date/time” box.

⑤ **[Search] button**





Searches for logs according to the conditions specified in “Event” and “Recording time”.

The search result will be displayed on the log list.

⑥ **Log list**

Displays the log search results.

You can play back recorded data by clicking on the time or duration of the recorded data displayed under [Time & date] and [Duration].

-  **(Top) button:** Click this button to display the log listed at the top.
-  **(Prev. page) button:** Click this button to display the previous page of the log list.
-  **(Next page) button:** Click this button to display the next page of the log list.
-  **(Last) button:** Click this button to display the log listed at the bottom.
- **[Time & date]:** Time and date when each log has been recorded will be displayed.

**Note**



- When “Off” is selected for “Time display format”, the alarm occurrence times are displayed in 24 hour time format.
- The recording timing of logs is as follows.
  - **Alarm log:** Alarm occurrence time and date will be filed as a log.
  - **Manual/Schedule log:** Time and date when recording of images onto the SD memory card started manually or during the period of the schedule will be filed as a log. When images are recorded sequentially, if “JPEG” is selected for “Recording format”, logs will be filed on the hour every hour (12:00, 1:00, 2:00, etc.). If “Stream” is selected for “Recording format”, logs will be filed every hour from the time when recording starts.
  - **FTP trans. error log:** Logs will be filed every one hour.
- **[Duration]:** Displays the period of time that the data has been recorded on the SD memory card.

**Note**

- The difference between the recording end time and recording start time of the image is calculated by rounding off to the nearest tenth of a second. For this reason, when only 1 JPEG image is saved, 00:00:00 is displayed for the duration.
- **[Event]:** The event type will be displayed.
  - **MN/SC:** Log by “Manual/Schedule”

- **TRM1:** Alarm by alarm input to Terminal 1
- **TRM2:** Alarm by alarm input to Terminal 2
- **TRM3:** Alarm by alarm input to Terminal 3
- **VMD:** Alarm by VMD alarm
- **COM:** Alarm by command alarm
- **AT:** Alarm detected by auto track alarm
- **AUD:** Alarm by audio detection alarm
- **FTP:** Logs saved from FTP periodic image transmission errors
- **[SD memory card]:** Available capacity and the original capacity of the SD memory card will be displayed.
-  **(Delete) button:** Deletes log lists from all pages. When logs are searched for, only the searched logs are deleted. Images associated with deleted logs will also be deleted.

### **IMPORTANT**

- If there are many recorded data files on the SD memory card, it may take time to delete all of them. (For example, when the total size is 1 GB, it may take about 1 hour to delete the files.) In this case, format the SD memory card. However, please note that formatting will delete all of the files on the SD memory card.
- In the process of the deletion, “Alarm” and “Manual/Schedule” cannot be operated.
- Do not turn off the power of the camera until the deletion is complete. When the power of the camera is turned off in the process of the deletion, some images may remain on the SD memory card. In this case, click the  button on the same log list window used to delete the logs.
-  **(Download) button:** Click this button to download all logs of the selected log list onto the PC.

### **Note**

- The following settings may be required.  
Open Internet Explorer, click [Tools] → [Internet Options] → [Security] → [Trusted Sites] → [Sites]. Register the camera address on [Website] of the displayed trusted windows.  
After registration, close the web browser, and then access the camera again.
- Up to 50,000 logs will be downloaded to the SD memory card. When more than 50,000 logs are filed, the older logs will be overwritten by the newer logs. In this case, the oldest log is the first to be overwritten.  
If there are many logs, it may take time to download the logs.
-  **(Close) button:** Click this button to close the log list window.

## 1.7 Playback of images on the SD memory card

When clicking a time and date listed on the log list window, the “Live” page will turn to the “Playback” page. When images associated with the clicked time and date are on the SD memory card, the first image of them will be displayed.

The display format varies depending on the “Recording format” of the SD memory card.

### IMPORTANT

- Refresh interval of images may become slow during playback or download.
- When many images are saved on the SD memory card, it may take time to display images on the “Playback” page.
- When the aspect ratio is “4:3”, images will be displayed in VGA size on the “Playback” page regardless of the image capture size of the images saved on the SD memory card. When the aspect ratio is “16:9”, images will be displayed in “640x360” on the “Playback” page regardless of the image capture size of the images saved on the SD memory card. Therefore, images may look coarse on the “Playback” page.
- When playing images by selecting an FTP error log on the log list, images may not be played in order of images recorded on the SD memory card if they have been recorded on the SD memory card with selected value for the “Transmission interval” setting of “FTP periodic image transmission” on the [Advanced] tab is “1min” or less.
- The playback refresh interval may become slower when recording data to the SD memory card.

### 1.7.1 Playback “JPEG(1)”/“JPEG(2)”/“JPEG(3)” images saved to the SD memory card



① Number of images

When clicking a time and date listed on the log list window, total number of images associated with the clicked time and date, and the number of the currently displayed image will be displayed.





**Note**

- Enter the desired number of image and press the [Enter] key on the keyboard. The image of the designated number will be displayed.

** (REW) button**

Each time the button is clicked, the playback speed will change.

When the  button or the  button is clicked during fast reverse playback, playback speed will return to the normal playback speed.

** (REV PLAY) button**



Images will be played in reverse sequential order.

** (PLAY) button**

When this button is clicked, images will be played in sequential order.

** (FF) button**

Each time the button is clicked, the playback speed will change.

When the  button or the  button is clicked during fast playback, playback speed will return to the normal playback speed.

** (TOP) button**

The first image will be displayed.

** (PREV. IMAGE) button**

The previous frame will be displayed and paused when this button is clicked during playback.

Each time this button is clicked during pausing, the frame previous to the currently displayed frame will be displayed.

**Note**

- When the mouse button is held down while the mouse pointer is on this button, the image number will be decreased.  
When the mouse button is released, the decreasing of the image number will stop and the image corresponding to the currently displayed number will be displayed.

** (PAUSE) button**

Playback will be paused when this button is clicked during playback.

Playback will resume when this button is clicked during pausing.

** (STOP) button**

Playback will stop and the “Playback” window will turn to the “Live” page.

** (NEXT IMAGE) button**

The next frame will be displayed and paused when this button is clicked during playback.

Each time this button is clicked during pausing, the frame next to the currently displayed frame will be displayed.

**Note**

- When the mouse button is held down while the mouse pointer is on this button, the image number will be increased.  
When the mouse button is released, the increment of the image number will stop and the image number displayed at the moment when the mouse button is released will be displayed.

 **(LAST) button**

The last image will be displayed.

 **(Start) button**

The selected image will be downloaded onto the PC. Before downloading images, designate the destination directory in advance. (→page 93)

The following window will be displayed when the  button is clicked.

Select the image to be downloaded, and then click the [OK] button.

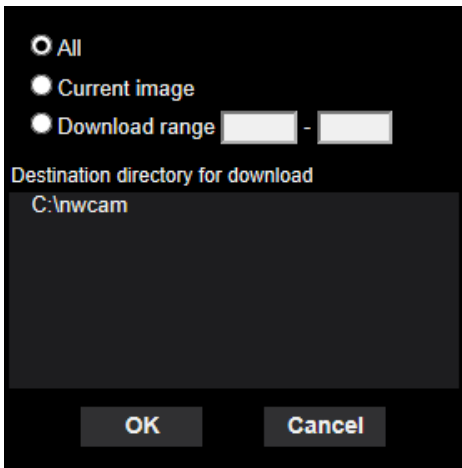

- **All:** All images saved at the selected time and date will be downloaded.
- **Current image:** Only the currently displayed image will be downloaded.
- **Download range:** Images in the specified range will be downloaded.

**Note**

- When the [Cancel] button is clicked in the process of the download, the download will be canceled. In this case, images already downloaded before clicking the [Cancel] button will be saved on the PC.

 **(Browse) button**

When successfully logged in after the user authentication process, a folder on the SD memory card in which images are saved will be displayed. (→page 91)

**Note**

- FTP access to camera must be allowed.  
Select "Allow" for "FTP access to camera" on the [Network] tab.

## 1.7.2 Playback “Stream(1)”/“Stream(2)”/“Stream(3)”/“Stream(4)” images saved to the SD memory card

### **IMPORTANT**

- Depending on the network environment, download of video data may fail. If downloading failed while playing images, you may be able to download images after stopping the currently played images and starting the download again.
- Depending on the network environment and status of the camera, you may not be able to operate each operation on this screen consecutively.



#### ① Slider bar

By operating the slider bar, you can select where to start playing images from. The slider bar can only be used before playing images, or when playing is paused or stopped.

#### **⏸ (PAUSE) button**

Playback will be paused when this button is clicked during playback.

#### **▶ (PLAY) button**

When this button is clicked, recorded data will be played.

#### **Note**

- If audio is recorded, it can be played back, but the image and audio will not be synchronized. Therefore, images and audio may not always match. When data is being recorded to the SD memory card, audio may sound as if it is cutting out and the audio quality may be reduced.
- When recorded audio is played back, the refresh interval of live images and playback may become slow.
- Recorded audio is not played back when “Off” or “Interactive(Half-duplex)” is selected for “Audio transmission mode” on the [Audio] tab of the “Image/Audio” page.

### (FF) button

Each time this button is clicked, the playback speed will change. When the  button is clicked during fast playback, playback speed will return to the normal playback speed.

#### **Note**

- The maximum speed of the fast playback varies depending on the setting of “Bit rate” of the stream selected with “Recording format” of the SD memory card.  
Also, if “Transmission priority” and “Max bit rate (per client)” in the [Image] tab are set as in the following, the fast playback is not available and the images will be played in the normal speed.
  - When “Constant bit rate”, “VBR”, or “Best effort” is selected for “Transmission priority”, and “16384kbps” or more is set for “Max bit rate (per client)”
  - When “Frame rate” is selected for “Transmission priority” and “Fine(Image quality priority)” is selected for “Image quality”, as well as “14336kbps” is set for “Max bit rate (per client)”
  - When “Frame rate” is selected for “Transmission priority” and “Normal” is selected for “Image quality”, as well as “10240kbps” is set for “Max bit rate (per client)”
  - When “Frame rate” is selected for “Transmission priority” and “Low(Motion priority)” is selected for “Image quality”, as well as “8192kbps” is set for “Max bit rate (per client)”
- Recorded audio will not be played back during fast playback.

### (5s backward) button

Each time this button is clicked, the recorded data goes back by 5 seconds and starts playing.

### (5s forward) button

Each time this button is clicked, the recorded data goes forward by 5 seconds and starts playing.

### (STOP) button

Playback will stop and the “Playback” window will turn to the “Live” page.

#### **[Time & date]**

Time and date when each log has been recorded will be displayed.

#### **[Duration]**

Displays the period of time that the data has been recorded on the SD memory card.

#### **[Event]**

The event type will be displayed.

- **MN/SC:** Log by “Manual/Schedule”
- **TRM1:** Alarm by alarm input to Terminal 1
- **TRM2:** Alarm by alarm input to Terminal 2
- **TRM3:** Alarm by alarm input to Terminal 3
- **VMD:** Alarm by VMD alarm
- **COM:** Alarm by command alarm
- **AT:** Alarm detected by auto track alarm
- **AUD:** Alarm by audio detection alarm

### (Start) button

The selected image will be downloaded onto the PC.

Before downloading images, designate the destination directory in advance. (→page 93)

The message window will be displayed to ask if it is OK to start download when the  button is clicked. Click the [OK] button.

**Note**

- The image playing screen cannot be operated while downloading. Perform operations after the downloading is completed.
- When the [Cancel] button is clicked in the process of the download, the download will be canceled. In this case, video data already downloaded before clicking the [Cancel] button will be saved on the PC.
- Video data are saved in the files of approx. 20 MB. When the file size of video data is more than 20 MB, two or more files will be downloaded.
- It is possible to play back H.264 video data saved on the PC using such applications as Windows Media Player. However, we are not liable for performance relating to these applications.
- Depending on the status of the SD memory card or Windows Media Player, H.264 video data cannot be played back.

For information on playing back H.265 video data, refer to the following Panasonic website below.  
<https://security.panasonic.com/support/info/>

## 2 Settings

### 2.1 About the network security

#### 2.1.1 Equipped security functions

The following security functions are featured in this camera.

- ① Access restrictions by the host authentication and the user authentication  
It is possible to restrict users from accessing the camera by setting the host authentication and/or the user authentication to "On". (→page 177, page 180)
- ② Access restrictions by changing the HTTP port  
It is possible to prevent illegal access such as port scanning, etc. by changing the HTTP port number. (→page 188)
- ③ Access encryption by the HTTPS function  
It is possible to enhance the network security by encrypting the access to cameras using the HTTPS function. (→page 209)

#### **IMPORTANT**

- Design and enhance security countermeasures to prevent leakage of information such as image data, authentication information (user name and password), alarm E-mail information, FTP server information, DDNS server information, etc. Perform the countermeasure such as access restriction (using the user authentication) or access encryption (using the HTTPS function).
- After the camera is accessed by the administrator, make sure to close the browser for added security.
- Change the administrator password periodically for added security.

#### **Note**

- When user authentication (authentication error) has failed to pass 8 times within 30 seconds using the same IP address (PC), access to the camera will be denied for a while.

## 2.2 Display the setup menu from a PC

The settings of the camera can be configured on the setup menu.

### **IMPORTANT**

- The setup menu is only operable by users whose access level is “1. Administrator”. Refer to page 177 for how to configure the access level.

### 2.2.1 How to display the setup menu

1. Display the “Live” page. (→page 9)
2. Click the [Setup] button on the “Live” page.  
→ The window with the user name and password entry fields will be displayed.



3. Click the [OK] button after entering the user name and the password.  
→ The setup menu will be displayed. Refer to page 49 for further information about this menu.

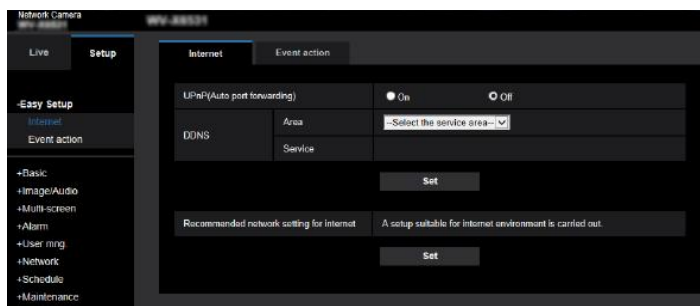

## 2.2.2 How to operate the setup menu

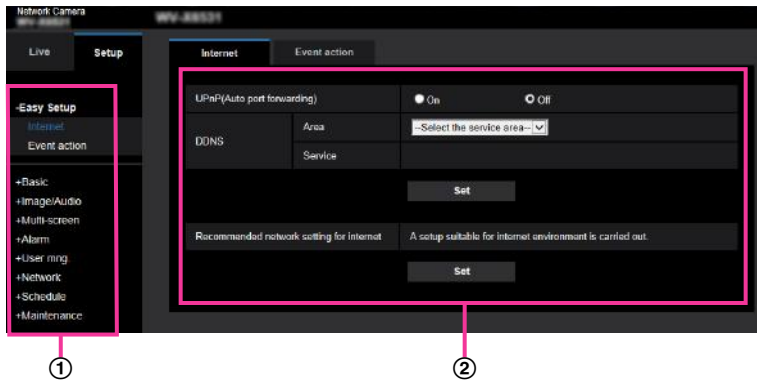

- ① Menu buttons
- ② Setup page

1. Click the desired button in the frame on the left of the window to display the respective setup menu. When there are tabs at the top of the “Setup” page displayed in the frame on the right of the window, click the desired tab to display and configure the setting items relating to the name of the tab.
2. Complete each setting item displayed in the frame on the right of the window.
3. After completing each setting item, click the [Set] button to apply them.

### IMPORTANT

- When there are two or more [Set], [Register], and [Execute] buttons on the page, click the respective button to the edited setting item.

#### <Example>

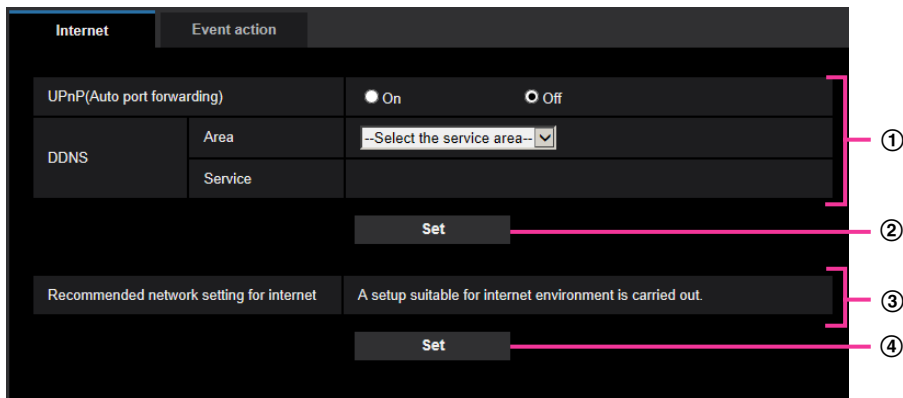

When completing the setting items in field ①, click the [Set] button ② below field ①). The edited settings in field ① will not be applied unless the [Set] button ② below field ①) is clicked. In the same manner as above, click the [Set] button ④) below field ③) when completing the setting items in field ③).



## 2.2.3 About the setup menu window

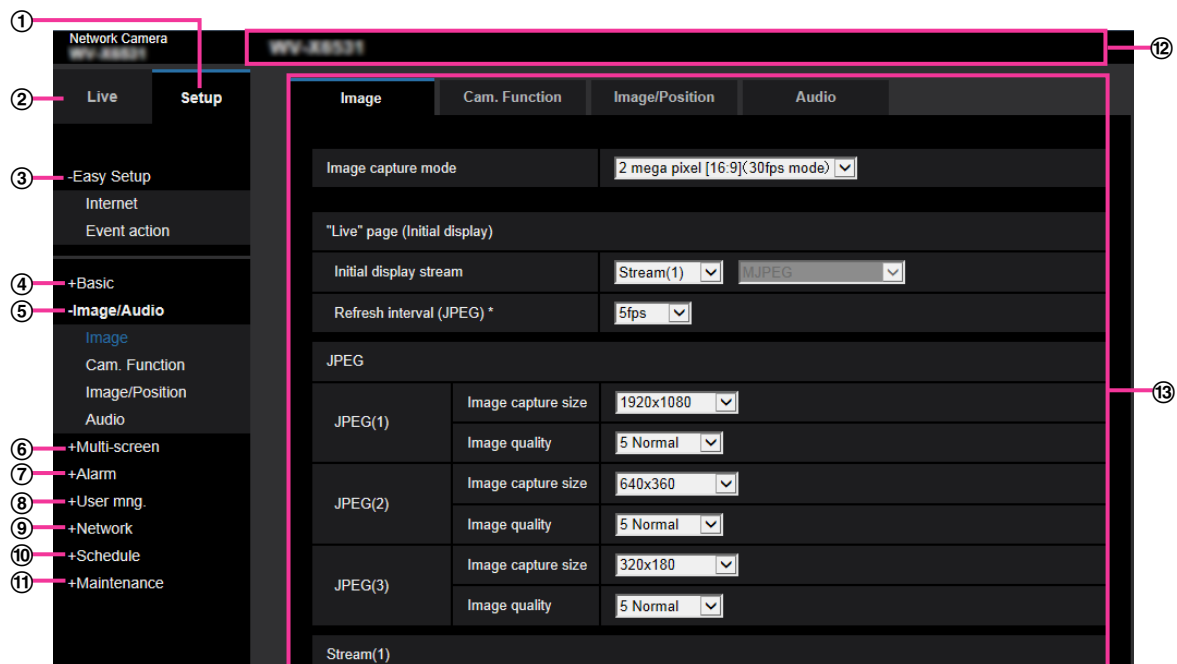

- ① **[Setup] button**  
Display the “Setup” page.
- ② **[Live] button**  
Display the “Live” page.
- ③ **[Easy Setup] button**  
Displays the “Easy Setup” page. The “Easy Setup” page is used to set the connectivity to the Internet, as well as to set event actions such as alarm settings and camera action on alarm. (→page 51)
- ④ **[Basic] button**  
Displays the “Basic” page. The basic settings such as time and date and camera title, and the settings relating to the SD memory card can be configured on the “Basic” page. (→page 71)
- ⑤ **[Image/Audio] button**  
Displays the “Image/Audio” page. The settings relating to image quality, image capture size, etc. of JPEG/H.265/H.264 camera images can be configured on the “Image/Audio” page. (→page 95)
- ⑥ **[Multi-screen] button**  
Displays the “Multi-screen” page. The cameras from which images are to be displayed on a multi-screen can be registered on the “Multi-screen” page. (→page 150)
- ⑦ **[Alarm] button**  
Displays the “Alarm” page. The settings relating to alarm occurrences such as settings for the alarm action at an alarm occurrence, the alarm occurrence notification, and the VMD area settings can be configured on the “Alarm” page. (→page 152)
- ⑧ **[User mng.] button**  
Displays the “User mng.” page. The settings relating to the authentication such as users and PCs restrictions for accessing the camera can be configured on the “User mng.” page. (→page 177)
- ⑨ **[Network] button**  
Displays the “Network” page. The network settings and the settings relating to DDNS (Dynamic DNS), SNMP (Simple Network Management Protocol), FTP (File Transfer Protocol), the NTP server, and QoS can be configured on the “Network” page. (→page 185)

- ⑩ **[Schedule] button**  
Displays the “Schedule” page. On the “Schedule” page, it is possible to designate time zones to allow to activate the VMD detection function. (→page 232)
- ⑪ **[Maintenance] button**  
Displays the “Maintenance” page. System log check, firmware upgrade, status check and initialization of the setup menu can be carried out on the “Maintenance” page. (→page 239)
- ⑫ **Camera title**  
The title of the camera whose settings are currently being configured will be displayed.
- ⑬ **Setup page**  
Pages of each setup menu will be displayed. There are tabs for some setup menus.  
The bottom of the settings page has been omitted.

## 2.3 Use Easy Setup [Easy Setup]

The “Easy Setup” page uses simple operations to set the following:

- Make the camera image available on the Internet
- Set event actions such as recording of a schedule/alarm to the SD memory card

The “Easy Setup” page consists of the [Internet] tab and [Event action] tab.

### 2.3.1 Configure the Internet settings [Internet]

Click the [Internet] tab of the “Easy Setup” page. (→For menu display and how to operate, refer to page 47, page 48)

The settings relating to UPnP (Auto port forwarding), DDNS (Viewnetcam.com), and network settings for the Internet can be configured on this page.

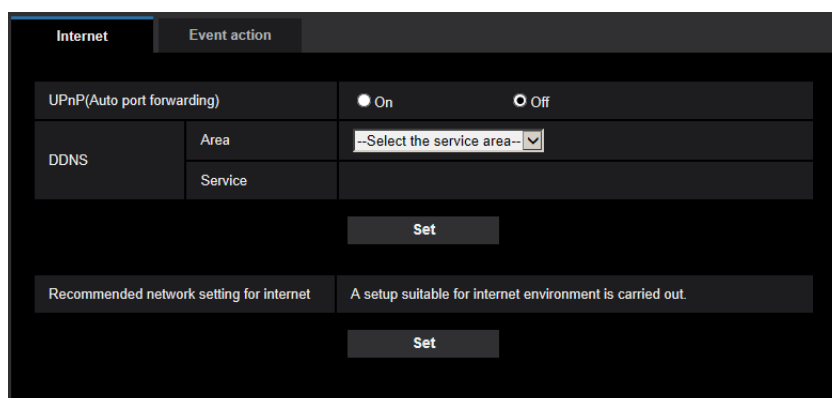

#### [UPnP (Auto port forwarding)]

Select “On” or “Off” to determine whether or not to use the port forwarding function of the router.

To use the auto port forwarding function, the router in use must support UPnP and the UPnP must be enabled.

- **Default:** Off

#### **Note**

- Due to auto port forwarding, the port number may sometimes be changed. When the number is changed, it is necessary to change the port numbers registered in the PC and recorders, etc.
- The UPnP function is available when the camera is connected to the IPv4 network. IPv6 is not supported.
- To check if auto port forwarding is properly configured, click the [Status] tab on the “Maintenance” page, and check that the “Enable” is displayed for “Status” of “UPnP”. (→page 241)  
When “Enable” is not displayed, refer to “Cannot access the camera via the Internet.” in 3.3 Troubleshooting.
- When the “UPnP (Auto port forwarding)” setting is changed, the “Auto port forwarding” setting under “UPnP” on the [Advanced] tab of the “Network” page also changes to the same setting.

#### [Area]

Select the region where the camera is installed.

Global/Japan

### Note

- If the camera is used in Japan, select “Japan”. If the camera is used outside of Japan, select “Global”. The “Viewnetcam.com” service that is displayed when “Global” is selected cannot be used in Japan.

### [Service]

Select “Viewnetcam.com” or “Off” to determine whether or not to use “Viewnetcam.com”.

By selecting “Viewnetcam.com” and clicking the [Set] button, the registration window for “Viewnetcam.com” will be displayed in a newly opened window.

Follow the on-screen instructions to register with “Viewnetcam.com”.

Refer to page 228 or the “Viewnetcam.com” website (<http://www.viewnetcam.com/>) for further information.

- **Default:** Off

### Note

- When the “DDNS” setting is changed, the “DDNS” setting on the [Advanced] tab of the “Network” page also changes to the same setting.

### [Recommended network setting for internet]

The recommended settings for connecting to the Internet are performed here.

By clicking the [Set] button, a dialog displaying how the following settings will change is displayed.

Click the [OK] button after checking the settings to change the settings to the displayed values.

- [Image] tab on the “Image/Audio” page
  - [JPEG(1)]**  
[Image capture size]: VGA/640x360
  - [JPEG(2)], [JPEG(3)]**  
[Image capture size]: QVGA/320x180
  - [Stream(1)],[Stream(2)],[Stream(3)],[Stream(4)]**  
[Internet mode (over HTTP)]: On  
[Transmission priority]: Best effort  
[Max bit rate (per client)\*]: 1024 kbps
  - [Stream(1)]**  
[Image capture size]: 1280x960/1280x720
  - [Stream(2)]**  
[Image capture size]: VGA/640x360
  - [Stream(3)], [Stream(4)]**  
[Image capture size]: QVGA/320x180
- [Network] tab on the “Network” page
  - [Common]**  
[Max RTP packet size]: Limited(1280byte)  
[HTTP max segment size(MSS)]: Limited(1280byte)

## 2.3.2 Configure an event action [Event action]

Click the [Event action] tab in the “Easy Setup” page. (→For menu display and how to operate, refer to page 47, page 48)

The current settings are displayed here.

[Current settings]

Alarm	
Alarm condition	Off
Alarm	Off
Output terminal	Off
E-mail notification	Off

Schedule	
Schedule	Off

Next

You can set event actions for SD schedule recording/FTP periodic image transmission/alarm detection. Once the settings are completed in each setup menu, click the [Next] button to proceed. The setup flow is as follows.

#### **Note**

- If you click the [Next] button, the settings in the screen will be saved.
- When “2 mega pixel [16:9](60fps mode)” or “1.3 mega pixel [16:9](60fps mode)” is selected for “Image capture mode”, functions related to SD memory cards are not available.

## Flow of event action setup

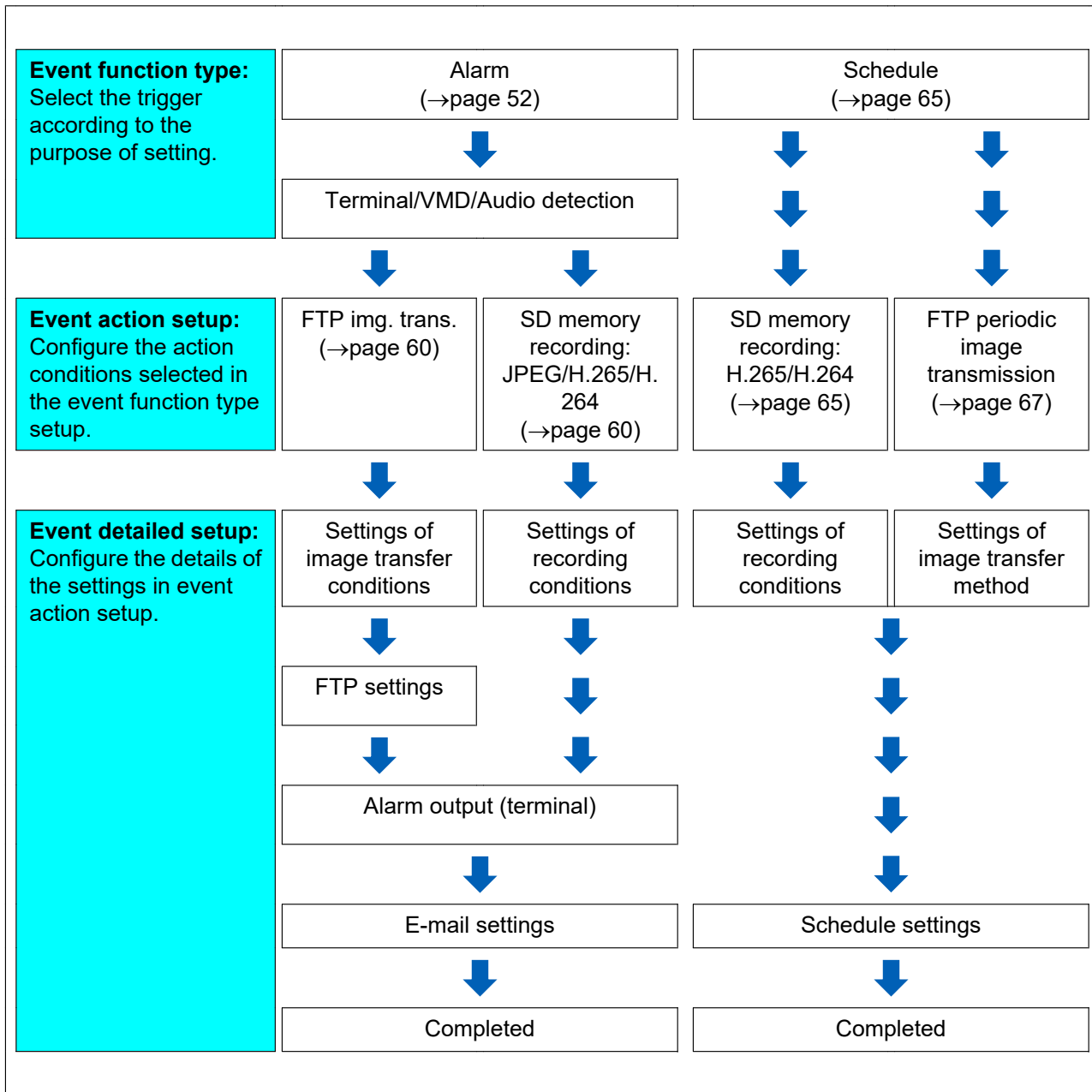

## 2.3.2.1 Configure the schedule/alarm (event function type setup menu)

Here, select the function type of the event.

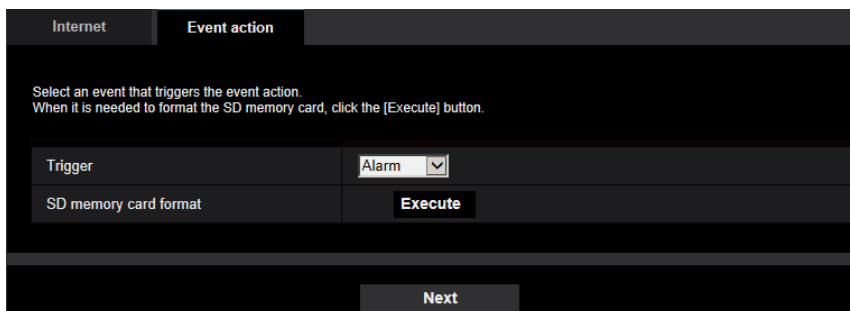

### [Trigger]

- **Alarm:** Select when setting the alarm detection settings.
- **Schedule:** Select during “SD memory recording” or “FTP periodic image transmission”.
- **Default:** Alarm

### [SD memory card format]

To format the SD memory card, click the [Execute] button.

Once you click the [Execute] button, the “Format” confirmation screen will be displayed.

If you click the [OK] button, the formatting will start.

Once the “Format” completion screen is displayed, press the  button.

### **IMPORTANT**

- All data saved on the SD memory card will be deleted when the SD memory card is formatted.
- Do not turn off the power of the camera during formatting.

### [Next] button

If you select “Alarm”, and click the [Next] button, the alarm setup menu will be displayed. (→page 56)

If you select “Schedule”, and click the [Next] button, the schedule function type setup menu will be displayed.

(→page 65)

### 2.3.2.2 Alarm: Configure the terminal and VMD (alarm setup menu)

The settings relating to actions when an alarm is detected can be configured in this section.

Alarm	
Terminal 1	<input type="text" value="Off"/>
Terminal 2	<input type="text" value="Off"/>
Terminal 3	<input type="text" value="Off"/>
VMD alarm	<input checked="" type="radio"/> On <input type="radio"/> Off
Auto track alarm	<input type="text" value="Off"/>
Audio detection alarm	<input checked="" type="radio"/> On <input type="radio"/> Off
Alarm deactivation time	<input type="text" value="5"/> s (5-600s)
Camera action on alarm	
Terminal alarm 1	<input type="text" value="Off"/>
Terminal alarm 2	<input type="text" value="Off"/>
Terminal alarm 3	<input type="text" value="Off"/>
VMD alarm	<input type="text" value="Off"/>
Audio detection alarm	<input type="text" value="Off"/>
<input type="button" value="Next"/> <input type="button" value="Back"/>	

## Alarm

### [Terminal 1]

Determine how to use terminal 1.

- **Off:** Not used.
- **Alarm input(TRM1):** Receives terminal alarm input.
  - **Close:** An alarm is detected when the terminal status is changed to “On”.
  - **Open:** An alarm is detected when the terminal status is changed to “Off”.
- **Black & white input:** Receives the black & white input. (When the input is set to “On”, the black & white mode is activated)
- **Auto time adjustment:** Receives time setting through terminal input. When the signal is entered, if the time difference from the hour (every hour) is less than 29 minutes, the time is adjusted to 00 minutes 00 seconds. The time is not changed in operations which reset the time under 5 seconds. If you select auto time adjustment, the pull-down menu to select close or open is displayed.
  - **Close:** Performs auto time adjustment when the terminal status is changed to “Close”.
  - **Open:** Performs auto time adjustment when the terminal status is changed to “Open”.
- **Default:** Off

### [Terminal 2]

Determine how to use terminal 2.

- **Off:** Not used.
- **Alarm input(TRM2):** Receives terminal alarm input.
  - **Close:** An alarm is detected when the terminal status is changed to “On”.
  - **Open:** An alarm is detected when the terminal status is changed to “Off”.
- **Alarm output:** Alarm output will be carried out according to the settings for “Output terminal” (→page 154).



- **Default:** Off

### [Terminal 3]

Determine how to use terminal 3.

- **Off:** Not used.
- **Alarm input(TRM3):** Receives terminal alarm input.
  - **Close:** An alarm is detected when the terminal status is changed to “On”.
  - **Open:** An alarm is detected when the terminal status is changed to “Off”.
- **AUX output:** AUX output is carried out. The [AUX] button will be displayed on the “Live” page.
- **Default:** Off

### [VMD alarm]

Select an auto track alarm to be used from the following.

- **On:** If the VMD area is not configured, the entire region is configured. To configure the VMD area, use the [VMD area] tab on the “Alarm” page. (→page 168)
- **Off:** Disables all VMD states.
- **Default:** Off

### [Auto track alarm]

Select an auto track alarm to be used from the following.

- **Off:** Not used.
- **On(Immediate):** Alarms are continuously outputted during auto tracking. (Outputs are made at 5 second intervals.)
- **On(After alarm wait time):** Alarms are outputted only once when the auto tracking is continuously performed for a set period.
- **On(In preset alarm area):** While tacking, if the tracking target enters the set alarm area, an alarm is outputted once.
- **Default:** Off

#### Note

- When “On(After alarm wait time)” is selected, it is required to set “Alarm wait time” in the auto track setting. (→Page 131)

### [Audio detection alarm]

- **On:** If audio detection is not configured, set audio detection to “On”. To set the sensitivity of audio detection, set using the [Audio detection] tab on the “Alarm” page. (→page 170)
- **Off:** Disables audio detection.
- **Default:** Off

### [Alarm deactivation time]

Set the duration for which detection is not to be performed after an alarm has been detected. For example, by using this function you can prevent mail from being sent too often when the E-mail notifications are configured to be sent to cellular phones when an alarm is detected.

5 – 600 seconds

- **Default:** 5s

#### Note

- The duration of the alarm deactivation time can be specified for each type of alarm. For example, during the time when detections for “Terminal alarm 1” are not made, detections for “VMD alarm” can be made.

### Camera action on alarm

#### [Terminal alarm 1]

Select an action to be taken when a terminal alarm 1 is detected from the following.

This setting is available when "Terminal 1" is selected for "Alarm input(TRM1)" of the [Alarm] tab.

- **Off:** Does not take any action even when a terminal alarm 1 is detected.
- **1-256:** If a previously registered preset position is selected, when a terminal alarm 1 is detected, the camera will move to that position.
- **Auto track:** When a terminal alarm 1 is detected, the camera will start the auto tracking.
- **Patrol 1:** When a terminal alarm 1 is detected, the camera will start the patrol.  
\* If "Patrol 1" is not registered, it is not displayed on the screen.
- **Default:** Off

#### [Terminal alarm 2]

Select an action to be taken when a terminal alarm 2 is detected from the following.

This setting is available when "Terminal 2" is selected for "Alarm input(TRM2)" of the [Alarm] tab.

- **Off:** Does not take any action even when a terminal alarm 2 is detected.
- **1-256:** If a previously registered preset position is selected, when a terminal alarm 2 is detected, the camera will move to that position.
- **Auto track:** When a terminal alarm 2 is detected, the camera will start the auto tracking.
- **Patrol 2:** When a terminal alarm 2 is detected, the camera will start the patrol.  
\* If "Patrol 2" is not registered, it is not displayed on the screen.
- **Default:** Off

#### [Terminal alarm 3]

Select an action to be taken when a terminal alarm 3 is detected from the following.

This setting is available when "Terminal 3" is selected for "Alarm input(TRM3)" of the [Alarm] tab.

- **Off:** Does not take any action even when a terminal alarm 3 is detected.
- **1-256:** If a previously registered preset position is selected, when a terminal alarm 3 is detected, the camera will move to that position.
- **Auto track:** When a terminal alarm 3 is detected, the camera will start the auto tracking.
- **Patrol 3:** When a terminal alarm 3 is detected, the camera will start the patrol.  
\* If "Patrol 3" is not registered, it is not displayed on the screen.
- **Default:** Off

#### [VMD alarm]

Select an action to be taken when a VMD alarm is detected from the following.

- **Off:** Does not take any action even when a VMD alarm is detected.
- **1-256:** If a previously registered preset position is selected, when a VMD alarm is detected, the camera will move to that position.
- **Auto track:** When a VMD alarm is detected, the camera will start the auto tracking.
- **Patrol 1:** When a VMD alarm is detected, the camera will start the patrol.  
\* If "Patrol 1" is not registered, it is not displayed on the screen.
- **Default:** Off

#### [Audio detection alarm]

Select an action to be taken when a sound alarm is detected from the following.

- **Off:** Does not take any action even when a sound alarm is detected.
- **1-256:** If a previously registered preset position is selected, when a sound alarm is detected, the camera will move to that position.
- **Auto track:** When a sound alarm is detected, the camera will start the auto tracking.
- **Patrol 1:** When a sound alarm is detected, the camera will start the patrol.  
\* If "Patrol 1" is not registered, it is not displayed on the screen.

- **Default:** Off

#### [Next] button

If you click the [Next] button, the alarm function type setup menu will be displayed. (→page 59)

#### Note

- If you click the [Next] button, the setting items in the screen are saved.

#### [Back] button

If you click the [Back] button, the event function type setup menu will be displayed. (→page 55)

### 2.3.2.3 Alarm: Configure the alarm function type (Alarm function type setup menu)

Select the alarm function type as “FTP img. trans.” or “SD memory recording”.

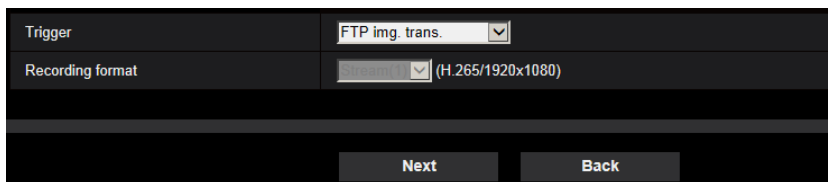

#### [Trigger]

- **FTP img. trans.:** When an alarm occurs, performs FTP transfer of the JPEG image.
- **SD memory recording:** When an alarm occurs, records the image to the SD memory card.

#### Note

- “FTP img. trans.” for when an alarm occurs and “FTP periodic image transmission” can both be performed simultaneously.
- If both “FTP img. trans.” for when an alarm occurs and “FTP periodic image transmission” are set, “FTP img. trans.” will be given priority when an alarm occurs.

#### [Recording format]

When “SD memory recording” is selected for “Trigger”, “JPEG(1)”, “JPEG(2)”, “JPEG(3)”, “Stream(1)”, “Stream(2)”, “Stream(3)”, or “Stream(4)” can be selected for the stream encoding format for the recorded image.

#### [Next] button

If you select “FTP img. trans.” for “Trigger” and click the [Next] button, the FTP transfer setup menu will be displayed. (→page 60)

If you select “SD memory recording” for “Trigger”, select “JPEG(1)”, “JPEG(2)”, or “JPEG(3)” for “Recording format”, and then click the [Next] button, the JPEG recording setup menu will be displayed. (→page 61)

If you select “SD memory recording” for “Trigger”, select “Stream(1)”, “Stream(2)”, “Stream(3)”, or “Stream(4)” for “Recording format”, and then click the [Next] button, the video recording setup menu will be displayed. (page 61)

#### Note

- If you click the [Next] button, the setting items in the screen are saved.

#### [Back] button

If you click the [Back] button the alarm setup menu will be displayed. (→page 56)

### 2.3.2.4 Alarm: Configure the details for image transfer or recording conditions

#### ① Set FTP transfer (FTP transfer setup menu)

FTP transfer when an alarm is detected is set in this section.

FTP	
Alarm image FTP transmission	<input checked="" type="radio"/> On <input type="radio"/> Off
Directory name	<input type="text"/>
File name	<input checked="" type="checkbox"/> Terminal 1 <input checked="" type="checkbox"/> Terminal 2 <input checked="" type="checkbox"/> Terminal 3 <input checked="" type="checkbox"/> VMD <input checked="" type="checkbox"/> Audio detection <input checked="" type="checkbox"/> Auto track
FTP transmission retry	<input type="radio"/> On <input checked="" type="radio"/> Off
Pre alarm	Transmission interval: <input type="text"/> fms Maximum number of images: <input type="text"/> pics Recording duration: 0s
Post alarm	Transmission interval: <input type="text"/> fms Number of images: <input type="text"/> pics Recording duration: 100s
Image capture size	<input type="text"/> JPEG (640x360)
Image compression rate upon alarm detection	<input type="radio"/> On <input checked="" type="radio"/> Off
Image quality upon alarm detection	<input type="text"/> 5 Normal
FTP server address	<input type="text"/> Example of entry: 192.168.0.10
User name	<input type="text"/>
Password	<input type="text"/>
Control port	<input type="text"/> 21 (1-65535)
FTP mode	<input type="radio"/> Passive <input checked="" type="radio"/> Active

Refer to page 196 for information about how to set the above screen. For information about “Image compression rate upon alarm detection” and “Image quality upon alarm detection”, refer to “2.7.4.2 Configure settings relating to image quality on alarm action”.

#### [Next] button

If you select “Alarm output” in the alarm setup menu and click the [Next] button, the alarm output setup menu will be displayed. (→page 62)

If you click the [Next] button in the alarm setup menu without selecting “Alarm output”, the mail setup menu will be displayed. (→page 63)

#### Note

- If you click the [Next] button, the setting items in the screen are saved.

#### [Back] button

If you click the [Back] button, the alarm function type setup menu will be displayed. (→page 59)

## ② Configure SD memory recording (JPEG) (JPEG recording setup menu)

The SD memory recording (JPEG) when an alarm is detected is configure in this section.

JPEG recording(Alarm)		
File name	<input type="text" value="img_"/>	
Image saving interval/Number of images to be saved(Pre alarm)	Image saving interval	Number of images to be saved
	1fps	Off
Image saving interval/Number of images to be saved(Post alarm)	Image saving interval	Number of images to be saved
	1fps	100 pics
<input type="button" value="Next"/> <input type="button" value="Back"/>		

Refer to page 82 of 2.4.2 Configure the settings relating to the SD memory card [SD memory card] for information about how to set the above screen.

### [Next] button

If you select “Alarm output” in the alarm setup menu and click the [Next] button, the alarm output setup menu will be displayed. (→page 62)

If you click the [Next] button in the alarm setup menu without selecting “Alarm output”, the mail setup menu will be displayed. (→page 63)

### [Back] button

If you click the [Back] button, the alarm function type setup menu will be displayed. (→page 59)

## ③ Configure SD memory recording (H.265 or H.264) (video recording setup menu)

The SD memory recording (H.265 or H.264) when an alarm is detected is configured in this section.

Stream recording(Alarm)	
Audio recording	<input checked="" type="radio"/> On <input type="radio"/> Off
Frame rate*	30fps *
Pre alarm (recording) duration	Off
Post alarm (recording) duration	30s
<input type="button" value="Next"/> <input type="button" value="Back"/>	

### [Audio recording]

Select On/Off to determine whether or not to record audio data.

- **On:** Saves audio data to videos (MP4 format).
- **Off:** Does not save audio data to videos (MP4 format).

### Note

- This setting is not available when “Interactive(Half-duplex)” is selected for “Audio transmission mode”.

### [Frame rate]

Select a frame rate for the H.265 (or H.264) to be recorded.

**Note**

- Refer to [Frame rate\*] in “2.3.2.8 Schedule: Set SD memory recording (video recording setup menu)” for information about available frame rates and the bit rates that are set according to the frame rate.

**[Pre alarm (recording) duration]**

Determine whether or not to perform the pre alarm recording. Set the duration to save image data on the SD memory card.

Off/ 1s/ 2s/ 3s/ 4s/ 5s/ 8s/ 10s/ 15s/ 20s/ 25s/ 30s/ 40s/ 50s/ 60s

- **Default:** Off

**Note**

- The values change depending on the bit rate and the image capture size of the recorded stream. As the selected bit rate increases, the available maximum value for the pre alarm duration decreases.

**[Post alarm (recording) duration]**

Set the duration to save image data on the SD memory card after an alarm occurrence.

10s/ 20s/ 30s/ 40s/ 50s/ 60s/ 120s/ 180s/ 240s/ 300s

- **Default:** 30s

\* The actual recording time may sometimes be longer than the duration selected for this setting.

**[Next] button**

If you select “Alarm output” in the alarm setup menu and click the [Next] button, the alarm output setup menu will be displayed. (→page 62)

If you click the [Next] button in the alarm setup menu without selecting “Alarm output”, the mail setup menu will be displayed. (→page 63)

**Note**

- If you click the [Next] button, the setting items in the screen are saved.

**[Back] button**

If you click the [Back] button, the alarm function type setup menu will be displayed. (→page 59)

### 2.3.2.5 Alarm: Configure the output terminal

Alarm output is configured in this section. This screen will be displayed when “Alarm output” is selected in the alarm setup menu.

- To configure settings relating to the output terminal:

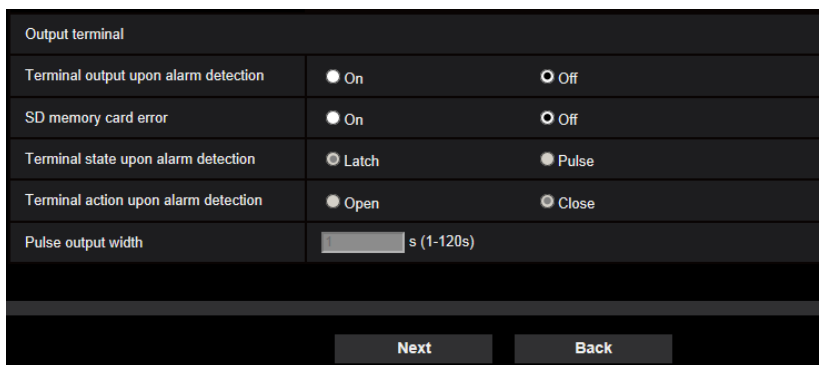

Refer to page 154 for information about how to configure the above screen.

**[Next] button**

If you click the [Next] button, the mail setup menu will be displayed. (→page 63)

**Note**

- If you click the [Next] button, the setting items in the screen are saved.

**[Back] button**

If you click the [Back] button, either the FTP transfer setup menu (→page 60), the JPEG recording setup menu (→page 61), or the video recording setup menu (→page 61) will be displayed.

### 2.3.2.6 Alarm: configure the mail notifications and mail server

The settings relating to e-mail can be configured in this section.

## 2 Settings

- To configure e-mail related settings:

E-mail notification	
E-mail notification	<input type="radio"/> On <input type="radio"/> Off
Alarm image attachment	<input type="radio"/> On <input type="radio"/> Off
Image capture size	<input type="text" value=""/> (640x360)
SMTP server address	<input type="text" value=""/> Example of entry: 192.168.0.10
SMTP port	<input type="text" value="25"/> (1-65535)
POP server address	<input type="text" value=""/> Example of entry: 192.168.0.10
Authentication	Type <input type="radio"/> None <input type="radio"/> POP before SMTP <input type="radio"/> SMTP
	User name <input type="text" value=""/>
	Password <input type="text" value=""/>
Sender's E-mail address	<input type="text" value=""/>
SSL	<input type="radio"/> On <input type="radio"/> Off
Destination of notification	Destination E-mail address
Address 1	<input type="text" value=""/> <input type="button" value="Delete"/>
	<input type="checkbox"/> Terminal 1 <input type="checkbox"/> Terminal 2 <input type="checkbox"/> Terminal 3 <input type="checkbox"/> VMD <input type="checkbox"/> Audio detection <input type="checkbox"/> Auto track
Address 2	<input type="text" value=""/> <input type="button" value="Delete"/>
	<input type="checkbox"/> Terminal 1 <input type="checkbox"/> Terminal 2 <input type="checkbox"/> Terminal 3 <input type="checkbox"/> VMD <input type="checkbox"/> Audio detection <input type="checkbox"/> Auto track
Address 3	<input type="text" value=""/> <input type="button" value="Delete"/>
	<input type="checkbox"/> Terminal 1 <input type="checkbox"/> Terminal 2 <input type="checkbox"/> Terminal 3 <input type="checkbox"/> VMD <input type="checkbox"/> Audio detection <input type="checkbox"/> Auto track
Address 4	<input type="text" value=""/> <input type="button" value="Delete"/>
	<input type="checkbox"/> Terminal 1 <input type="checkbox"/> Terminal 2 <input type="checkbox"/> Terminal 3 <input type="checkbox"/> VMD <input type="checkbox"/> Audio detection <input type="checkbox"/> Auto track
E-mail subject	<input type="checkbox"/> Use the camera title <input type="checkbox"/> Cause of alarm <input type="text" value=""/>
E-mail body	<input checked="" type="checkbox"/> Cause of alarm <input checked="" type="checkbox"/> Occurrence time
	<input type="text" value="The %p% alarm was occurred at %t%"/>
<input type="button" value="Set"/> <input type="button" value="Back"/>	

Refer to page 191 for information about how to configure the above screen.

### [Set] button

If you click the [Set] button, setup will be completed.

### [Back] button

If you click the [Back] button, either the FTP transfer setup menu (→page 60), the JPEG recording setup menu (→page 61), the video recording setup menu (→page 61), or the alarm output setup menu (→page 62) will be displayed.



### 2.3.2.7 Schedule: Configure SD recording or FTP periodic image transmission (schedule function type setup menu)

Here, the schedule type is selected as “SD memory recording” or “FTP periodic image transmission”.

Trigger	SD memory recording ▼
Recording format	Stream(1) ▼ (H.265/1920x1080)
<input type="button" value="Next"/> <input type="button" value="Back"/>	

#### [Trigger]

- **SD memory recording:** Records the H.265 (or H.264) image in the SD memory card at the scheduled time.
- **FTP periodic image transmission:** Transmits the JPEG image to the FTP server at the scheduled time.

#### [Recording format]

When “SD memory recording” is selected for “Trigger”, “Stream(1)”, “Stream(2)”, “Stream(3)”, or “Stream(4)” can be selected for the recorded image.

#### [Next] button

If you select “SD memory recording” and click the [Next] button, the video recording setup menu will be displayed. (→page 65)

If you select “FTP periodic image transmission” and click the [Next] button, the FTP periodic image transmission setup menu will be displayed. (→page 67)

#### Note

- If you click the [Next] button, the setting items in the screen are saved.

#### [Back] button

If you click the [Back] button, the event function type setup menu will be displayed. (→page 55)

#### Note

- “FTP periodic image transmission” and “FTP img. trans.” for when an alarm occurs can both be performed simultaneously.
- If you select “SD memory recording”, the “FTP periodic image transmission” setting will be canceled.

### 2.3.2.8 Schedule: Set SD memory recording (video recording setup menu)

Here, SD memory recording (H.265 or H.264) is configured according to the schedule.

Stream recording	<input checked="" type="radio"/> On <input type="radio"/> Off
Audio recording	<input type="radio"/> On <input checked="" type="radio"/> Off
Frame rate*	30fps* ▼
Overwrite	<input checked="" type="radio"/> On <input type="radio"/> Off
<input type="button" value="Next"/> <input type="button" value="Back"/>	

### [Audio recording]

Determine whether or not to perform audio recording.

- **On:** Saves audio data to videos (MP4 format).
- **Off:** Does not save audio data to videos (MP4 format).
- **Default:** Off

#### **Note**

- This setting is not available when “Interactive(Half-duplex)” is selected for “Audio transmission mode”.

### **IMPORTANT**

- When the [Overwrite] setting is changed from “Off” to “On”, if the remaining capacity of the SD memory card is low, old images may be deleted in order to prepare to save new images.

### [Frame rate\*]

Select a frame rate for the H.265 or H.264 to be recorded from the following.

1fps/ 3fps/ 5fps\*/ 7.5fps\*/ 10fps\*/ 12fps\*/ 15fps\*/ 20fps\*/ 30fps\*

- **Default:** 30fps\*

#### **Note**

- If you click the [Next] button, the “Transmission priority” will be set to “Frame rate”. (→page 100)

The bit rate is set as follows depending on the selected image capture size and frame rate.

Unit: kbps

Image capture size	Frame rate (fps)								
	1	3	5	7.5	10	12	15	20	30
<b>320×180</b>	128	256	256	256	256	256	256	256	384
<b>QVGA</b>	128	256	256	256	256	256	256	256	384
<b>400×300</b>	128	256	256	256	256	384	384	384	384
<b>640×360</b>	256	384	384	384	384	384	384	384	512
<b>VGA</b>	256	384	384	384	384	384	384	384	512
<b>800×600</b>	384	512	512	512	768	768	768	768	1024
<b>1280×720</b>	384	512	512	512	768	768	768	1024	1536
<b>1280×960</b>	512	768	768	768	768	1024	1024	1024	1536
<b>1920×1080</b>	768	1024	1024	1024	1536	1536	1536	2048	2048
<b>2048×1536</b>	1024	1536	1536	1536	2048	2048	2048	2048	3072

### [Overwrite]

Determine whether or not to overwrite images when the remaining capacity of the SD memory card becomes insufficient.

- **On:** Overwrites when the remaining capacity of the SD memory card becomes insufficient. (The oldest image is the first to be overwritten.)
- **Off:** Stops saving images on the SD memory card when the SD memory card becomes full.

- **Default:** Off

### **IMPORTANT**

- When the [Overwrite] setting is changed from “Off” to “On”, if the remaining capacity of the SD memory card is low, old images may be deleted in order to prepare to save new images.

### **[Next] button**

If you click the [Next] button, the setup menu to set the schedule for recording into the SD memory card will be displayed. (→page 67)

### **[Back] button**

If you click the [Back] button, the schedule function type setup menu will be displayed. (→page 65)

- To configure the schedule settings:

Schedules	
Schedule 1 (White) <span style="color: white;">■</span>	Schedule mode VMD permission
	Time range <input checked="" type="checkbox"/> Mon <input checked="" type="checkbox"/> Tue <input checked="" type="checkbox"/> Wed <input checked="" type="checkbox"/> Thu <input checked="" type="checkbox"/> Fri <input checked="" type="checkbox"/> Sat <input checked="" type="checkbox"/> Sun 24h 09:00 - 17:30
Schedule 2 (Blue) <span style="color: blue;">■</span>	Schedule mode VMD permission
	Time range <input checked="" type="checkbox"/> Mon <input checked="" type="checkbox"/> Tue <input type="checkbox"/> Wed <input checked="" type="checkbox"/> Thu <input checked="" type="checkbox"/> Fri <input checked="" type="checkbox"/> Sat <input type="checkbox"/> Sun 24h 23:00 - 07:00
Schedule 3 (Green) <span style="color: green;">■</span>	Schedule mode FTP periodic image transmission
	Time range <input type="checkbox"/> Mon <input type="checkbox"/> Tue <input type="checkbox"/> Wed <input type="checkbox"/> Thu <input type="checkbox"/> Fri <input type="checkbox"/> Sat <input type="checkbox"/> Sun <input checked="" type="checkbox"/> 24h
Schedule 4 (Red) <span style="color: red;">■</span>	Schedule mode Off
	Time range <input type="checkbox"/> Mon <input type="checkbox"/> Tue <input type="checkbox"/> Wed <input type="checkbox"/> Thu <input type="checkbox"/> Fri <input type="checkbox"/> Sat <input type="checkbox"/> Sun <input type="checkbox"/> 24h
Schedule 5 (Black) <span style="color: black;">■</span>	Schedule mode Off
	Time range <input type="checkbox"/> Mon <input type="checkbox"/> Tue <input type="checkbox"/> Wed <input type="checkbox"/> Thu <input type="checkbox"/> Fri <input type="checkbox"/> Sat <input type="checkbox"/> Sun <input type="checkbox"/> 24h
<input type="button" value="Set"/> <input type="button" value="Back"/>	

Refer to page 232 for information about how to set the above screen.

### **[Set] button**

If you click the [Set] button, setup will be completed.

### **[Back] button**

If you click the [Back] button, the (video recording setup menu will be displayed. (→page 65)

### **Note**

- Video recording is not performed if “SD memory recording” is not selected in the “Schedule mode”.

## **2.3.2.9 Schedule: Configure FTP periodic image transmission (FTP periodic image transmission setup menu)**

The FTP periodic image transmission is configured in this section.

## 2 Settings

---

- To configure FTP periodic image transmission settings:

FTP periodic image transmission	
FTP periodic image transmission	<input type="radio"/> On <input type="radio"/> Off
Directory name	<input type="text"/>
File name	<input type="text"/> <input type="radio"/> Name w/time&date <input type="radio"/> Name w/o time&date
Transmission interval	<input type="text"/> <input type="button" value="v"/>
Image capture size	<input type="text"/> (640x360)
FTP server address	<input type="text"/> Example of entry: 192.168.0.10
User name	<input type="text"/>
Password	<input type="text"/>
Control port	<input type="text"/> (1-65535)
FTP mode	<input type="radio"/> Passive <input type="radio"/> Active
<input type="button" value="Next"/> <input type="button" value="Back"/>	

Refer to page 196 for information about how to configure the above screen.

### **[Next] button**

If you click the [Next] button, the setup menu to set the FTP periodic image transmission schedule will be displayed. (→page 69)

### **Note**

- If you click the [Next] button, the setting items in the screen are saved.

### **[Back] button**

If you click the [Back] button, the schedule function type setup menu will be displayed. (→page 65)

- To configure FTP periodic image transmission schedule settings:

The screenshot displays the 'Schedule' configuration interface. It features a list of five schedules, each with a color-coded icon and a 'Schedule mode' dropdown menu set to 'Off'. Below each schedule is a 'Time range' section with checkboxes for days of the week (Mon-Sun) and a '24h' section with time selection dropdowns. At the bottom, there is a weekly grid with time slots from 0:00 to 24:00 for each day (Mon-Sun). A 'Set' button is located at the bottom center of the screen.

Refer to page 232 for information about how to set the above screen.

### **[Set] button**

If you click the [Set] button, setup will be completed.

### **[Back] button**

If you click the [Back] button, the FTP periodic image transmission setup menu will be displayed.  
(→page 67)

## 2 Settings

---

### **Note**

- FTP periodic image transmission will not be performed when “FTP periodic image transmission” is not selected in “Schedule mode”.

## 2.4 Configure the basic settings of the camera [Basic]

The basic settings such as camera title, time and date, SD memory card and the logs can be configured on the “Basic” page. The “Basic” page has the [Basic] tab, the [SD memory card] tab, and the [Log] tab.

### 2.4.1 Configure the basic settings [Basic]

Click the [Basic] tab on the “Basic” page. (→For menu display and how to operate, refer to page 47, page 48)  
The settings such as the camera title, time and date, etc. can be configured on this page.

Basic		SD memory card	Log
Menu language		Auto	
Camera title		WV-X6531	
Time & date	Date/time	Feb	16
	Date/time display	<input checked="" type="radio"/> On <input type="radio"/> Off	
	Time display format	24h	
	Date/time display format	Mmm/DD/YYYY	
	Date/time position	Upper left	
	NTP	NTP >>	
	Time zone	(GMT+09:00) Osaka, Sapporo, Tokyo	
	Summer time (daylight saving)	Out	
	Start time & date	Month	Day
	End time & date	Month	Day
Camera title on screen display		<input checked="" type="radio"/> On <input type="radio"/> Off	
Camera title on screen			
Camera title position		Upper left	
OSD	Character size	100%	
Brightness status display		<input checked="" type="radio"/> On <input type="radio"/> Off	
Stabilizer		<input checked="" type="radio"/> On <input type="radio"/> Off	
Indicator		On	
Status update mode		<input checked="" type="radio"/> Polling(30s) <input type="radio"/> Real time	
Status reception port		31004 (1-65535)	
Viewer software (nvcv4Ssetup.exe)	Automatic installation	<input type="radio"/> On <input checked="" type="radio"/> Off	
	Smoother live video display on the browser (buffering)	<input checked="" type="radio"/> On <input type="radio"/> Off	
	Contrast enhancement (RGB:0 to 255)	<input checked="" type="radio"/> On <input type="radio"/> Off	
Audio out		<input type="radio"/> Audio <input checked="" type="radio"/> Monitor	
Monitor out		<input type="radio"/> NTSC <input checked="" type="radio"/> PAL	
Set			

#### [Menu language]

Select the language to initially display when the camera is accessed from the following.  
Auto/English/Japanese/Italian/French/German/Spanish/Chinese/Russian/Portuguese

- **Auto:** The language used by the browser is automatically selected. If the language used by the browser is not supported by the camera, English is selected.
- **Default:** Auto

The language displayed on the “Live” page can also be changed. (→page 12)

### **Note**

- When Japanese is selected, diagnostic e-mails and the screens in cellular phones are displayed in Japanese.  
When Chinese is selected, the screens in cellular phones are displayed in Chinese.  
When any other language is selected, diagnostic e-mails and the screens in cellular phones are displayed in English.

### **[Camera title]**

Enter the title of the camera. Click the [Set] button after entering the title of the camera. The entered title will be displayed in the “Camera title” field.

- **Available number of characters:** 0 - 20 characters
- **Unavailable characters:** " &
- **Default:** The model No. is displayed.

### **[Date/time]**

Enter the current time and date. When “12h” is selected for “Time display format”, “AM” or “PM” can be selected.

- **Available range:** Jan/01/2013 00:00:00 - Dec/31/2035 23:59:59

### **IMPORTANT**

- Use an NTP server when the more accurate time & date setting is required for the system operation. (→page 200)

### **[Date/time display]**

Select On/Off to determine whether or not to display the date and time on an image. To hide the date and time, select “Off”.

- **Default:** On

### **[Time display format]**

Select the time display format from “24h” and “12h”. Enter the current hour reflecting this setting when entering the current time and date for “Date/time”.

- **Default:** 24h

### **[Date/time display format]**

Select a date/time display format. When “2016/04/01 13:10:00” is set for “Date/time” after selecting “24h” for “Time display format”, time & date will be respectively displayed as follows.

- **DD/MM/YYYY:** 01/04/2016 13:10:00
- **MM/DD/YYYY:** 04/01/2016 13:10:00
- **DD/Mmm/YYYY:** 01/Apr/2016 13:10:00
- **YYYY/MM/DD:** 2016/04/01 13:10:00
- **Mmm/DD/YYYY:** Apr/01/2016 13:10:00
- **Default:** Mmm/DD/YYYY

### **[Date/time position]**

Select the position to display the time and date in an image.

- **Upper left:** The information will be displayed at the upper left corner of the screen.
- **Lower left:** The information will be displayed at the lower left corner of the screen.
- **Upper center:** The information will be displayed at the upper center of the screen.
- **Lower center:** The information will be displayed at the lower center of the screen.



- **Upper right:** The information will be displayed at the upper right corner of the screen.
- **Lower right:** The information will be displayed at the lower right corner of the screen.
- **Default:** Upper left

### [NTP]

When “NTP >>” is clicked, the [Advanced] tab of the “Network” page will be displayed. (→page 200)

### [Time zone]

Select a time zone corresponding to the location where the camera is in use.

- **Default:** (GMT +09:00) Osaka, Sapporo, Tokyo

### [Summer time (daylight saving)]

Select “In”, “Out” or “Auto” to determine whether or not to apply daylight saving time. Configure this setting if the summer time (daylight saving time) is applied in the location where the camera is in use.

- **In:** Applies summer time. An asterisk (\*) will be displayed on the left side of the displayed time and date.
- **Out:** Does not apply summer time.
- **Auto:** Applies summer time in accordance with the settings for “Start time & date” and “End time & date” (month, week, day of the week, time).
- **Default:** Out

### [Start time & date] [End time & date]

When “Auto” is selected for “Summer time (daylight saving)”, select the time & date for the start time and the end time (month, week, day of the week, time).

### [Camera title on screen display]

Select “On” or “Off” to determine whether or not to display the camera title on the screen. When “On” is selected, the character string entered for “Camera title on screen” will be displayed at the position selected for “Camera title position”.

- **Default:** Off

### [Camera title on screen]

Enter a character string to be displayed on the image.

- **Available number of characters:** 0 - 20 characters
- **Available characters:** 0-9, A-Z, a-z and the following marks.  
! " # \$ % & ' ( ) \* + , - . / : ; = ?
- **Default:** None (blank)

### [Camera title position]

Select the position where the character string is displayed on the screen.

- **Upper left:** The character string will be displayed in the upper left part of the screen.
- **Lower left:** The character string will be displayed in the lower left part of the screen.
- **Upper center:** The character string will be displayed in the upper center part of the screen.
- **Lower center:** The character string will be displayed in the lower center part of the screen.
- **Upper right:** The character string will be displayed in the upper right part of the screen.
- **Lower right:** The character string will be displayed in the lower right part of the screen.
- **Default:** Upper left

### [OSD] - [Character size]

Select the character size of the date and time as well as text displayed in the image.

- **100%:** Displays in the standard size.
- **150%:** Displays in 150% of the standard size.
- **200%:** Displays in 200% of the standard size.

- **Default:** 100%

### **IMPORTANT**

- If the settings for [Date/time position] and [Camera title position] are different, the frame rate may be lower than the specified value.
- If the settings for [Date/time position] and [Camera title position] are different, characters may be displayed incorrectly or overlapped depending on the [Character size] setting and the number of characters used. After completing the settings, confirm the result on the “Live” page.
- If “150%” or “200%” is selected for [Character size], the frame rate may be lower than the specified value.
- Depending on the setting and the numbers of characters used for [Character size] and the image capture size, characters displayed on the screen may be cut off. After completing the settings, confirm the result on the “Live” page.

### **[Brightness status display]**

Select “On” or “Off” to determine whether or not to display the status of brightness on images displayed on the “Live” page when adjusting brightness.

- **Default:** On

### **[Stabilizer]**

Select “On” or “Off” to determine whether or not to activate the image stabilizer.

Intelligent Zoom Stabilization using a gyro sensor and image vector detection enables correcting low-frequency vibration of the poles caused by wind or fine vibration generated when high magnification is set, and shooting with less blurring can be achieved. **X6531** **X6511**

This is not available when “2 mega pixel [16:9](60fps mode)” or “1.3 mega pixel [16:9](60fps mode)” is selected for “Image capture mode”.

- **Default:** Off

Only use the stabilizer function if the camera is installed in an environment that is subject to frequent vibrations. The stabilizer function can reduce the shaking in images.

Use this function after checking operations when installing the camera.

Do not use the stabilizer function if the camera is installed in an environment that is not subject to vibrations. If the stabilizer function is used in such a case and there is a moving subject, the stabilizer function will correct the image and this may cause it to appear as if the entire screen is shaking.

### **IMPORTANT**

- If “On” is selected for “Stabilizer”, the view angle will become narrower. When “On” is selected, check the view angle at camera installation.
- If “On” is selected for “Stabilizer”, the noise in images may be increased.
- If “On” is selected for “Stabilizer”, “Stream(3)” and “Stream(4)” become “Off”.
- If “On” is selected for “Stabilizer”, “Smart Facial Coding” of “Smart Coding” for “Stream(1)” becomes “Off”.
- The stabilizer is not available under the following conditions:
  - In the auto mode (auto track)
  - In the auto mode (auto pan, preset sequence, patrol) **S6530** **S6130**
  - During pan, tilt, zoom operations **S6530** **S6130**
  - During position refresh
- Depending on the photographic conditions such as in the following situations, images may not be able to be effectively stabilized.
  - When subjects are dark
  - Subjects with short-cycled image shaking, such as mechanical vibration
  - Subjects with large-amplitude image shaking
  - When subjects have little contrast, such as walls with a single color **S6530** **S6130**

- Auto mode (Auto pan, Preset sequence, Patrol) **X6531** **X6511** **S6131** **S6111**
- VMD alarm setting
- Image/Position setting
- During pan/tilt operation **X6531** **X6511** **S6131** **S6111**
- When capturing images of large subjects that are moving, stabilization may malfunction.
- If the settings for “Stabilizer” are changed when the following area settings are configured, the positions of the configured areas may move out of alignment. Configure each area after configuring “Stabilizer” settings.
  - mask area
  - privacy zone
  - VMD area
  - VIQS area
- If “On” is selected for “Stabilizer”, the privacy zone may move out of alignment when the stabilizer is operating. If you will use privacy zone, we recommend not using “Stabilizer”.

**Note**

- If there is shaking in dark environments, image stabilization can become more effective by using a high-speed shutter setting of “Max. 1/100s” or more for “Maximum shutter”. Configure “Maximum shutter” according to the installation environment.
- When the camera is used in environments of 40°C or higher, the effectiveness of the stabilizer will be reduced.

**[Indicator]**

Determine whether or not to use the following status indicators.

- **On:** The status indicator will light in accordance with the status.
- **On(Access):** The status indicator will light when images are viewed.
- **Off:** The status indicator are turned off.
- **Default:** On

**Note**

- Depending on the model, “Live indicator” will be displayed instead of “Status indicator”.  
**X6531** **X6511** **S6530**: Live indicator  
**S6131** **S6111** **S6130**: Status indicator
- **STATUS indicator (red/orange/green):** The status indicator will light or blink as follows depending on the camera status.

Operation status		Indicator status
When the power is turned on	Before the network connection is established	Lights orange → Lights off → Blinks orange → Lights orange
	When the network connection is established	Lights orange → Lights off → Blinks orange → Blinks green → Lights green
During standby or connection (Cable is not connected.)		Lights orange
During standby or connection (Cable is connected.)		Lights green
During the upgrade process		Blinks orange
During the initialization (When the network connection is established)		Lights orange → Lights off → Blinks orange → Lights orange → Blinks orange → Blinks green → Lights green

Operation status	Indicator status
Port forwarding error caused by the UPnP function	Blinks orange (in 2 seconds intervals (on for 1 second / off for 1 second))
Trouble happening on the camera	Blinks red
Failure in writing data on the SD memory card	Lights red

- When the power is turned on, the indicator may start from blinking in orange due to initialization.

### [Status update mode]

Select an interval of the camera status notification from the following.

When the status of the camera changes, the alarm occurrence indication button, [AUX] button, or the SD saving status indicator will be displayed in the “Live” page to notify of the camera status.

- **Polling(30s):** Updates the status each 30 seconds and provide notification of the camera status.
- **Real time:** Provide notification of the camera status when the status has changed.
- **Default:** Real time

### Note

- Depending on the network environment, notification may not be provided in real time.
- When multiple cameras are using the same “Status reception port”, even if “Real time” is selected for “Status update mode”, status notification is not provided in real time. In this case, change the “Status reception port” settings.

### [Status reception port]

When selecting “Real time” for “Status update mode”, designate a port number to which the status change notification is to be sent.

- **Available port number:** 1 - 65535
- **Default:** 31004

The following port numbers are unavailable since they are already in use.

20, 21, 23, 25, 42, 53, 67, 68, 69, 80, 110, 123, 161, 162, 443, 995, 10669, 10670

### [Viewer software (nwcV4Ssetup.exe)] - [Automatic installation]

Determine whether or not to install the viewer software from this camera.

- **On:** Installs the viewer software from the camera automatically.
- **Off:** The viewer software cannot be installed from the camera.
- **Default:** On

### IMPORTANT

- For PCs that do not have the viewer software “Network Camera View 4S” installed, JPEG images are displayed. You cannot display images using H.265 (or H.264) or send/receive audio to/from the camera. In order to display H.265 (or H.264) images or send/receive audio to/from the camera, you must click “Viewer Software” on the “Live” page (→page 12) and then install the viewer software.
- The number of the viewer software installations can be checked on the [Upgrade] tab of the “Maintenance” page.

### [Viewer software (nwcV4Ssetup.exe)] - [Smoother live video display on the browser (buffering)]

Perform settings to display camera images on the viewer software.

- **On:** Images are temporarily stored on the computer and are displayed smoother.
- **Off:** Images are displayed in real-time and are not stored on the computer.
- **Default:** Off

**Note**

- During the auto pan operation or when shooting the frequently moving subjects, the images may not be displayed smoothly. In such a case, enable this function by selecting "On". It should provide smoother image.

**[Viewer software (nwcv4Ssetup.exe)] - [Contrast enhancement(0 to 255)]**

Select "On" or "Off" to determine whether or not to enhance the contrast of H.265 images or H.264 images on the "Live" page.

If "On" is selected, the range of RGB signal on display is extended from 16-235 to 0-255.

When there is a bright part in an image, the intensity may be overexposed. Select a setting suitable to your usage environment.

- **Default:** Off

**Note**

- This setting is only available when viewing images on the "Live" page with Internet Explorer.
- Even if this setting is changed, transmitted image data and data saved on the SD memory card are not changed.

**[Audio out] X6531 X6511 S6131 S6111 S6530**

Set the Audio/Monitor output format.

Audio/Monitor

- **Default:** Audio

**Note**

- When "Audio out" is set to "Audio", "Monitor out" cannot be selected.
- When "Audio transmission mode" is set to anything other than "Off" or "Mic input", "Audio out" cannot be set to "Monitor".
- When "Audio out" is set to "Monitor", "Audio transmission mode" can only be set to "Off" or "Mic input".

**[Monitor out]**

Set the image format to be output to a monitor used for confirmation.

NTSC/PAL

- **Default:** NTSC

## 2.4.2 Configure the settings relating to the SD memory card [SD memory card]

Click the [SD memory card] tab on the “Basic” page. (→For menu display and how to operate, refer to page 47, page 48)

The settings relating to the SD memory card can be configured on this page.

The screenshot shows the 'SD memory card' settings page. At the top, there are three tabs: 'Basic', 'SD memory card' (which is selected), and 'Log'. The settings are organized into several sections:

- Operating mode:** Includes 'SD memory card' (radio buttons for 'Use' and 'Not use'), 'Audio recording' (radio buttons for 'On' and 'Off'), 'Remaining capacity notification' (dropdown menu set to '50%'), and 'Overwrite' (radio buttons for 'On' and 'Off').
- SD memory card security:** Includes 'Additional info for detecting alteration' with a 'Setup >>' button.
- Recording stream 1:** Includes 'Recording format' (dropdown menu set to 'JPEG(2) (640x360)'), 'Save trigger' (checkboxes for Terminal 1, Terminal 2, Terminal 3, VMD, Command alarm, Audio detection, and Auto track).
- Recording stream 2:** Includes 'Recording format' (dropdown menu set to 'Off'), 'Save trigger' (checkboxes for Terminal 1, Terminal 2, Terminal 3, VMD, Command alarm, Audio detection, and Auto track).
- SD memory card information:** Includes 'Remaining capacity' (displaying '22334MB/22420MB(Remaining capacity/Original capacity)'), 'Format' (with an 'Execute' button), and 'SD memory card images' (with an 'Access img.' label and an 'Execute' button).

At the bottom of the page, there is a 'Set' button.

## Operating mode

### [SD memory card]

Select “Use” or “Not use” to determine whether or not to use the SD memory card.

- **Default:** Use

### Note

- When “2 mega pixel [16:9](60fps mode)” or “1.3 mega pixel [16:9](60fps mode)” is selected for “Image capture mode”, functions related to SD memory cards are not available. “Not use” will be selected for “SD memory card”.

**[Audio recording]**

Select whether or not to save audio data when saving video data in MP4 format.

- **Off:** Does not save audio data to videos (MP4 format).
- **On:** Saves audio data to videos (MP4 format).
- **Default:** Off

**Note**

- When “Audio recording” is used, a stream setting must be selected for “Recording stream 1”, and “Off” must be selected for “Recording stream 2”.

**[Remaining capacity notification]**

When the E-mail notification function or the Panasonic alarm protocol function is used to provide notification of the remaining capacity of the SD memory card, select a level to be notified at from the following.

50%/ 20%/ 10%/ 5%/ 2%

- **Default:** 50%

**Note**

- Notification will be provided each time the remaining capacity goes below each of the specified values. For example, notification will be provided each time the remaining capacity reaches 50%, 20%, 10%, 5% and 2% when “50%” is selected. Notification may not always be made at the very moment when the remaining capacity of the SD memory card has reached each value.

**[Overwrite]**

Determine whether or not to overwrite when the remaining capacity of the SD memory card becomes insufficient.

- **On:** Overwrites when the remaining capacity of the SD memory card becomes insufficient. (The oldest image is the first to be overwritten.)
- **Off:** Stops saving images on the SD memory card when the SD memory card becomes full.
- **Default:** Off

**IMPORTANT**

- Select “Not use” when operating without an SD memory card.
- Before removing the SD memory card from the camera, it is necessary to select “Not use” first. The recorded data may be corrupted if the SD memory card is removed when “Use” is selected.
- When an SD memory card is inserted when “Use” is selected, data will be saved in accordance with the setting of “Save trigger”.
- After inserting the SD memory card, it is necessary to select “Use” to use the SD memory card.
- When the image refresh interval is short, notification/recording timing or interval may become incorrect. Notification/recording may also not be performed correctly as configured when multiple users are receiving images. In this case, set the refresh interval longer.
- There are limited times to overwrite on an SD memory card. When having a high frequency of overwriting, the lifetime of the SD memory card may become shorter.
- A lifetime of an SD memory card should be influenced by the number of the image files stored and log savings on the SD memory card. Selecting “Stream(1)”, “Stream(2)”, “Stream(3)”, or “Stream(4)” for “Recording format” can reduce the number of files that can be stored on the SD memory card.
- If the data writing speed goes down after data is repeatedly written on an SD memory card, we recommend replacing the SD memory card.
- When the setting is changed from “Off” to “On”, if the remaining capacity of the SD memory card is low, old images may be deleted in order to prepare to save new images.

### SD memory card security

#### [Additional info for detecting alteration]

Select whether or not to add information to enable detection when the data in the SD memory card is altered. Alteration detection supports video data (MP4 format) only and can be checked using exclusive software. Click the [Setup>>] button to display the setup menu that can configure the settings relating to additional info for detecting alteration. The setup menu will be displayed in a newly opened window. (→page 85)

### Recording stream 1/Recording stream 2

#### [Recording format]

Select the type of image data to be recorded on the SD memory card.

“Off” can only be selected for the “Recording format” of “Recording stream 2”.

“JPEG(1)”, “JPEG(2)”, and “JPEG(3)” can only be selected for the “Recording format” of “Recording stream 1”.

- **Off:** Does not record data.
- **JPEG(1):** Records still image data (JPEG(1)). The data is recorded in accordance with the settings of “JPEG(1)” on the [Image] tab of the “Image/Audio” page.
- **JPEG(2):** Records still image data (JPEG(2)). The data is recorded in accordance with the settings of “JPEG(2)” on the [Image] tab of the “Image/Audio” page.
- **JPEG(3):** Records still image data (JPEG(3)). The data is recorded in accordance with the settings of “JPEG(3)” on the [Image] tab of the “Image/Audio” page.
- **Stream(1):** Records video data (Stream(1)) in the MP4 video encoding format. The data is recorded in accordance with the settings of “Stream(1)” on the [Image] tab of the “Image/Audio” page.
- **Stream(2):** Records video data (Stream(2)) in the MP4 video encoding format. The data is recorded in accordance with the settings of “Stream(2)” on the [Image] tab of the “Image/Audio” page.
- **Stream(3):** Records video data (Stream(3)) in the MP4 video encoding format. The data is recorded in accordance with the settings of “Stream(3)” on the [Image] tab of the “Image/Audio” page.
- **Stream(4):** Records video data (Stream(4)) in the MP4 video encoding format. The data is recorded in accordance with the settings of “Stream(4)” on the [Image] tab of the “Image/Audio” page.
- **Default:**
  - **Recording stream 1:** JPEG(2)
  - **Recording stream 2:** Off

#### **IMPORTANT**

- If an SD memory card with an SD Speed Class other than 10 is used, 2048x1536 cannot be selected for the image capture size of JPEG images. Set the maximum combined bit rate of “Stream(1)”, “Stream(2)”, “Stream(3)”, and “Stream(4)” selected in “Recording format” to 6 Mbps.
- If an SD memory card with an SD Speed Class 10 is used, set the maximum combined bit rate of “Stream(1)”, “Stream(2)”, “Stream(3)”, and “Stream(4)” selected in “Recording format” to 12 Mbps.
- For SD memory cards with an SD Speed Class 10, use a card that supports UHS-I. (Ultra High Speed-I)
- Recording stream 2 is not available when a JPEG setting is selected for Recording stream 1.

#### **Note**

- When “Stream(1)” is selected, the settings for “Stream(1)” on the [Image] tab of the “Image/Audio” page will be changed to the settings for “Stream(1) & recording”.  
When “Stream(2)” is selected, the settings for “Stream(2)” on the [Image] tab of the “Image/Audio” page will be changed to the settings for “Stream(2) & recording”.  
When “Stream(3)” is selected, the settings for “Stream(3)” on the [Image] tab of the “Image/Audio” page will be changed to the settings for “Stream(3) & recording”.  
When “Stream(4)” is selected, the settings for “Stream(4)” on the [Image] tab of the “Image/Audio” page will be changed to the settings for “Stream(4) & recording”.



- When using the SD memory recording function of a Panasonic network disk recorder, select “JPEG(1)” for “Recording format” of “Recording stream 1”.
- When “Stream(1)”, “Stream(2)”, “Stream(3)”, or “Stream(4)” is selected for “Recording format”, the settings of the following functions may be corrected.
  - When “VBR” is selected for “Transmission priority”, “Frame rate” is set.
  - When “2s”, “3s”, “4s” or “5s” is selected for “Refresh interval”, “1s” is set.
- When “On” is selected for “Additional info for detecting alteration”, “Recording format” cannot be changed to “JPEG(1)”, “JPEG(2)”, or “JPEG(3)”.
- When “Stream(1)”, “Stream(2)”, “Stream(3)”, or “Stream(4)” is selected for “Recording format”, the name of the saved file will be given automatically.
- When “Stream(1)”, “Stream(2)”, “Stream(3)”, or “Stream(4)” is selected for “Recording format”, the number of users that can access the camera may be reduced.
- If “JPEG(1)”, “JPEG(2)”, or “JPEG(3)” is selected for the “Recording format” of “Recording stream 1”, and “Stream(1)”, “Stream(2)”, “Stream(3)”, or “Stream(4)” is selected for the “Recording format” of “Recording stream 2”, the maximum bit rate that can be selected for “Stream” is limited.
- When “On” is selected for “Audio recording”, the maximum value of the available bit rate for “Stream” will be limited.
- When “On” is selected for “Additional info for detecting alteration”, the maximum value of the available bit rate for “Stream” will be limited.

### [Save trigger]

Select a trigger to save images on the SD memory card from the following.

- **FTP periodic image transmission error:** Saves images when images have failed to transmit to the FTP server by the FTP periodic image transmission function. Available only for the “JPEG(1)”, “JPEG(2)”, or “JPEG(3)” images.
- **Alarm input:** Saves images at an alarm occurrence.
- **Manual:** Saves images manually.
- **Schedule:** Saves images in accordance with the settings for “Schedule” (→page 232). Available only for the “Stream(1)”, “Stream(2)”, “Stream(3)”, or “Stream(4)” images.
- **Default:**
  - **Recording stream 1:** FTP periodic image transmission error
  - **Recording stream 2:** Alarm input

If you have selected “Alarm input” in the [Save trigger], you can select the alarm type from the following:

- **Terminal 1:** Save the image when an alarm occurs in Terminal 1.
- **Terminal 2:** Save the image when an alarm occurs in Terminal 2.
- **Terminal 3:** Save the image when an alarm occurs in Terminal 3.
- **VMD:** Save the image when a motion detection occurs.
- **Command alarm:** Save the image when a command alarm is entered.
- **Audio detection:** Save the image when an audio detection occurs.
- **Auto track:** Save the image when an auto track alarm occurs.

### Note

- When “Stream(1)”, “Stream(2)”, “Stream(3)”, or “Stream(4)” is selected for “Recording format”, “FTP periodic image transmission error” is unavailable.
- To enable alarms to occur, alarm settings must be configured in advance on the [Alarm] tab.
- When “JPEG(1)”, “JPEG(2)”, or “JPEG(3)” is selected for “Recording format”, “Schedule” is unavailable.

## JPEG recording(Manual)

JPEG recording(Manual)	
File name	img_
Image saving interval	1fps

This setting is only available when “JPEG(1)”, “JPEG(2)”, or “JPEG(3)” is selected for “Recording format”, and “Manual” is selected for “Save trigger”.

### [File name]

Enter the file name used for the image to be saved on the SD memory card. The file name will be as follows.

- **File name:** [“Entered file name” + “Time and date (year/ month/ day/ hour/ minute/ second)”] + “Serial number”
- **Available number of characters:** 1 - 8 characters
- **Unavailable characters:** " & \* / : ; < > ? \ |

### [Image saving interval]

When “Manual” is selected for “Save trigger”, select an interval (frame rate) of saving images on the SD memory card from the following.

0.1fps/0.2fps/0.33fps/0.5fps/1fps

- **Default:** 1fps

## JPEG recording(Alarm)

JPEG recording(Alarm)		
File name	img_	
Image saving interval/Number of images to be saved(Pre alarm)	Image saving interval 1fps	Number of images to be saved Off
Image saving interval/Number of images to be saved(Post alarm)	Image saving interval 1fps	Number of images to be saved 100 pics

This setting is only available when “JPEG(1)”, “JPEG(2)”, or “JPEG(3)” is selected for “Recording format”, and “Alarm input” is selected for “Save trigger”.

### [File name]

Enter the file name used for the image to be saved on the SD memory card. The file name will be as follows.

- **File name:** [“Entered file name” + “Time and date (year/ month/ day/ hour/ minute/ second)”] + “Serial number”
- **Available number of characters:** 1 - 8 characters
- **Unavailable characters:** " & \* / : ; < > ? \ |

### [Image saving interval/Number of images to be saved(Pre alarm)] - [Image saving interval]

When “Alarm input” is selected for “Save trigger”, select a pre alarm interval (frame rate) of saving images on the SD memory card from the following.

0.1fps/0.2fps/0.33fps/0.5fps/1fps

- **Default:** 1fps

### [Image saving interval/Number of images to be saved(Pre alarm)] - [Number of images to be saved]

Select a number of pre alarm images to be saved on the SD memory card from the following.

Off/1pic/2pics/3pics/4pics/5pics

- **Default:** Off

### [Image saving interval/Number of images to be saved(Post alarm)] - [Image saving interval]

When “Alarm input” or “Manual” is selected for “Save trigger”, select an interval (frame rate) of saving images on the SD memory card from the following.

0.1fps/0.2fps/0.33fps/0.5fps/1fps

- **Default:** 1fps

### [Image saving interval/Number of images to be saved(Post alarm)] - [Number of images to be saved]

Select a number of alarm images to be saved on the SD memory card from the following.

10pics/ 20pics/ 30pics/ 50pics/ 100pics/ 200pics/ 300pics/ 500pics/ 1000pics/ 2000pics/ 3000pics

- **Default:** 100pics

## Stream recording(Alarm)

Stream recording(Alarm)	
Pre alarm (recording) duration	Off ▼
Post alarm (recording) duration	30s ▼

This setting is only available when “Stream(1)”, “Stream(2)”, “Stream(3)”, or “Stream(4)”, is selected for “Recording format” of the SD memory card, and “Alarm input” is selected for “Save trigger”.

### [Pre alarm (recording) duration]

Determine whether or not to perform the pre alarm recording. Set the duration to save image data on the SD memory card.

Off/ 1s/ 2s/ 3s/ 4s/ 5s/ 8s/ 10s/ 15s/ 20s/ 25s/ 30s/ 40s/ 50s/ 60s/ 90s/ 120s

- **Default:** Off

#### Note

- The available values change depending on the bit rate and image capture size for “Stream” selected for recording. As the selected bit rate increases, the available maximum value for the pre alarm duration decreases.

### [Post alarm (recording) duration]

Set the duration to save image data on the SD memory card after an alarm occurrence.

10s/ 20s/ 30s/ 40s/ 50s/ 60s/ 120s/ 180s/ 240s/ 300s

- **Default:** 30s

\* The actual recording time may sometimes be longer than the duration selected for this setting.

## SD memory card information

### [Remaining capacity]

Total capacity and remaining capacity of the SD memory card will be displayed.

Depending on the status of the SD memory card, the size indications will differ as follows.

Indication	Description
-----MB/-----MB	No SD memory card is inserted. Failed to obtain available capacity due to error, etc.
*****MB/*****MB	The SD memory card is unformatted, or locked (write-protected).

### Note

- When “Off” is selected for “Overwrite” and the available size of the SD memory card is “0 MB”, images will not be saved on the SD memory card. When the notification function is on, a notification will be sent to the registered addresses and destinations of the Panasonic alarm protocol when the SD memory card becomes full. (→page 161, page 172)

### [Format]

To format the SD memory card, click the [Execute] button.

### IMPORTANT

- Before formatting the SD memory card, it is necessary to select “Use” for “SD memory card” on the [SD memory card] tab of the “Basic” page (→page 78) and “Off” for “FTP periodic image transmission” on the [Advanced] tab of the “Network” page (→page 198).
- Use the SD memory card after formatting it using the [SD memory card] tab. If using the SD memory card that has not been formatted on the [SD memory card] tab, the following functions may not work correctly.
  - Save/obtain images that failed to transmit to the FTP server using the FTP periodic image transmission function
  - Save/obtain alarm images
  - Save/obtain images saved manually
  - Save/obtain images in accordance with the schedule settings
  - Save/obtain the alarm logs, the manual/schedule logs, the FTP error logs and the system logs
  - Save/obtain images recorded using the SD memory recording function of Panasonic network disk recorder
  - Play/download images on the SD memory card
- When an SD memory card is formatted while another user is in operation, the operation will be canceled.
- It is impossible to access the SD memory card during the process of formatting.
- All data saved on the SD memory card will be deleted when the SD memory card is formatted.
- Do not turn off the power of the camera during the process of formatting.
- After formatting the SD memory card, available size may be smaller than the total size since the default directory is automatically created in the SD memory card.
- Compatible SD memory card (option)  
Manufactured by Panasonic (SD speed class 4 or higher)  
miniSD and microSD cards cannot be used.
  - SDXC memory card: 64 GB, 128 GB, 256 GB
  - SDHC memory card: 4 GB, 8 GB, 16 GB, 32 GB
  - SD memory card: 2 GB
- Refer to our website (<https://security.panasonic.com/support/info/>) for latest information about the compatible SD memory cards.
- When repeatedly recording images on an SD memory card using the auto overwrite function, make sure to use an SD memory card with high reliability and durability.
- Use the SD memory card that complies with UHS-1(Ultra High Speed-1) in the case of SD Speed Class10.

## SD memory card images

### [Access img.]

Images on the SD memory card can be obtained. Click the [Execute] button. Refer to page 91 for how to access images.

## 2.4.3 Configure the settings relating to alteration detection

### [Alteration detection]

Selecting alteration detection enables detection using exclusive software when the data on the SD memory card is altered.

Alteration detection supports video files (MP4 format) only.

Refer to page 86 for information on how to configure alteration detection.

For further information about exclusive software for alteration detection and how to use it, refer to our website below.

<https://security.panasonic.com/support/info/>

#### Note

- When Alteration detection is used, a stream setting must be selected for “Recording stream 1”, and “Off” must be selected for “Recording stream 2”.

Alteration detection	
Select certificate	Pre-installed ▾
Additional info for detecting alteration	<input checked="" type="radio"/> On <input type="radio"/> Off
Set	
Pre-installed certificate	
Certificate download	Execute
CA Certificate	
CRT key generate	Execute
Generate Certificate Signing Request	Execute
CA Certificate install	<input type="text"/> Browse... Execute
Information	Invalid <input type="button" value="Confirm"/> <input type="button" value="Delete"/>
Certificate download	Execute
Close	

#### [Select certificate]

Select the certificate to be used with HTTPS.

**Pre-installed:** Selects a pre-installed certificate.

**CA:** Selects a “CA Certificate”. Only displayed when the “CA Certificate” is installed.

**Default:** Pre-installed

#### [Additional info for detecting alteration]

Select whether or not to give information for alteration detection to video files (MP4 format) to be saved on the SD memory card.

#### Note

- When the certificate (CA certificate) issued by CA (Certificate Authority) is not valid, “On” cannot be selected.

- When “JPEG(1)”, “JPEG(2)”, or “JPEG(3)” is selected for “Recording format” of “Recording stream 1”, “On” cannot be selected.

### **[Pre-installed certificate - Certificate download]**

Click the [Execute] button and download the root certificate for the pre-installed certificate. By installing the root certificate to your PC, you can get signature verification for the pre-installed certificate.

### **Note**

- Refer to the Panasonic website (<https://security.panasonic.com/support/info/>) for further information about how to install certificates on your PC.

### **[CA Certificate - CRT key generate]**

CRT key (encryption key) used for alteration detection is generated. To generate the CRT key, click the [Execute] button to display “CRT key generate” dialog box.

### **[CA Certificate - Generate Certificate Signing Request]**

When using the CA certificate issued by CA as the CA certificate used for alteration detection, the CSR (Certificate Signing Request) will be generated.

To generate the CSR, click the [Execute] button to display the “CA Certificate - Generate Certificate Signing Request” dialog window.

### **[CA Certificate - Certificate install]**

Installs the certificate (CA certificate) issued by CA and displays the information of the installed certificate (CA certificate).

To install the certificate (CA certificate), click the [Browse...] button to display the [Open] dialog box, and select the file of the certificate (CA certificate) issued by CA, and click the [Execute] button.

If the certificate (CA certificate) is already installed, the file name of the installed certificate will be displayed.

### **[CA Certificate - Information]**

Displays the information of the certificate (CA certificate) issued by CA.

When the [Confirm] button is clicked, the registered information of the installed certificate (CA certificate) will be displayed in the “CA Certificate - Confirm” dialog box. If the certificate (CA certificate) is not installed, the content of the generated CSR file will be displayed.

When the [Delete] button is clicked, the installed certificate (CA certificate) will be deleted.

### **[CA Certificate - Certificate download]**

Downloads the certificate (CA certificate) issued by CA from the camera.

When implementing alteration detection of video data (MP4 files) on the SD memory card using exclusive software, the downloaded certificate is used.

### **IMPORTANT**

- Before deleting the valid certificate (CA certificate), confirm that there is a backup file of the certificate (CA certificate) on the PC or another media. The backup file will be required when installing the certificate (CA certificate) again.

## **2.4.4 How to configure alteration detection settings**

The settings relating to alteration detection that detects when data in the SD memory card is altered or edited can be configured on this page.

The alteration detection settings will be configured in the following procedure.

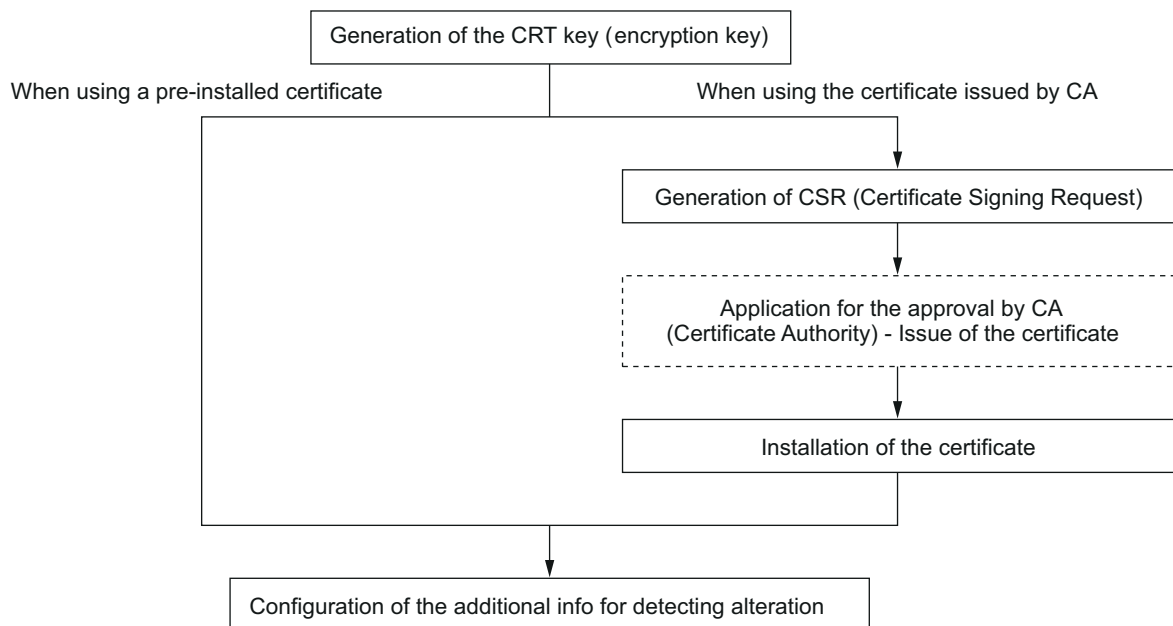

### 2.4.4.1 Generation of the CRT key (encryption key)

#### **IMPORTANT**

- When the certificate (CA certificate) issued by CA is valid, it is impossible to generate the CRT key.
- When the certificate (CA certificate) issued by CA is used, the available key size varies depending on the CA. Check the available key size in advance.
- To generate the CRT key, it may take about 2 minutes. Do not operate the web browser until the generation of CRT key is complete. While the CRT key is being generated, the refresh interval and line speed may be lower.

1. Click the [Execute] button of “CRT key generate”.  
→ The “CRT key generate” dialog box will be displayed.

Current CRT key			
CRT key	RSA key size		
	Last modified	Not generated	<b>History</b>
CRT key generate			<b>Execute</b>
*Generating a CRT key takes around 2 minutes.			
<b>Close</b>			

2. Click the [Execute] button.  
→ The generation of CRT key will be started. When the generation is finished, the key size and generation time & date of the generated key will be displayed on “Current CRT key”.

**Note**

- To change (or update) the generated CRT key, perform step 1 to 2. The CRT key and certificate issued by CA are valid in a set. When the CRT key is changed, it is necessary to re-apply for the certificate issued by CA.
- When the CRT key is updated, the log of the previous CRT key is saved. When the [History] button of “Current CRT key” on the “CRT key generate” dialog box is clicked, the “Previous CRT key” dialog box will be displayed, and it is possible to check the key size and generation time & date of the previous key. When the [Apply] button is clicked on the “Previous CRT key” dialog box, it is possible to replace the current CRT key with the previous one.

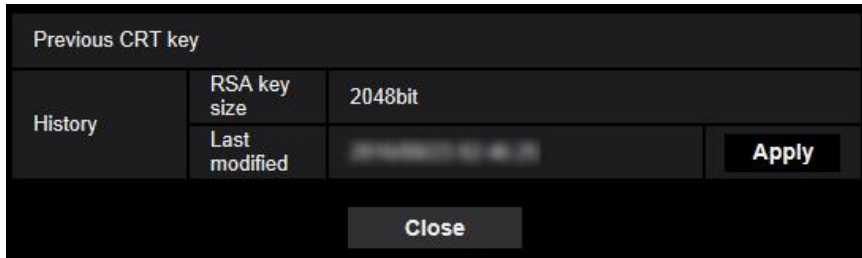

### 2.4.4.2 Generation of CSR (Certificate Signing Request)

**IMPORTANT**

- If the CRT key is not generated, it is impossible to generate the CSR.
  - Before generating the CSR file, configure the following settings on [Internet Options] of the web browser in advance. Click [Internet Options...] under [Tools] of the menu bar of Internet Explorer, and then click the [Security] tab.
    - Register the camera for [Trusted Sites].
    - Click the [Custom level...] button to open the [Security Settings] window, and check the [Enable] radio button of [File Download] under [Downloads].
    - Click the [Custom level...] button to open the [Security Settings] window, and check the [Enable] radio button of [Automatic prompting for file downloads] under [Downloads].
1. Click the [Execute] button of “CA Certificate - Generate Certificate Signing Request”.  
→ The “CA Certificate - Generate Certificate Signing Request” dialog box will be displayed.

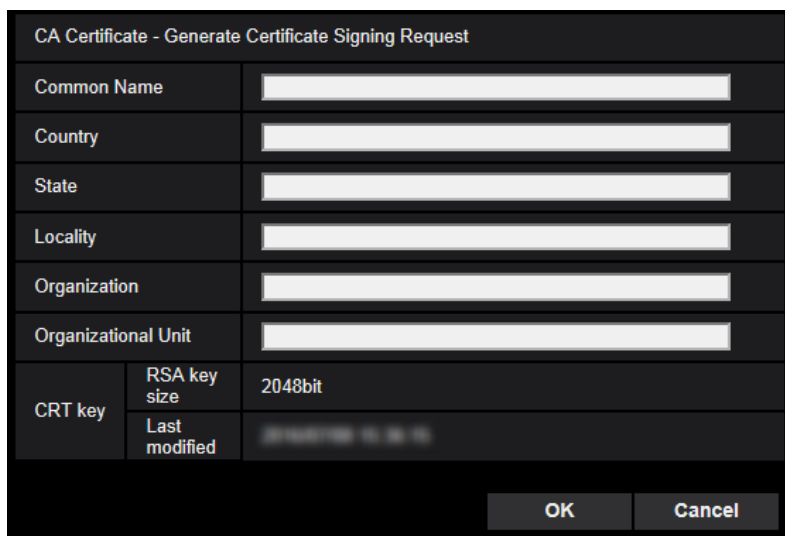



2. Enter the information of the certificate to be generated.

Item	Description	Available number of characters
[Common Name]	Enter the camera address or host name.	64 characters
[Country]	Enter the country name.	2 characters (Country code)
[State]	Enter the state name.	128 characters
[Locality]	Enter the locality name.	128 characters
[Organization]	Enter the organization name.	64 characters
[Organizational Unit]	Enter the unit name of the organization.	64 characters
[CRT key]	Displays the key size and generation time & date of the current key.	—

3. Click the [OK] button after entering the items.

→ The [Save As] dialog box will be displayed.

4. Enter a file name for the CSR in the [Save As] dialog box to save on the PC.

→ The saved CSR file will be applied to the CA.

### **IMPORTANT**

- The certificate will be issued for the set of the generated CSR and CRT key. If the CRT key is re-generated or updated after applying to the CA, the issued certificate will be invalidated.

### **Note**

- This camera generates the CSR file in the PEM format.

## 2.4.4.3 Installation of the certificate issued by CA

### **IMPORTANT**

- If the CSR file is not generated, it is impossible to install the certificate (CA certificate) issued by CA.
- For the installation of the certificate issued by CA, the CA certificate issued by CA is required.

1. Click the [Browse...] button of "CA Certificate - Certificate install".

→ The [Open] dialog box will be displayed.

2. Select the certification file and click the [Open] button. Then, click the [Execute] button.

→ The certification will be installed.

### **Note**

- The host name registered in the installed certificate will be displayed on "CA Certificate - Information". Depending on the status of the certificate, the following are displayed.

Indication	Description
Invalid	The CA certificate is not installed.
[Host name of the certificate]	The certificate has already been installed and validated.
Expired	The certification has already expired.

## 2 Settings

---

- When the [Confirm] button is clicked, the registered information of the installed certificate (CA certificate) will be displayed in the “CA Certificate - Confirm” dialog box. (Only “Organizational Unit” will be displayed with an asterisk (\*).)

CA Certificate - Confirm		
Common Name	NWCAM	
Country	JP	
State	Fukuoka	
Locality	Fukuoka	
Organization	Panasonic	
Organizational Unit	Software*	
CRT key	RSA key size	2048
	Last modified	2023/04/20 10:27:38
<b>Close</b>		

- When the [Delete] button is clicked, the installed certificate (CA certificate) will be deleted.
- When “On” is selected for “Additional info for detecting alteration”, it is impossible to delete the certificate (CA certificate) issued by CA.
- To change (or update) the certificate issued by CA, perform step 1 and 2.

### **IMPORTANT**

- Before deleting the valid certificate (CA certificate), confirm that there is a backup file of the certificate (CA certificate) on the PC or another media. The backup file will be required when installing the certificate (CA certificate) again.
- The expiration date of the certificate issued by CA can be checked by double-clicking the server certification file issued by CA.

### 2.4.4.4 Configuration of alteration detection

1. Select “On” for “Additional info for detecting alteration”, and click the [Set] button.
2. Extensive information for alteration detection will be added to video files (MP4 format) recorded after changing the setting.

### **IMPORTANT**

- When the “Additional info for detecting alteration” setting is changed, manual recording on the SD memory card will stop. Start manual saving again as necessary.

### **Note**

- Alteration detection can be performed on video files (MP4 format) recorded when “On” is selected for “Additional info for detecting alteration” using exclusive software. For further information about exclusive software and how to use it, refer to our website below.  
<https://security.panasonic.com/support/info/>

## 2.4.5 Access copy images saved on the SD memory card onto the PC [SD memory card images]

Click the [SD memory card] tab on the “Basic” page. (→For menu display and how to operate, refer to page 47, page 48)

The following are descriptions of how to copy images saved on the SD memory card onto the PC. It is necessary in advance to select “Allow” for “FTP access to camera” on the [Network] tab of the “Network” page. (→page 185)

### **IMPORTANT**

- It may sometimes be impossible to operate when another user is accessing images on the SD memory card. In this case, retry later.
  - Depending on the settings of a proxy server or a firewall, images may not be obtained via a network. In this case, refer to the network administrator.
1. Click the [Execute] button of “SD memory card images”.  
→ The user authentication window will be displayed.

2. Click the [OK] button after entering the user name and password of the camera administrator.  
→ The folder in which images are to be saved will be displayed.

### **Note**

- When the FTP server of the camera is logged to access images, the SD memory card is assigned to Drive B. Images are saved in different directories according to “Save trigger”. Move to the directory corresponding to the desired images and copy them. Refer to page 271 for further information about the directory structure.

### **Possible number of JPEG images that can be saved on the SD memory card (as indications)**

For possible numbers of JPEG images that can be saved on the SD memory card, refer to our website below.  
<https://security.panasonic.com/support/info/>

### **Possible duration of stream images (H.265 or H.264) that can be saved on the SD memory card (as indications)**

For possible duration of stream images (H.265 or H.264) that can be saved on the SD memory card, refer to our website below.  
<https://security.panasonic.com/support/info/>

## 2.4.6 Configure the directory of the PC that images will be downloaded to [Log]

Click the [Log] tab on the “Basic” page. (→For menu display and how to operate, refer to page 47, page 48)  
The directory of the PC that images recorded on the SD memory card will be downloaded to can be configured in this section.

Category	Stream	Field Label	Value
Alarm	Recording stream 1	Name of the destination directory for downloaded images	C:\nvcam
	Recording stream 2	Name of the destination directory for downloaded images	
Manual/Schedule	Recording stream 1	Name of the destination directory for downloaded images	
	Recording stream 2	Name of the destination directory for downloaded images	
FTP periodic image transmission error	Recording stream 1	Name of the destination directory for downloaded images	C:\nvcam

Set

### Alarm

The settings related to the directory of the PC that recorded images of when alarms occur will be downloaded to can be performed.

#### [Recording stream 1] - [Name of the destination directory for downloaded images]

Enter the name of the destination directory to which images recorded in the recording stream 1 are to be downloaded. For example, enter “C:\alarm” to designate the folder “alarm” under drive C.

- **Available number of characters:** 3 - 128 characters
- **Available characters:** Alphanumeric characters, the slash (/), the backslash (\), the colon (:), and the underscore (\_).

#### [Recording stream 2] - [Name of the destination directory for downloaded images]

Enter the name of the destination directory to which images recorded in the recording stream 2 are to be downloaded. For example, enter “C:\alarm2” to designate the folder “alarm2” under drive C.

- **Available number of characters:** 3 - 128 characters
- **Available characters:** Alphanumeric characters, the slash (/), the backslash (\), the colon (:), and the underscore (\_).

### Manual/Schedule

The settings related to the directory name of the PC that images recorded by manual saving or schedule saving will be downloaded to can be performed.

Designate the destination folder in the same manner as for “Alarm”.

#### Note

- Schedule saving is available only when “Stream(1)”, “Stream(2)”, “Stream(3)”, or “Stream(4)” is selected for “Recording format”.

### FTP periodic image transmission error

The settings related to the directory name of the PC that recorded images of when FTP errors occur will be downloaded to can be performed.

Designate the destination folder in the same manner as for "Alarm".

#### **IMPORTANT**

- When "Name w/o time&date" is selected for "File name" of "FTP periodic image transmission" on the [Advanced] tab on the "Network" page, FTP error log and associated images will not be saved. To save them, select "Name w/time&date". (→page 198)

#### **Note**

- When "Stream(1)", "Stream(2)", "Stream(3)", or "Stream(4)" is selected for "Recording format", "FTP periodic image transmission error" is unavailable.

## 2.5 Configure the settings relating to images and audio [Image/Audio]

The settings relating to JPEG, H.265, and H.264 images such as the settings of image quality, audio, etc. can be configured on this page.

The “Image/Audio” page has the [Image] tab, the [Cam. Function] tab, the [Image/Position] tab, and the [Audio] tab.

### 2.5.1 Configure the settings relating to the image capture mode [Image]

Click the [Image] tab on the “Image/Audio” page. (→For menu display and how to operate, refer to page 47, page 48)

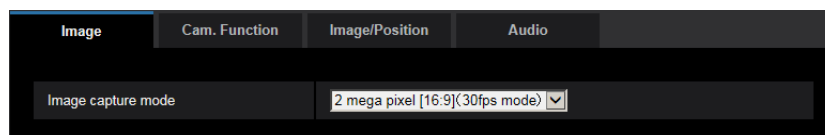

#### [Image capture mode]

- **X6531** **S6131** **S6530** **S6130**  
 2 mega pixel [16:9](30fps mode)/2 mega pixel [16:9](60fps mode)/3 mega pixel [4:3](30fps mode)  
 – **Default:** 2 mega pixel [16:9](30fps mode)
- **X6511** **S6111**  
 1.3 mega pixel [16:9](30fps mode)/1.3 mega pixel [16:9](60fps mode)/1.3 mega pixel [4:3](30fps mode)  
 – **Default:** 1.3 mega pixel [16:9](30fps mode)

#### **IMPORTANT**

- The positions of areas may move out of alignment when the “Image capture mode” setting is changed when the following area settings are configured. Therefore we recommend that you configure each area setting after configuring the “Image capture mode”.
  - mask area (→page 121)
  - privacy zone (→page 138)
  - VMD area (→page 165)
  - VIQS area (→page 141)

#### **Note**

- When 2 mega pixel [16:9](60fps mode) or 1.3 mega pixel [16:9](60fps mode) is selected, 60 fps transmission may not be available for the multiple stream transmission and the image may be intermittently displayed. Also, when the audio is simultaneously transmitted, 30 fps transmission will be applied. For other stream transmission conditions, refer to our website below.  
<https://security.panasonic.com/support/info/>
- When “VIQS Area” is enabled, and the setting value for the aspect ratio is changed from “4:3” to “16:9”, make sure that the VIQS setting value does not exceed the maximum designated range.

## 2.5.2 Configure the settings relating to JPEG images [Image]

Click the [Image] tab on the “Image/Audio” page. (→For menu display and how to operate, refer to page 47, page 48)

"Live" page (Initial display)		
Initial display stream	Stream(1) <input type="checkbox"/>	
Refresh interval (JPEG) *	5fps <input type="checkbox"/>	
JPEG		
JPEG(1)	Image capture size	1920x1080 <input type="checkbox"/>
	Image quality	5 Normal <input type="checkbox"/>
JPEG(2)	Image capture size	640x360 <input type="checkbox"/>
	Image quality	5 Normal <input type="checkbox"/>
JPEG(3)	Image capture size	320x180 <input type="checkbox"/>
	Image quality	5 Normal <input type="checkbox"/>

### “Live” page (Initial display)

Configure the settings relating to the initial images displayed on the “Live” page.

#### [Initial display stream]

Select the image to display on the “Live” page from the following.

JPEG(1)/JPEG(2)/JPEG(3)/Stream(1)/Stream(2)/Stream(3)/Stream(4)/Multi-screen

- **Default:** Stream(1)

#### Note

- When “JPEG(1)”, “JPEG(2)”, or “JPEG(3)” is selected, the refresh interval can be selected.  
 MJPEG/Refresh interval: 1s/Refresh interval: 3s/Refresh interval: 5s/Refresh interval: 10s/Refresh interval: 30s/Refresh interval: 60s

#### [Refresh interval (JPEG)\*]

Select an interval to refresh the displayed JPEG image from the following.

0.1fps/0.2fps/0.33fps/0.5fps/1fps/2fps/3fps/5fps/6fps\* /10fps\*/12fps\*/15fps\*/30fps\*

- **Default:** 5fps

#### Note

- When “On” is selected for “Stream transmission”, the refresh interval may be longer than the set value when any value with an asterisk (\*) on the right is selected.
- Depending on factors such as the network environment, the resolution, the image quality, or the number of computers concurrently accessing the camera, the transmission interval may be longer than the set value.
- If images are not delivered in the specified transmission interval, you can make the images be delivered closer to the specified time by lowering the resolution or image quality.

## JPEG

Configure the settings such as “Image capture size”, “Image quality” of “JPEG(1)”, “JPEG(2)”, and “JPEG(3)” on this section. Refer to page 98 for further information about the settings relating to H.265 (or H.264) images.



**[Image capture size]**

Select the image capture size to display the JPEG image.

**X6531** **S6131** **S6530** **S6130**

Image capture mode	JPEG(1)	JPEG(2)	JPEG(3)
2 mega pixel [16:9](30fps mode)	1920×1080 1280×720 640×360 320×180	1920×1080 1280×720 640×360 320×180	640×360 320×180
2 mega pixel [16:9](60fps mode)	1920×1080 1280×720 640×360 320×180	1920×1080 1280×720 640×360 320×180	640×360 320×180
3 mega pixel [4:3](30fps mode)	2048×1536 1280×960 800×600 VGA 400×300 QVGA	1280×960 800×600 VGA 400×300 QVGA	VGA 400×300 QVGA

- **Default:**
  - JPEG(1): 1920x1080
  - JPEG(2): 640x360
  - JPEG(3): 320x180

**X6511** **S6111**

Image capture mode	JPEG(1)	JPEG(2)	JPEG(3)
1.3 mega pixel [16:9](30fps mode)	1280×720 640×360 320×180	1280×720 640×360 320×180	640×360 320×180
1.3 mega pixel [16:9](60fps mode)	1280×720 640×360 320×180	1280×720 640×360 320×180	640×360 320×180
1.3 mega pixel [4:3](30fps mode)	1280×960 800×600 VGA 400×300 QVGA	1280×960 800×600 VGA 400×300 QVGA	VGA 400×300 QVGA

- **Default:**
  - JPEG(1): 1280x720
  - JPEG(2): 640x360
  - JPEG(3): 320x180

**[Image quality]**

Select the image quality of JPEG images for each image capture size.

0 Super fine/ 1 Fine/ 2/ 3/ 4/ 5 Normal/ 6/ 7/ 8/ 9 Low

- **Default:** 5 Normal

### 2.5.3 Configure the settings relating to Stream [Image]

Click the [Image] tab on the “Image/Audio” page. (→For menu display and how to operate, refer to page 47, page 48)

Configure the settings relating to H.265 (or H.264) image such as “Max bit rate (per client)”, “Image capture size”, “Image quality”, etc. in this section. Refer to page 96 for the settings relating to JPEG images.

Stream(1)	
Stream transmission	<input type="radio"/> On <input checked="" type="radio"/> Off
Stream encoding format	<input type="radio"/> H.265 <input checked="" type="radio"/> H.264
Internet mode (over HTTP)	<input checked="" type="radio"/> On <input type="radio"/> Off
Image capture size	1920x1080
Transmission priority	Frame rate
Frame rate*	30fps*
Max bit rate (per client) *	3072kbps*
Image quality	Normal
Smart Coding	GOP control
	Smart Facial Coding
Refresh interval	1s
Transmission type	Unicast port (AUTO)
Unicast port1(Image)	32004 (1024-50000)
Unicast port2(Audio)	34004 (1024-50000)
Multicast address	239.192.0.20
Multicast port	37004 (1024-50000)
Multicast TTL/HOPLimit	16 (1-254)

### Stream(1)/Stream(2)/Stream(3)/Stream(4)

#### [Stream transmission]

Select “On” or “Off” to determine whether or not to transmit H.265 (or H.264) images.

- **On:** Transmits H.265 (or H.264) images.
- **Off:** Does not transmit H.265 (or H.264) images.
- **Default:** On

#### Note

- When “On” is selected for “Stream transmission” in “Stream(1)”, “Stream(2)”, “Stream(3)”, or “Stream(4)” displaying of H.265 (or H.264) images or JPEG images on the “Live” page will become available.
- When “On” is selected for “Stream transmission” for “Stream(1)”, “Stream(2)”, “Stream(3)”, or “Stream(4)”, the refresh interval of JPEG images is limited to a maximum of 5 fps.

#### [Stream encoding format]

Select the stream encoding format for transmission.

- **H.265:** Transmits H.265 images.
- **H.264:** Transmits H.264 images.
- **Default:** H.265

**[Internet mode (over HTTP)]**

Select "On" when transmitting H.265 (or H.264) images via the Internet. It is possible to transmit stream without changing the broadband router settings configured for JPEG image transmission.

- **On:** H.265 (or H.264) images and audio will be transmitted using the HTTP port. Refer to page 188 for further information about the HTTP port number settings.
- **Off:** H.265 (or H.264) images and audio will be transmitted using the UDP port.
- **Default:** Off

**Note**

- When "On" is selected, only "Unicast port (AUTO)" will be available for "Transmission type".
- When "On" is selected, it may take time to start displaying stream images.
- When "On" is selected, stream images may not be displayed depending on the number of the concurrent access user and audio data availability, etc.
- When "On" is selected, only IPv4 access is available.

**[Image capture size]**

Select the image capture size from the following. What can be selected may be limited depending on the image capture size already selected.

**X6531** **S6131** **S6530** **S6130**

Image capture mode	Stream(1)	Stream(2)	Stream(3)	Stream(4)
2 mega pixel [16:9](30fps mode)	1920×1080 1280×720 640×360 320×180	1920×1080 1280×720 640×360 320×180	1280×720 640×360 320×180	640×360 320×180
2 mega pixel [16:9](60fps mode)	1920×1080 1280×720	1920×1080 1280×720 640×360 320×180	1280×720 640×360 320×180	640×360 320×180
3 mega pixel [4:3](30fps mode)	2048×1536 1280×960 800×600 VGA 400×300 QVGA	1280×960 800×600 VGA 400×300 QVGA	VGA 400×300 QVGA	VGA 400×300 QVGA

**X6511** **S6111**

Image capture mode	Stream(1)	Stream(2)	Stream(3)	Stream(4)
1.3 mega pixel [16:9] (30fps mode)	1280×720 640×360 320×180	1280×720 640×360 320×180	1280×720 640×360 320×180	640×360 320×180
1.3 mega pixel [16:9] (60fps mode)	1280×720	1280×720 640×360 320×180	1280×720 640×360 320×180	640×360 320×180

## 2 Settings

Image capture mode	Stream(1)	Stream(2)	Stream(3)	Stream(4)
1.3 mega pixel [4:3] (30fps mode)	1280×960 800×600 VGA 400×300 QVGA	1280×960 800×600 VGA 400×300 QVGA	VGA 400×300 QVGA	VGA 400×300 QVGA

- Default:**

**X6531** **S6131** **S6530** **S6130**

- Stream(1): 1920x1080
- Stream(2): 640x360
- Stream(3): 320x180
- Stream(4): 320x180

**X6511** **S6111**

- Stream(1): 1280x720
- Stream(2): 640x360
- Stream(3): 320x180
- Stream(4): 320x180

### [Transmission priority]

Select a transmission priority for “Stream” from the following.

- **Constant bit rate:** H.265 (or H.264) images will be transmitted with the bit rate selected for “Max bit rate (per client)\*”.
- **VBR:** H.265 (or H.264) images will be transmitted with the frame rate selected for “Frame rate\*” while maintaining the image quality level selected in “Image quality”. In this case, images will be transmitted with the bit rate kept within the maximum bit rate that is set for “Max bit rate (per client)\*”. The image quality is fixed, and the recording capacity changes according to the “Image quality” setting and conditions of the subject.
- **Frame rate:** H.265 (or H.264) images will be transmitted with the frame rate selected for “Frame rate\*”.
- **Best effort:** In accordance with the network bandwidth, H.265 (or H.264) images will be transmitted with the maximum bit rates that are set for “Max bit rate (per client)\*”.
- **Default:** Frame rate

### Note

- When “Frame rate” is set for “Transmission priority”, number of users who can access the camera may be limited.

### [Frame rate\*]

Select a frame rate from the following.

1fps/ 3fps/ 5fps\*/ 7.5fps\*/ 10fps\*/ 12fps\*/ 15fps\*/ 20fps\*/ 30fps\*/ 60fps\*

- **Default:** 30fps\*

### Note

- “Frame rate\*” is restricted by “Max bit rate (per client)\*”. For this reason, the frame rate may be lower than the specified value when any value marked with an asterisk (\*) is selected. When “VBR” is selected for “Transmission priority”, depending on the settings of “Max bit rate (per client)\*” and “Image quality”, transmission of images may periodically be paused. Check the transmission of images after changing settings.
- When the “Image capture mode” is set as “2 mega pixel [16:9](60fps mode)” or “1.3 mega pixel [16:9] (60fps mode)”, Stream(1) is fixed to 60fps. Also, Stream(2) to Stream(4) can select up to a maximum of 30fps.

- Depending on the number users connecting at the same time or the combination of features used, the frame rate may be lower than the configured value. Check the transmission of images after changing settings.







### [Max bit rate (per client)\*]

Select an H.265 (or H.264) bit rate per a client from the following.

When “-- FREE ENTRY --” is selected, the bit rate can be freely entered .









64kbps/ 128kbps\*/ 256kbps\*/ 384kbps\*/ 512kbps\*/ 768kbps\*/ 1024kbps\*/ 1536kbps\*/ 2048kbps\*/ 3072kbps\*/ 4096kbps\*/ 6144kbps\*/ 8192kbps\*/ 10240kbps\*/ 12288kbps\*/ 14336kbps\*/ 16384kbps\*/ 20480kbps\*/ 24576kbps\*/ -- FREE ENTRY --

- Default:**









- Stream(1): 3072kbps\*     / 2048kbps\*  
- Stream(2): 1536kbps\*
- Stream(3): 1024kbps\*
- Stream(4): 1024kbps\*

\* The range of bit rates that can be configured for H.265 (or H.264) bit rates differs depending on the “Transmission priority” and “Image capture size”.

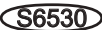
When “Constant bit rate”, “Frame rate”, or “Best effort” is selected for “Transmission priority”

- QVGA, 400x300, VGA, 320x180, and 640x360: 64kbps - 4096kbps\*
- 800x600: 128kbps\* - 4096kbps\*
- 1280x960 and 1280x720<sup>1</sup>: 256kbps\* - 8192kbps\*
- 1920x1080<sup>1</sup>: 512kbps\* - 12288kbps\*    
- 2048x1536: 1024kbps\* - 16384kbps\*    

When “VBR” is selected for “Transmission priority”

- QVGA, 400x300, VGA, 320x180<sup>1</sup>, and 640x360<sup>1</sup>: 64kbps - 12288kbps\*
- 800x600: 128kbps\* - 12288kbps\*
- 1280x960 and 1280x720<sup>1</sup>: 256kbps\* - 12288kbps\*
- 1920x1080<sup>1</sup>: 512kbps\* - 24576kbps\*    
- 2048x1536: 1024kbps\* - 24576kbps\*    

<sup>1</sup> When 60fps mode is selected, settings up until 24576kbps can be configured.

### Note

- The bit rate for “Stream” is restricted by “Bandwidth control(bit rate)” on the [Network] tab on the “Network” page (→page 185). When a value with “\*” attached is set, images may not be streamed.
- Depending on the number users connecting at the same time or the combination of features used, the frame rate may be lower than the configured value. Check the transmission of images after changing settings.

### [Image quality]

Select the image quality of H.265 (or H.264) images from the following.

- For “Constant bit rate”, “Frame rate”, and “Best effort”:** Motion priority/Normal/Quality priority
- “VBR”:** 0 Super fine/ 1 Fine/ 2/ 3/ 4/ 5 Normal/ 6/ 7/ 8/ 9 Low
- Default:** 5 Normal

### [Smart Coding] - [GOP control]

By using “GOP control”, the transmission data volume can be reduced when there is little motion in the image.

- When “H.265” is selected as the “Stream encoding format”: Off/On(Low)/On(Mid)/On(Advanced)
- When “H.264” is selected as the “Stream encoding format”: Off/On(Low)/On(Mid)

- **Default:** Off

### **IMPORTANT**

- If any of “On(Low)”, “On(Mid)”, or “On(Advanced)” is selected, recording the target stream to the SD memory card is not available.

### **Note**

- “On(Low)” and “On(Mid)” are available only when “VBR” is selected for “Transmission priority”.
- “On(Advanced)” can be set regardless of the “Transmission priority” setting.
- When using “GOP control”, the refresh interval is increased when streaming H.265 (or H.264) images. For this reason, do not use it when the network environment has frequent errors.
- During pan/ tilt/ zoom/ focus operation, the effect of the smart coding may not be obtained.

### **[Smart Coding] - [Smart Facial Coding]**

Maintains high image quality in the areas of the image containing people's faces and moving objects, and reduces the transmission data volume in other areas of the image.

- **Off:** Does not use “AUTO VIQS” and “Smart Facial Coding”.
- **On(AUTO VIQS):** Maintains high image quality in the areas of the image containing moving objects, and reduces the transmission data volume in other areas of the image.
- **On(Smart Facial Coding):** Maintains high image quality in the areas of the image containing people's faces and moving objects, and reduces the transmission data volume in other areas of the image.
- **Default:** Off

### **Note**

- This feature can only be used for “Stream(1)”.
- When “2 mega pixel [16:9](60fps mode)” or “1.3 mega pixel [16:9](60fps mode)” is selected for “Image capture mode”, this function is not available.
- When using this function, “VIQS” of “Image/Position” will be disabled.
- When the camera is used in environments of 40°C or higher, the effectiveness of the smart facial coding will be reduced.
- Depending on the object, a high image quality may be maintained even in areas that do not contain a person's face.
- When “On” is selected for “Stabilizer”, “Smart Facial Coding” is not available.

### **[Refresh interval]**

Select an interval (I-frame interval; 0.2 - 5 seconds) to refresh the displayed H.265 (or H.264) images from the following.

If using under a network environment with frequent error occurrences, shorten the refresh interval for H.265 (or H.264) to diminish image distortions. However, the refresh interval may be longer than the set value.

0.2s/ 0.25s/ 0.33s/ 0.5s/ 1s/ 2s/ 3s/ 4s/ 5s

- **Default:** 1s

### **Note**

- When “On(Low)” is selected for “GOP control”, the refresh interval is set to Max. 8s.
- When “On(Mid)” is selected for “GOP control”, the refresh interval is set to Max. 16s.
- When “On(Advanced)” is selected for “GOP control”, the refresh interval is set to 60s.

### **[Transmission type]**

Select the transmission type of H.265 (or H.264) images from the following.

- **Unicast port (AUTO):** Up to 14 users can access a single camera concurrently. “Unicast port1(Image)” and “Unicast port2(Audio)” will automatically be selected when transmitting images and audio from the camera. When it is unnecessary to fix the port number for stream transmission such as when using in a particular LAN environment, it is recommended to select “Unicast port (AUTO)”.

- **Unicast port (MANUAL):** Up to 14 users can access a single camera concurrently. It is necessary to select “Unicast port1(Image)” and “Unicast port2(Audio)” manually to transmit images and audio from the camera. It is possible to fix the port number of the router used for stream transmission via the Internet by setting “Unicast port (MANUAL)” (→page 185). Refer to the operating instructions of the router in use.
- **Multicast:** Unlimited number of users can access a single camera concurrently. Complete the entry field of “Multicast address”, “Multicast port” and “Multicast TTL/HOPLimit” when transmitting stream with multicast. Refer to page 9 for further information about the maximum concurrent access number.
- **Default:** Unicast port (AUTO)

### [Unicast port1(Image)]<sup>1</sup>

Enter the unicast port number (used to transmit images from the camera).

- **Available port number:** 1024 - 50000 (Only even numbers are available.)
- **Default:**
  - Stream(1): 32004
  - Stream(2): 32014
  - Stream(3): 32024
  - Stream(4): 32034

### [Unicast port2(Audio)]<sup>1</sup>

Enter the unicast port number (used to transmit audio from the camera).

- **Available port number:** 1024 - 50000 (Only even numbers are available.)
- **Default:**
  - Stream(1): 33004
  - Stream(2): 33014
  - Stream(3): 33024
  - Stream(4): 33034

### [Multicast address]<sup>2</sup>

Enter the multicast IP address. Images and audio will be transmitted to the designated IP address.

- **Available IPv4 address:** 224.0.0.0 - 239.255.255.255
- **Available IPv6 address:** Multicast address starting with “FF”
- **Default:**
  - Stream(1): 239.192.0.20
  - Stream(2): 239.192.0.21
  - Stream(3): 239.192.0.22
  - Stream(4): 239.192.0.23

#### Note

- Enter a multicast IP address after checking available multicast address.

### [Multicast port]<sup>2</sup>

Enter the multicast port number (used to transmit images from the camera).

- **Available port number:** 1024 - 50000 (Only even numbers are available.)
- **Default:** 37004

#### Note

- When audio is transmitted from the unit, the port number to be used will be the multicast port number plus “1000”.

### [Multicast TTL/HOPLimit]<sup>2</sup>

Enter a value for “Multicast TTL/HOPLimit”.

- **Available value:** 1-254

## 2 Settings

---

- **Default:** 16

### **IMPORTANT**

- When transmitting stream images via the internet, the transmitted image sometimes may not be displayed depending on the settings of a proxy server or a firewall. In this case, refer to the network administrator.
- When two or more network interface cards are installed on the PC in use, the network interface card(s) not used for receiving images should be invalidated when displaying images using the multicast port.

---

<sup>\*1</sup> It is necessary to designate the unicast port number when “Unicast port (MANUAL)” is selected for “Transmission type”.

<sup>\*2</sup> It is necessary to designate the multicast IP address when “Multicast” is selected for “Transmission type”.



## 2.5.4 Configure the settings relating to the camera operations [Cam. Function]

Click the [Cam. Function] tab on the “Image/Audio” page. (→For menu display and how to operate, refer to Page 47, Page 48)

The settings relating to the camera operation can be configured in this section.

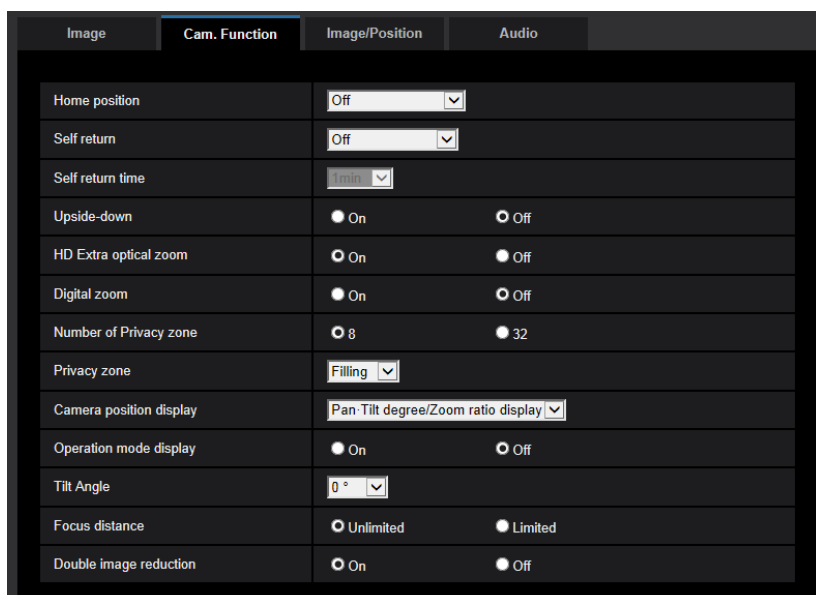

### [Home position]

A preset position (→Page 123) can be set as the home position.

When a preset position is set as the home position, “H” will be displayed next to the preset position number.

- **Default:**Off

### Note

- To move the camera to the home position when the power of the camera is turned on, select “Home position” for “Self return”.

### [Self return]

When the time set for “Self return time” has passed after manual operations of the camera, the camera will automatically be in the selected mode.

- **Off:** Self return is not performed.
- **Home position:** When the set time has passed, the camera will move to the home position automatically.
- **Auto track:** When the set time has passed, the camera will move to the home position and will start the advanced auto track function. The camera will repeat this action (moving to the home position and starting the auto track function) afterward.
- **Auto pan:** When the set time has passed, the camera will start the auto pan function.
- **Preset sequence:** When the set time has passed, the camera will start the sequence display.
- **Patrol:** When the set time has passed, the camera will start the patrol.
- **Default:** Off

### Note

- This function is also useful to automatically set the camera in a specific mode when the power of the camera is turned on.
- The self return function works even when the setup menu is displayed.

- “Patrol” can be set only when the patrol function is enabled (→Page 129).

### [Self return time]

Select a waiting time (amount of time until the camera starts the selected operation after the end of the manual operations) from the following.

10s/ 20s/ 30s/ 1min/ 2min/ 3min/ 5min/ 10min/ 20min/ 30min/ 60min

- **Default:** 1min

### [Upside-down] **X6531** **X6511** **S6131** **S6111** **S6530**

Select “On” or “Off” to determine whether or not to turn the image upside-down.

- **On:** The image is turned upside-down.
- **Off:** The image is not turned upside-down.
- **Default:** Off

### [Upside-down] **S6130**

Select how to install the camera.

- **On (desktop):** Select this when installing the camera onto the desk.
- **Off (ceiling):** Select this when installing the camera to the ceiling.
- **Default:** Off (ceiling)

### [HD Extra optical zoom]

Select the HD extra optical zoom setting from the following:

- **On:** **X6531** **X6511** **S6131** **S6111** Images can be zoomed in on with the optical zoom (1x - 40x) and the HD extra optical zoom (higher zoom factors, up to 60x).
- **On:** **S6130** **S6530** Images can be zoomed in on with the optical zoom (1x - 21x) and the HD extra optical zoom (higher zoom factors, up to 31x).
- **Off:** Does not use the HD extra optical zoom. The range is within the optical zoom.  
Optical zoom factor: 1x - 40x **X6531** **X6511** **S6131** **S6111**  
Optical zoom factor: 1x - 21x **S6130** **S6530**
- **Default:** On

### About HD extra optical zoom

Among the valid pixels of the MOS image sensor, the central part of approx. 0.92 megapixels (equivalent to the image capture size of 1280x720) is extracted for shooting. That enables shooting with a higher zooming effect when the image capture size of 1280x720 or lower is used.

### [Digital zoom]

Select the digital zoom setting from the following.

- **On:** **X6531** **X6511** **S6131** **S6111** Images can be zoomed in on with the optical zoom (1x - 40x), HD extra optical zoom (up to 60x), and the digital zoom (higher zoom factors, up to 640x).
- **On:** **S6130** **S6530** Images can be zoomed in on with the optical zoom (1x - 21x), HD extra optical zoom (up to 31x), and the digital zoom (higher zoom factors, up to 336x).
- **Off:** Does not use the digital zoom.
- **Default:** Off

### Note

- When “On” is selected for the digital zoom, zooming will stop once right before the zoom factor is shifting to the digital zoom.
- With the digital zoom factor, the setting of the preset positions will become unavailable.
- When the image capture size is “2048x1536”, “QVGA”, or “320x180”, the digital zooming may be cancelled if the zoom factor exceeds the following:

360x: **X6531** **X6511** **S6131** **S6111**

180x: **S6130** **S6530**

- When “Off” is selected for “HD Extra optical zoom”, “On” cannot be set for “Digital zoom”.

### [Number of Privacy zone]

Select the number of privacy zones that can be configured from the following.

- **8:** Up to 8 privacy zones can be configured.
- **32:** Up to 32 privacy zones can be configured.
- **Default:** 8

#### Note

- A maximum of 8 privacy zones can be displayed on 1 screen simultaneously.

### [Privacy zone]

Select a display type of the privacy zone from the following.

- **Filling:** The privacy zones will be displayed in gray.
- **Mosaic:** The privacy zones will be displayed with a mosaic effect.
- **Off:** Does not display the privacy zones.
- **Default:** Filling

### [Camera position display] **X6531** **X6511** **S6131** **S6111**

When operating the camera manually, you can select what information to display in the image from the following.

- **Off:** Information is not displayed in the image.
- **Pan-Tilt degree/Zoom ratio display:** The Pan degree/Tilt degree/Zoom ratio display is displayed.
- **Direction display:** Direction display is displayed.
- **Default:** Pan-Tilt degree/Zoom ratio display

#### Note

- When “Pan-Tilt degree/Zoom ratio display” is selected, the Pan-Tilt degree/Zoom ratio display is displayed in the position specified in “OSD” on the [Basic] tab. (→Page 73)
- When “Direction display” is selected, the direction is displayed in the position specified in “OSD” on the [Basic] tab. (→Page 73)
- When “Direction display” is selected, configure the direction of north in “North point setting” of “Direction/Angle setting”. (→Page 138)

### [Pan-Tilt degree/Zoom ratio display] **S6130** **S6530**

Select “On” or “Off” to determine whether to enable or disable the Pan degree/Tilt degree/Zoom ratio display.

- **On:** The Pan degree/Tilt degree/Zoom ratio display is displayed.
- **Off:** The Pan degree/Tilt degree/Zoom ratio display is not displayed.
- **Default:** On

#### Note

- When “On” is selected, the Pan-Tilt degree/Zoom ratio display is displayed in the position specified in “OSD” on the [Basic] tab. (→Page 73)

### [Operation mode display]

When the camera is operating automatically, the operation mode is displayed.

- **On:** Displays the operation mode.
- **Off:** Does not display the operation mode.
- **Default:** Off

Operation mode	Display
The camera is initializing.	INITIAL
The camera is auto panning.	AUTO PAN
The camera is waiting to start auto tracking.	AUTO TRACK WAITING
The camera is auto tracking.	AUTO TRACKING
The camera is patrolling.	PATROL
The camera is moving through the preset sequences.	PRESET SEQ

**[Pan/tilt-flip]** **S6130** **S6530**

Select the pan/tilt-flip setting from the following:

- **On:** In the manual operation, when the camera is fully panned or tilted (reaches right below), the camera automatically pans at high speed to the reverse direction and continues operation without stopping at the pan- or tilt-endpoint.
- **Off:** Pan/tilt-flip does not work.
- **Default:** On

**Note**

- At TELE side, a partially invisible section may be generated when using the Pan/tilt-flip function.
- Click a desired point in the main area on the “Live” page that is to be the center of the angle of view. The camera will move to adjust the position in order to set the clicked point as the center. At this time, the camera continues to operate without stopping at the pan- or tilt-endpoint.

**[Tilt Angle]**

Select the maximum degree for tilting from the following. (Level = 0°)

- **X6531** **X6511**: 10°/ 5°/ 3°/ 0°/ -3°/ -5°/ -10°/ -15°
- **S6131** **S6111**: 10°/ 5°/ 3°/ 0°/ -3°/ -5°/ -10°/ -15°/ -20°/ -25°
- **S6130** **S6530**: 10°/ 5°/ 3°/ 0°/ -3°/ -5°/ -10°/ -15°/ -20°/ -25°/ -30°

**Default:** 0°

**Note**

- **S6130**
  - When using an inner cover (an accessory of optional mount bracket), upper side of the image will be hidden if the camera faces horizontal direction. When “-5°” is selected for “Tilt Angle”, the upper half of the image will be hidden. Also, if the setting of “Maximum gain” (→Page 115) is too large, the image will become white depending on the subject.
- **S6530** **X6531** **X6511**
  - When the camera reaches horizontal or further, the image on the screen blocked by the camera housing increases.

**[Focus Distance]**

When shooting a subject through glass or when an object other than the subject is close to the camera when shooting, it may be difficult to focus on the subject. In this case, the minimum focus distance can be limited.

- **Unlimited:** Does not limit the minimum focus distance.
- **Limited:** The minimum focus distance is limited so that objects near the camera are not focused on.
- Focus distance **X6531** **X6511** **S6131** **S6111**: Approx. 3 m

Focus distance **S6130** **S6530**: Approx. 1.5 m

**Default:** Unlimited

**[Double image reduction]** **X6531** **X6511**

When shooting subjects horizontally, the light coming into the lens can be limited in order to make images clearer.

- **On:** Limits the light coming into the lens.
- **Off:** Does not limit the light coming into the lens.
- **Default:** On

## 2.5.5 Configure the settings relating to images and the preset positions [Image/Position]

Click the [Image/Position] tab on the “Image/Audio” page. (→For menu display and how to operate, refer to page 47, page 48)

When the [Setup>>] button of each setting item is clicked, the detailed settings menu will be displayed in a newly opened window. The detailed settings can be configured while monitoring images displayed on the [Image/Position] tab.

The settings relating to image adjust, preset positions, auto panning, patrol, auto-tracking, direction/angle, privacy zone, and VIQS can be configured in this section.

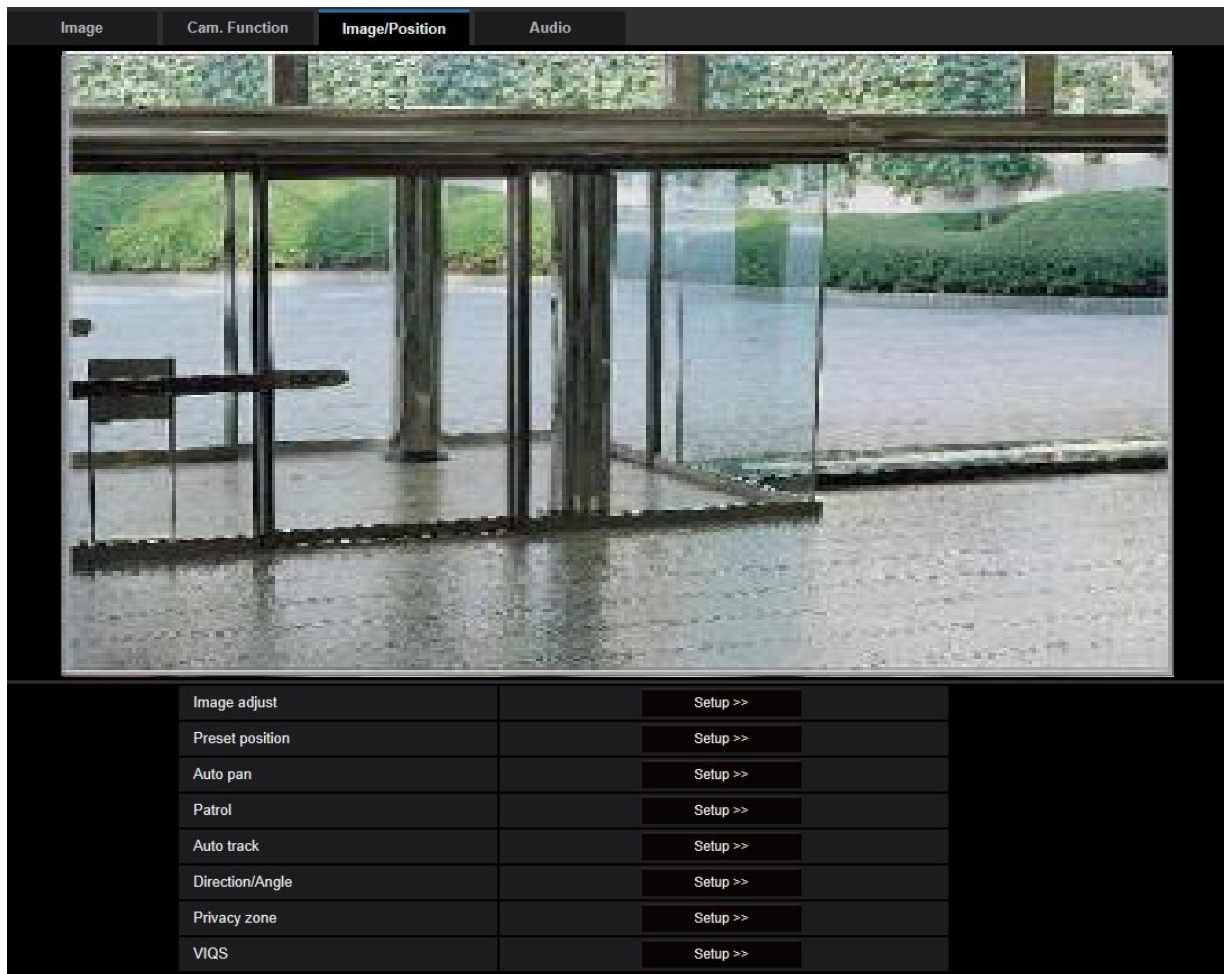

### [Image adjust]

Click the [Setup>>] button to display the setup menu that can configure the settings relating to image quality. The setup menu will be displayed in a newly opened window. (→Page 111)

### [Preset position]

Click the [Setup>>] button to display the setup menu that can configure the preset position. The setup menu will be displayed in a newly opened window. (→Page 123)

**[Auto pan]**

Click the [Setup>>] button to display the setup menu that can configure the settings relating to the auto-panning function. The setup menu will be displayed in a newly opened window. (→Page 127)

**[Patrol]**

Click the [Setup>>] button to display the setup menu that can configure the settings relating to the patrol function. The setup menu will be displayed in a newly opened window. (→Page 129)

**[Auto track]**

Click the [Setup>>] button to display the setup menu that can configure the settings relating to the auto track function. The setup menu will be displayed in a newly opened window. (→Page 131)

**[Direction/Angle]**

Click the [Setup>>] button to display the setup menu that can configure the settings relating to the direction/angle setting function. The setup menu will be displayed in a newly opened window. (→Page 137)

**[Privacy zone]**

Click the [Setup>>] button to display the setup menu that can configure the settings relating to the privacy zone. The setup menu will be displayed. (→Page 138)

**[VIQS]**

Click the [Setup>>] button to display the setup menu that can configure the settings relating to VIQS. The setup menu will be displayed. (→Page 141)

\* VIQS is an abbreviation of Variable Image Quality on Specified area and is a feature that enables you to enhance the image quality of specified areas in images.

### 2.5.5.1 Configure the settings relating to image quality (“Image adjust” setup menu)

Click the [Setup>>] button of “Image adjust” on the [Image/Position] tab of the “Image/Audio” page. (→page 105)

The settings relating to image quality can be configured with the setup menu displayed in a newly displayed window. When the values are changed, the changed values will be applied to the currently displayed image on the [Image/Position] tab.

Click the “+” mark on the left of each item in the setup menu to expand the respective item, and enable detailed settings.

Click the “-” mark on the left of an expanded item to return to the screen displayed before the item was expanded.

<Example: Super dynamic (SD)>

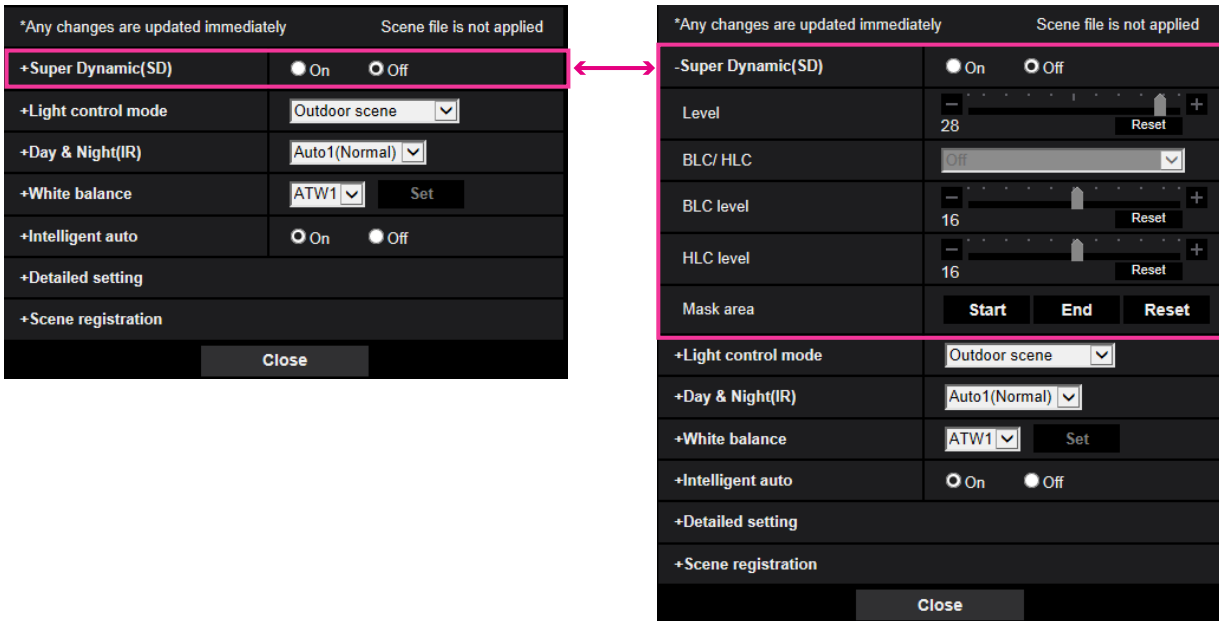

## Super Dynamic(SD)

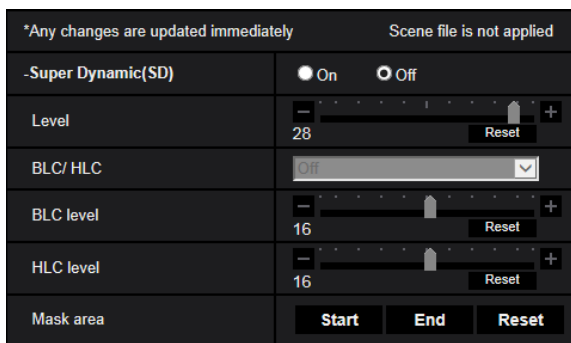

### [Super Dynamic(SD)]

Select “On” or “Off” to determine whether or not to activate the super dynamic function.

This is not available when “Image capture mode” is set to “2 mega pixel [16:9](60fps mode)” or “1.3 mega pixel [16:9](60fps mode)”.

Refer to the description “Super Dynamic function” (→Page 113) about the super dynamic function.

- **On:** The super dynamic function will work.
- **Off:** The super dynamic function will not work.
- **Default:** Off

### Note

- When the camera is used in environments of 40°C or higher, the effectiveness of the super dynamic function will be reduced.

### [Level]

Adjust the super dynamic (SD) level.

If you move the slider in the “+” direction, a subject with high contrast can be captured without over exposure or under exposure.



If you move the slider in the “-” direction, the parts with medium brightness can be captured with rich gradation. Click the [Reset] button to reset to the default setting.

- **Default:** 28

#### Note

- When the following are observed depending on the light condition, select “Off” for “Super Dynamic(SD)”.
  - When flickering appears or the color changes on the screen
  - When noise appears in the brighter area on the screen

#### Super Dynamic function

When there is wide variation between the illumination of light and dark areas of the location being monitored, the camera adjusts the lens iris in accordance with the brighter areas. This causes loss of detail in darker areas. Conversely, adjusting the lens brightness for the darker areas causes the brighter areas to become washed out.

Super Dynamic digitally combines an image that is set up for a clear view of the brighter areas with an image that is set up for a clear view of the darker areas, creating a final image that preserves overall detail.

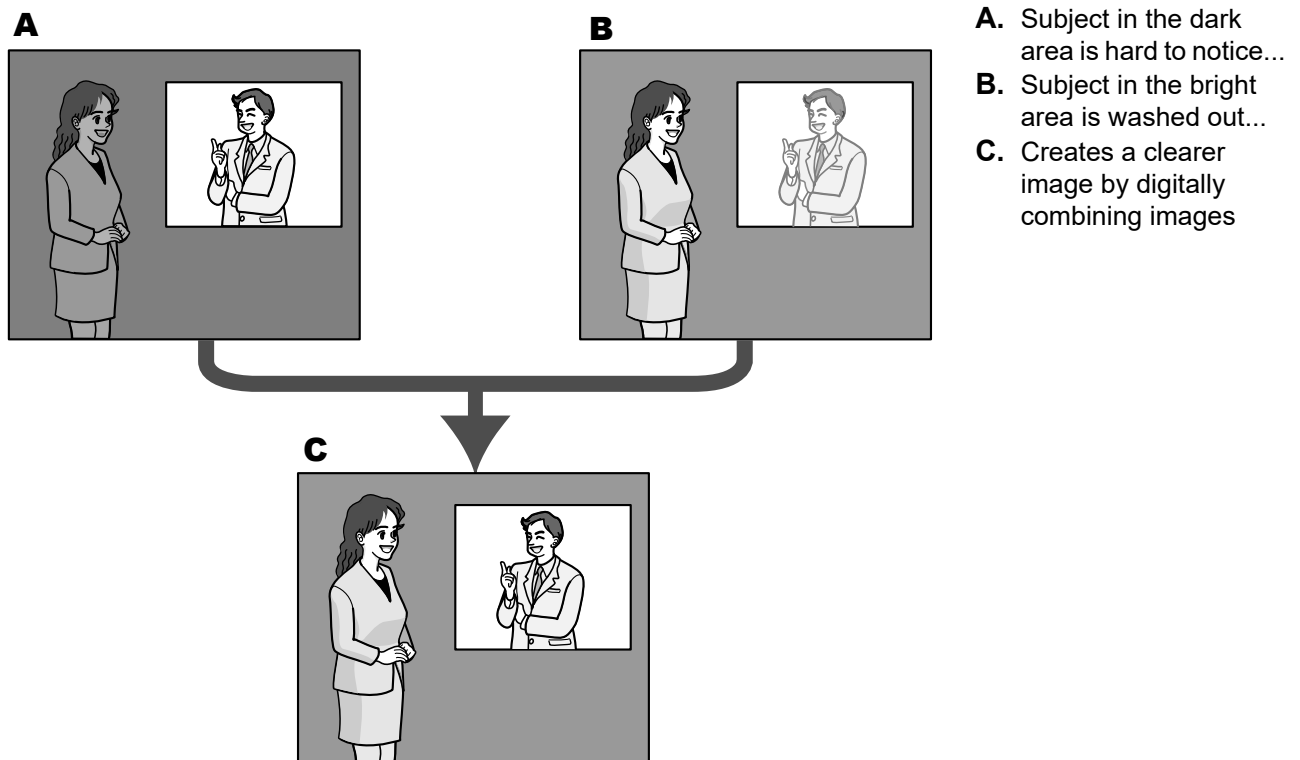

#### [BLC/ HLC]

Select from the following. When “On” is selected for “Super Dynamic(SD)” or when “On” is selected for “Intelligent Auto”, this setting is not available.

- **Back light compensation (BLC):** Activates the back light compensation (BLC) function.
- **High light compensation(HLC):** Activates the high light compensation (HLC) function. The high light compensation function limits the over exposure of subjects caused bright light (such as light from headlights of cars) at night.
- **Off:** Deactivates the back light compensation function and high light compensation function.
- **Default:** Off

### [BLC level]

Adjust the BLC level.

If you move the slider in the “+” direction, the effect of back light compensation will increase.

If you move the slider in the “-” direction, the effect of back light compensation will decrease.

Click the [Reset] button to reset to the default setting.

- **Default:** 16

### [HLC level]

Adjust the high light compensation level.

If you move the slider in the “+” direction, the effect of high light compensation (HLC) will increase.

If you move the slider in the “-” direction, the effect of high light compensation (HLC) will decrease.

Click the [Reset] button to reset to the default setting.

- **Default:** 16

### [Mask area]

When mask area is set, the selected area is masked and you can adjust brightness. When “On” is selected for “Super Dynamic(SD)”, this setting is not available.

Refer to Page 121 for information on how to set the mask area.

## Light control mode

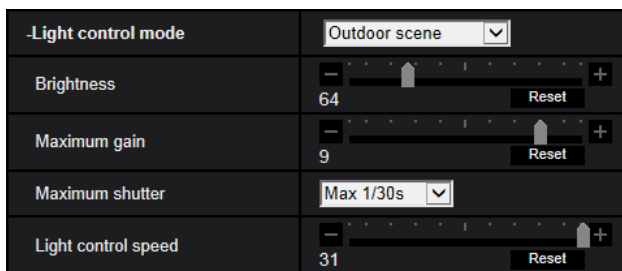

### [Light control mode]

Select the light control mode from the following.

- **Outdoor scene:** Depending on the brightness level (illuminance), the iris will automatically be controlled together with the shutter speed adjustment to control light. When shooting a bright subject such as outdoor, etc., select this parameter. Be aware that flicker may occur when a subject is under fluorescent lighting.
- **Indoor scene (50 Hz) / Indoor scene (60 Hz):** The shutter speed will automatically be adjusted to prevent flicker caused by fluorescent light. Select 50 Hz or 60 Hz corresponding to the location where the camera is in use.
- **Fix shutter:**
  - When “2 mega pixel [16:9](60fps mode)” or “1.3 mega pixel [16:9](60fps mode)” is selected for “Image capture mode”:  
1/60 Fix, 1/100 Fix, 1/120 Fix, 1/250 Fix, 1/500 Fix, 1/1000 Fix, 1/2000 Fix, 1/4000 Fix, 1/10000 Fix
  - When “2 mega pixel [16:9](30fps mode)”, “1.3 mega pixel [16:9](30fps mode)”, “3 mega pixel [4:3](30fps mode)”, or “1.3 mega pixel [4:3](30fps mode)” is selected for “Image capture mode”:  
1/30 Fix, 3/120 Fix, 2/100 Fix, 2/120 Fix, 1/100 Fix, 1/120 Fix, 1/250 Fix, 1/500 Fix, 1/1000 Fix, 1/2000 Fix, 1/4000 Fix, 1/10000 Fix
- **Default:** Outdoor scene

### Note

- When a faster shutter speed is selected (up to 1/10000), it is possible to capture a fast moving object with less blur.

- When a faster shutter speed is selected, the sensitivity will become lower.
- When “On” is selected for “Super Dynamic(SD)”, “Fix shutter” is not available. To configure “Fix shutter”, set “Super Dynamic(SD)” to “Off”.

### [Brightness]

Adjust the brightness.

If you move the slider in the “+” direction, the image will become brighter.

If you move the slider in the “-” direction, the image will become darker.

Click the [Reset] button to reset to the default brightness setting.

- **Default:** 64

### [Maximum gain]

Adjusts the maximum gain. When the luminance of the subject becomes darker, gain will be automatically increased and screen will become brighter. If you increase the gain, the noise may also increase.

If you move the slider in the “+” direction, the maximum gain will increase.

If you move the slider in the “-” direction, the maximum gain will decrease.

Click the [Reset] button to reset to the default setting.

- **Default:** 9

### [Maximum shutter]

The maximum shutter time adjusts the storage time of the sensor. The following are available for the recording duration.

- When “2 mega pixel [16:9](60fps mode)” or “1.3 mega pixel [16:9](60fps mode)” is selected for “Image capture mode”:  
Max.1/4000s, Max.1/2000s, Max.1/1000s, Max.1/500s, Max.1/250s, Max.1/120s, Max.1/100s, Max.2/120s, Max.1/30s, Max.2/30s, Max.4/30s, Max.6/30s, Max.10/30s, Max.16/30s
- When “2 mega pixel [16:9](30fps mode)”, “1.3 mega pixel [16:9](30fps mode)”, “3 mega pixel [4:3](30fps mode)”, or “1.3 mega pixel [4:3](30fps mode)” is selected for “Image capture mode”:  
Max.1/4000s, Max.1/2000s, Max.1/1000s, Max.1/500s, Max.1/250s, Max.1/120s, Max.1/100s, Max.2/120s, Max.2/100s, Max.3/120s, Max.1/30s, Max.2/30s, Max.4/30s, Max.6/30s, Max.10/30s, Max.16/30s
- **Default:** Max.1/30s

### Note

- When “On” is selected for “Super Dynamic(SD)”, “Max.1/2000s” and “Max.1/4000s” are not available.
- When “0” is selected for “Maximum gain”, “Max.2/30s” or higher is not available in 30fps mode and “Max.1/30s” or higher is not available in 60fps mode.

### [Light control speed]

Adjust the light control speed.

If you move the slider in the “+” direction, the light control speed will increase.

If you move the slider in the “-” direction, the light control speed will decrease.

Click the [Reset] button to reset to the default setting.

- **Default:** 31

## Day & Night(IR)

-Day & Night(IR)	Auto1(Normal) ▾
Level	<input type="radio"/> High <input checked="" type="radio"/> Low
Dwell time	10s ▾

### [Day & Night(IR)]

Select switching between the color mode and the black & white mode from the following.

- **Off:** The color mode is selected.
- **On:** Always captured as black & white images.
- **Auto1(Normal):** The camera automatically switches between the color mode and the black & white mode in accordance with the picture brightness (luminance).
- **Auto2(IR Light):** The camera automatically switches between the color mode and the black & white mode in accordance with the picture brightness (luminance). Suitable when using near-infrared lighting at night.
- **Auto3(SCC):** Suitable to keep the color mode even under darker light condition. The Super Chroma Compensation (SCC) function retains the color mode even with dim lighting.
- **Default:** Auto1(Normal)

### Super Chrome Compensation (SCC) function

This function achieves faithful color images using the proprietary color compensation technology that reproduce images even under low illumination where it is usually difficult to capture objects faithfully.

#### Note

- Since the color compensation technology is used for “Auto3(Super Chrome Compensation(SCC))”, some colors may look different from the actual objects depending on the light condition (such as when infrared lights are used).
- The operating sound might be heard when changing to black-and-white mode, however it does not indicate any malfunction.

### [Level]

Select the threshold illuminance level (brightness) to switch between the color mode and the black & white mode. The descriptions about the following threshold illuminance levels are given when “Off” is selected for “Super Dynamic(SD)”.

- **High:** Switches from the color mode to the black & white mode when the ambient brightness (illuminance) of the camera is approx. 2 lx or less.
- **Low:** Switches from the color mode to the black & white mode when the ambient brightness (illuminance) of the camera is approx. 1 lx or less.
- **Default:** High

#### Note

- When a low value is selected for “Maximum gain”, it may be difficult to switch modes depending on the environment.

### [Dwell time]

Select a wait time for switching between the color mode and the black & white mode from the following.

2s/ 10s/ 30s/ 1min

- **Default:** 10s

## White balance

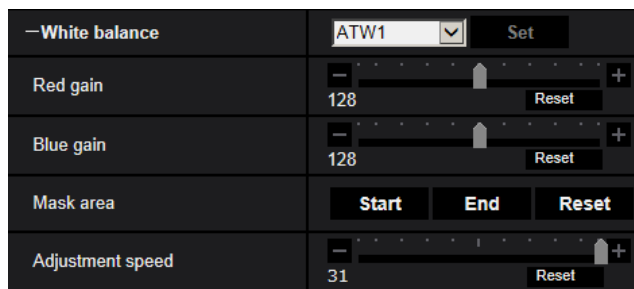

### [White balance]

Select a method of white balance adjustment from the following.  
White color can be adjusted by “Red gain” and “Blue gain”.

- **ATW1:** Selects the automatic tracing white balance mode. The camera will constantly check the color temperature of the light source and adjust the white balance automatically. Operating color temperature range is approx. 2,700 K to 6,000 K.
- **ATW2:** Selects the automatic tracing white balance mode under a sodium lamp. The camera will adjust the white balance automatically under a sodium lamp. Operating color temperature range is approx. 2,000 K to 6,000 K.
- **AWC:** Selects the automatic white balance control mode. This adjustment is suitable for a location where a light source is stable. Operating color temperature range is approx. 2,000 K to 10,000 K.
- **Default:** ATW1

### Note

- Under the following conditions, color may not be faithfully processed. In these cases, select “AWC”.
  - When shooting a subject whose major part is a thick color
  - When shooting blue sky or sun at sunset
  - When shooting a subject whose luminance is too low
- When “AWC” is selected, click the [Set] button.

### [Red gain]

Adjust the red color of images.

When the slider is moved in the “+” direction, the red color will become thicker. When the slider is moved in the “-” direction, the red color will be thinner. Click the [Reset] button to reset the color to the default.

- **Default:** 128

### [Blue gain]

Adjust the blue color of images.

When the slider is moved in the “+” direction, the blue color will become thicker. When the slider is moved in the “-” direction, the blue color will be thinner. Click the [Reset] button to reset the color to the default.

- **Default:** 128

### [Mask area]

If you set the mask area, you can adjust the white balance after masking the set area.  
Refer to Page 121 for information about how to configure the mask area.

### [Adjustment speed]

Adjust the white balance adjustment speed.

If you move the slider in the “+” direction, the white balance adjustment speed will increase. If you move the slider in the “-” direction, the white balance adjustment speed will decrease. If you click the [Reset] button, the slider position and white balance adjustment speed will be reset to default.

- **Default:** 31

## Intelligent Auto

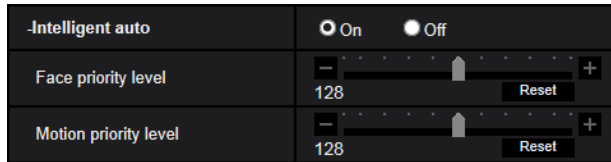

### [Intelligent Auto]

Select On/Off to determine whether or not to activate the “Intelligent Auto” function.

“Intelligent Auto” can detect conditions (back lighting, outdoor, night time, etc.), people's faces, and moving objects, and then automatically adjust the camera's aperture, gain, shutter speed, and contrast in order to display people's faces and moving objects more clearly.

- **Default:** On

### [Face priority level]

Adjusts the face priority level when “Intelligent Auto” is activated.

If you move the slider in the “+” direction, adjusts to improve the visibility of faces.

If you move the slider in the “-” direction, adjusts the entire image so that is well-balanced.

Click the [Reset] button to reset to the default setting.

- **Default:** 128

### [Motion priority level]

Adjusts the motion priority level when “Intelligent Auto” is activated.

If you move the slider in the “+” direction, it becomes difficult for the moving subjects to blur, but the noise of dark subjects increases.

If you move the slider in the “-” direction, it becomes easier for the moving subjects to blur, but the noise of dark subjects decreases.

Click the [Reset] button to reset to the default setting.

- **Default:** 128

## Detailed setting

-Detailed setting	
Auto contrast adjust	<input type="radio"/> On <input checked="" type="radio"/> Off(Manual)
Contrast level	128  + - [Reset]
Adaptive black stretch	128  + - [Reset]
Adaptive highlight stretch	128  + - [Reset]
Fog compensation	<input checked="" type="radio"/> On <input type="radio"/> Off
Level	4  + - [Reset]
Chroma gain level	128  + - [Reset]
Hue level	128  + - [Reset]
Aperture level	16  + - [Reset]
Pedestal level	128  + - [Reset]
DNR	128  + - [Reset]

### [Auto contrast adjust]

Select On/Off(Manual) to determine whether or not to activate the auto contrast adjust function.

**On:** Activates the auto contrast adjust function.

**Off:** Stops the auto contrast adjust function.

- **Default:** On

### Note

- When “On” is selected for “Intelligent Auto”, this setting is not available.

### [Contrast level]

Adjust the contrast level.

If you move the slider in the “+” direction, the contrast of the image will increase.

If you move the slider in the “-” direction, the contrast of the image will decrease.

Click the [Reset] button to reset to the default setting.

- **Default:** 128

### [Adaptive black stretch]

Adjust the brightness of the dark parts of the image.

If you move the slider in the “+” direction, the contrast of the bright part of the image will increase.

If you move the slider in the “-” direction, the contrast of the bright part of the image will decrease.

Click the [Reset] button to reset to the default setting.

- **Default:** 128

## **IMPORTANT**

- The “adaptive black stretch” settings may cause the noise in the darker parts to increase, and the parts around borders between the darker parts and the brighter parts may become darker/brighter than the other darker/brighter parts.

### [Adaptive highlight stretch]

Adjust the brightness of the bright parts of the image.

If you move the slider in the “+” direction, the dark parts of the image will become brighter.

If you move the slider in the “-” direction, the bright parts of the image will become darker.

Click the [Reset] button to reset to the default setting.

- **Default:** 128

### [Fog compensation]

Select “On” or “Off” to determine whether or not to activate the fog compensation function. When “On” is selected for “Auto contrast adjust”, or when “On” is selected for “Intelligent Auto”, this setting is not available. The fog compensation function can make dim images that have been affected by fog or other conditions clearer using digital image processing.

- **On:** Activates the fog compensation function.
- **Off:** Stops the fog compensation function.
- **Default:** Off

### [Level]

Adjust the fog compensation level.

The level of fog compensation will increase when the slider is moved in the “+” direction, and decrease when the slider is moved in the “-” direction. Click the [Reset] button to reset to the default setting.

- **Default:** 4

### [Chroma gain level]

Adjusts the chroma level (color density).

If you move the slider in the “+” direction, the colors will become loud and vivid. If you move the slider in the “-” direction, the colors will become subdued. Click the [Reset] button to reset the color to the default.

- **Default:** 128

### [Hue level]

Adjust the hue level of images.

If you move the slider in the “+” direction, the redness of skin color will increase, and the blueness of sky color will decrease.

If you move the slider in the “-” direction, the redness of skin color will decrease, and the blueness of sky color will increase.

Click the [Reset] button to reset to the default setting.

- **Default:** 128

### [Aperture level]

Adjust the aperture level (outline compensation).

If you move the slider in the “+” direction, the outline of the image will become sharper, and if you move it in the “-” direction, the outline of the image will become softer. Click the [Reset] button to reset the color to the default.

- **Default:** 16

### [Pedestal level]

Adjust the black level of images by moving the slider.

When the slider is moved to the “+” direction, images will become brighter. When the slider is moved to the “-” direction, images will be darker. Click the [Reset] button to reset the color to the default.

- **Default:** 128

### [DNR]

The digital noise reduction function reduces noise automatically under the condition of low illuminance.



If you move the slider in the “+” direction, the noise reduction effect is strengthened. There may be many afterimages.

If you move the slider in the “-” direction, the noise reduction effect is weakened. There are fewer afterimages. Click the [Reset] button to reset to the default setting.

- **Default:** 128

## Scene registration

### [Scene file]

The combination of settings used to adjust image quality can be saved as a scene file. The scene file can be selected here.

Registered scene files can be configured in the “Schedule” page (→page 232). If the timing of when images are viewed greatly affects the area where images are viewed, registering scene files to the schedule can let you match a combination of settings to different times of day in order to view images in the best conditions.

### [Scene file title]

The scene file name (up to 10 characters) displayed in “Scene file” can be changed. Only file names displayed in “1:”, “2:”, “3:”, and “4:” can be changed.

- **Unavailable characters:** " &

### [Load] button

Loads the setting data selected in “Scene file” and changes the current image accordingly.

### [Register] button

The combination of settings used to adjust image quality that are currently displayed can be registered to the scene file displayed in “Scene file”.

## 2.5.5.2 Set mask areas

This explains how to mask an area of the image and adjust brightness. When setting the mask area, set “Super Dynamic(SD)” to “Off”.

## 2 Settings

1. Display the “Image adjust” setup menu. (→page 105)

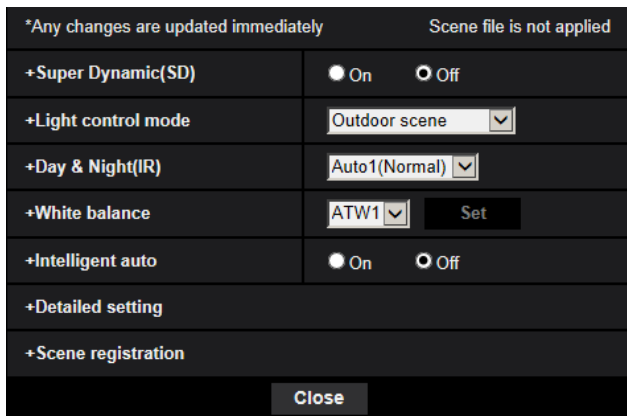

2. Click “+” on the left of “Super Dynamic(SD)” to display the detailed SD menu.



3. Click the [Start] button of “Mask area”.  
→ Borders will appear and the image displayed on the [Image/Position] tab will be divided into 63 (7x9).

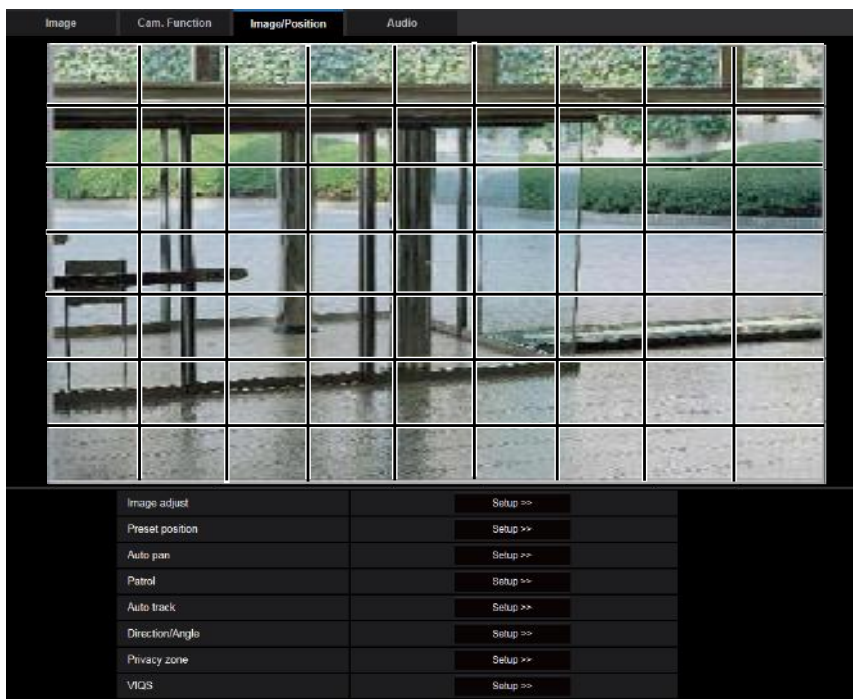

4. Click the divided areas to be masked.

→ The clicked areas will be masked and will become white. To cancel masking, click the area again.

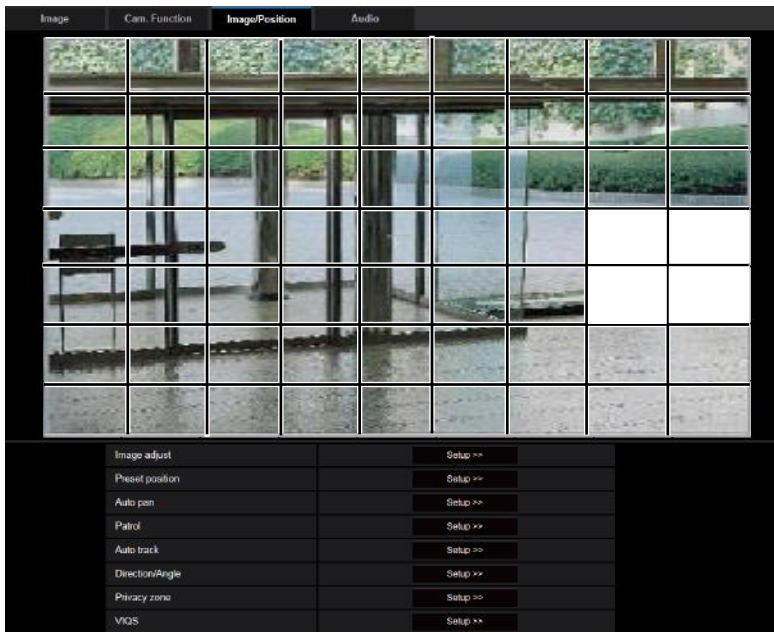

5. Click the [End] button after completing masking areas.

→ The borders on the image displayed on the [Image/Position] tab will disappear.

### IMPORTANT

- The mask area may move out of alignment when “Image capture mode” of the [Image] tab is changed. Make sure to check the mask area after changing the “Image capture mode” setting.
- The mask area may move out of alignment when “HD Extra optical zoom” is configured after the mask area is set. Make sure to check the mask area after changing the “Image capture mode” setting.

### Note

- When the [Reset] button is clicked, masking for all the masked areas will be canceled.

## 2.5.5.3 Configure the settings relating to the preset positions (“Preset position” setup menu)

Click the [Setup>>] button of “Preset position” on the [Image/Position] tab of the “Image/Audio” page.

It is possible to register, edit and delete the preset positions on this page.

When the focus, brightness, zoom factor are adjusted, the adjustment will be applied immediately to the currently displayed image on the [Image/Position] tab.

## 2 Settings

Preset No	1::None
Position No	1
Preset ID	<input checked="" type="radio"/> On <input type="radio"/> Off
Preset ID (0 - 9,A - Z)	
Auto focus	<input checked="" type="radio"/> Auto <input type="radio"/> Off
Dwell time	10s
<b>Set</b> <b>Delete</b>	
*Any changes are updated immediately	
Super Dynamic	<input checked="" type="radio"/> On <input type="radio"/> Off
Level	28 <b>Reset</b>
BLC/ HLC	Off
BLC level	16 <b>Reset</b>
HLC level	16 <b>Reset</b>
Mask area	<b>Start</b> <b>End</b> <b>Reset</b>
<b>Zoom</b> <input type="radio"/> <input checked="" type="radio"/> <input type="radio"/>	
<b>Focus</b> <b>Auto</b> <b>Near</b> <b>Far</b>	
<b>Brightness</b> - <b>Normal</b> +	
<b>Close</b>	

### **IMPORTANT**

- During the preset position setting, do not change other settings. The image may not be properly displayed.
- With the digital zoom factor, the setting of the preset positions will become unavailable.
- Preset position can be set to a maximum of 256 positions.

### **Note**

- Depending on the environment (such as when the temperature is below 5° C (41 °F), for example), the moving speed of the camera to the preset position may become slower.

## Position No

### [Preset ID]

Select "On" or "Off" to determine whether to enable or disable the preset ID display. This function can be applied to each preset position.

- **On:** Displays the preset ID.
- **Off:** Does not display the preset ID.
- **Default:** Off

### IMPORTANT

- When "Preset ID (0-9,A-Z)" or "Preset ID" is configured, it is necessary to click the [Set] button to apply them.

### Note

- When "On" is selected, the entered preset ID will be displayed at the position selected for "OSD" on the [Basic] tab of the "Basic" page. (→Page 73)

### [Preset ID (0-9,A-Z)]

Enter the preset ID to be displayed on images. This function can be applied to each preset position.

- **Available number of characters:** 0 - 20 characters
- **Available characters:** 0-9, A-Z, a-z and the following marks.  
! " # \$ % & ' ( ) \* + , - . / : ; = ?
- **Default:** None (blank)

### Note

- The entered preset ID will be displayed next to the preset position number on the pull-down menu. When "On" is selected for "Preset ID", the preset ID will be displayed on images.

### [Auto focus]

Select "Auto" or "Off" to determine whether to enable or disable the auto focus function after the camera has moved to a preset position. This function can be applied to each preset position.

- **Auto:** The auto focus function will be activated after moving to a preset position.
- **Off:** Does not activate the auto focus function after moving to a preset position.
- **Default:** Off

### Note

- When the preset position is set to shoot the following objects, it is recommended to select "Off", and adjust the focus before registering the preset positions.
  - An object whose contrast is low
  - An object whose depth never changes
  - An object with high luminance such as a spotlight

### [Dwell time]

Select a dwell time (duration the camera stops for at each preset position) for the preset sequence operation.  
Off/ 5s/ 10s/ 15s/ 20s/ 25s/ 30s

- **Default:** 10s

### Note

- When the preset sequence operates, preset positions that are set to "Off" will not be moved to and the sequence will move to the next position.
- Depending on the set dwell time, moving to the next preset position may start during auto focus operation.

- Using the preset sequence function for a long period of time wears the driving parts, and the replacement interval of those parts may be shortened. Refer to the Important Information in the supplied CD-ROM for the consumable parts.

### [Super Dynamic(SD)]

Select “On” or “Off” to determine whether to turn on or off the Super Dynamic function. This function can be applied to each preset position.

This is not available when “Image capture mode” is set to “2 mega pixel [16:9](60fps mode)” or “1.3 mega pixel [16:9](60fps mode)”.

Refer to the description “Super Dynamic function” (→Page 113) about the super dynamic function.

- **On:** The Super Dynamic function will work.
- **Off:** The Super Dynamic function will not work.
- **Default:** Off

### [Level]

Adjust the super dynamic (SD) level.

If you move the slider in the “+” direction, a subject with high contrast can be captured without over exposure or under exposure.

If you move the slider in the “-” direction, the parts with medium brightness can be captured with rich gradation. Click the [Reset] button to reset to the default setting.

- **Default:** 28

### [BLC/ HLC]

Select from the following. When “On” is selected for “Super Dynamic(SD)” or when “On” is selected for “Intelligent Auto”, this setting is not available.

- **Back light compensation (BLC):** Activates the back light compensation (BLC) function.
- **High light compensation(HLC):** Activates the high light compensation (HLC) function. The high light compensation function limits the over exposure of subjects caused bright light (such as light from headlights of cars) at night.
- **Off:** Deactivates the back light compensation function and high light compensation function.
- **Default:** Off

### [BLC level]

Adjust the BLC level.

If you move the slider in the “+” direction, the effect of back light compensation will increase.

If you move the slider in the “-” direction, the effect of back light compensation will decrease.

Click the [Reset] button to reset to the default setting.

- **Default:** 16

### [HLC level]

Adjust the high light compensation level.

If you move the slider in the “+” direction, the effect of high light compensation (HLC) will increase.

If you move the slider in the “-” direction, the effect of high light compensation (HLC) will decrease.

Click the [Reset] button to reset to the default setting.

- **Default:** 16

### [Mask area]

When mask area is set, the selected area is masked and you can adjust brightness.

When “On” is selected for “Super Dynamic(SD)”, this setting is not available.

Refer to Page 121 for information about how to configure the mask area.

### [Zoom] buttons, [Focus] buttons, Control pad/buttons, [Brightness] buttons

Refer to Page 15 for descriptions of how to operate these buttons/pad.

**[Set] button**

Registers the preset positions.

**[Delete] button**

Deletes the preset position specified by the position number.

**[Close] button**

Click this button to close the “Preset position” setup menu.

## Register the preset positions

1. Select a preset position number.
  - The selected preset position number will be displayed in the “Position No” area.  
When the selected number has already been registered, the camera will move to the selected preset position.
2. Move the camera to the desired direction.
3. To display the preset ID on the “Live” page, select “On” for “Preset ID” and enter the desired position title to be displayed.
4. The settings for “Auto focus” and “Dwell time” can be configured for each position independently.
5. Click the [Set] button.
6. The settings for each item such as “Super Dynamic” can be configured for each position independently. The settings for “Super Dynamic”, “BLC/ HLC” and “Mask area” are updated immediately.

**Note**

- When registering the preset position, the camera direction may move slightly.
- When a setting other than “Scene file is not applied” is selected for “Scene file” of “Image adjust”, “Super”, “BLC/ HLC”, and “Mask area” cannot be used.

### 2.5.5.4 Configure the settings relating to the auto pan function (“Auto pan” setup menu)

Click the [Setup>>] button of “Auto pan” on the [Image/Position] tab of the “Image/Audio” page (→Page 110). The settings relating to the auto pan function can be configured with the setup menu.

## 2 Settings

### Note

- Using the auto pan function for a long period of time wears the driving parts, and the replacement interval of those parts may be shortened. Refer to the Important Information in the supplied CD-ROM for the consumable parts.



## Position

### [Left end position setup] X6531 X6511 S6131 S6111

Move the camera to the desired point as the left end point of the auto panning using the [Zoom] button, [Focus] button, or control pad/buttons. Then, click the [Set] button. Also, the zoom and focus settings are set simultaneously.

### Note

- Panning, tilting and zooming operations can also be carried out on the [Image/Position] tab.

### [Right end position setup] X6531 X6511 S6131 S6111

Move the camera to the desired point as the right end point of the auto panning using the control pad/buttons. Then, click the [Set] button.

### [Start position] S6530 S6130

Move the camera to the desired point to start the auto panning using the [Zoom] button, [Focus] button, or control pad/buttons. Then, click the [Set] button. Also, the zoom and focus settings are set simultaneously.

### Note

- Panning, tilting and zooming operations can also be carried out on the [Image/Position] tab.

### [End position] S6530 S6130

Move the camera to the desired point to stop the auto panning using the control pad/buttons. Then, click the [Set] button.



## Auto pan

### [Dwell time]

Select a dwell time at the start point and the end point from the following.

0s/ 1s/ 2s/ 3s/ 4s/ 5s/ 10s/ 15s/ 20s/ 25s/ 30s

- **Default:** 5s

### [Speed]

Select a speed for the auto panning from the following.

X6531  X6511  S6131  S6111

1°/s, 2°/s, 3°/s, 4°/s, 5°/s, 7°/s, 10°/s, 13°/s, 18°/s, 24°/s

S6530  S6130

1°/s, 2°/s, 3°/s, 4°/s, 5°/s, 7°/s, 9°/s, 14°/s, 19°/s, 24°/s

- **Default:** 13°/s  X6531  X6511  S6131  S6111

**Default:** 14°/s  S6530  S6130

### IMPORTANT

- When “Auto pan” is set, it is necessary to click the [Set] button to apply them.

### Note

- Even when the zoom factor for the digital zoom is set, the camera will start panning with the following zoom factor or lower:

60x:  X6531  X6511  S6131  S6111

31x:  S6530  S6130

### [Endless panning] X6531 X6511 S6131 S6111

The operations for panning can be set to the following

**Off:** Pan between the left and right end position points.

**On(Clockwise):** Pans clockwise.

**On(Counterclockwise):** Pans counterclockwise.

**Default:** Off

### [Zoom] buttons, [Focus] buttons, [Brightness] buttons, Control pad/buttons and [Go] button

Refer to Page 15 for descriptions of how to operate these buttons/pad.

### [Close] button

Click this button to close the “Auto pan” setup menu.

## 2.5.5.5 Configure the settings relating to patrol (“Patrol” setup menu)

Click the [Setup>>] button of “Patrol” on the [Image/Position] tab of the “Image/Audio” page (→Page 110).

Here, the information related to patrol is set.

The patrol function can be configured to learn pan, tilt, zoom, and focus settings and operations, and then use these learned settings and operations to operate the camera.

### Note

- Using the patrol function for a long period of time wears the driving parts, and the replacement interval of those parts may be shortened. Refer to the Important Information in the supplied CD-ROM for the consumable parts.

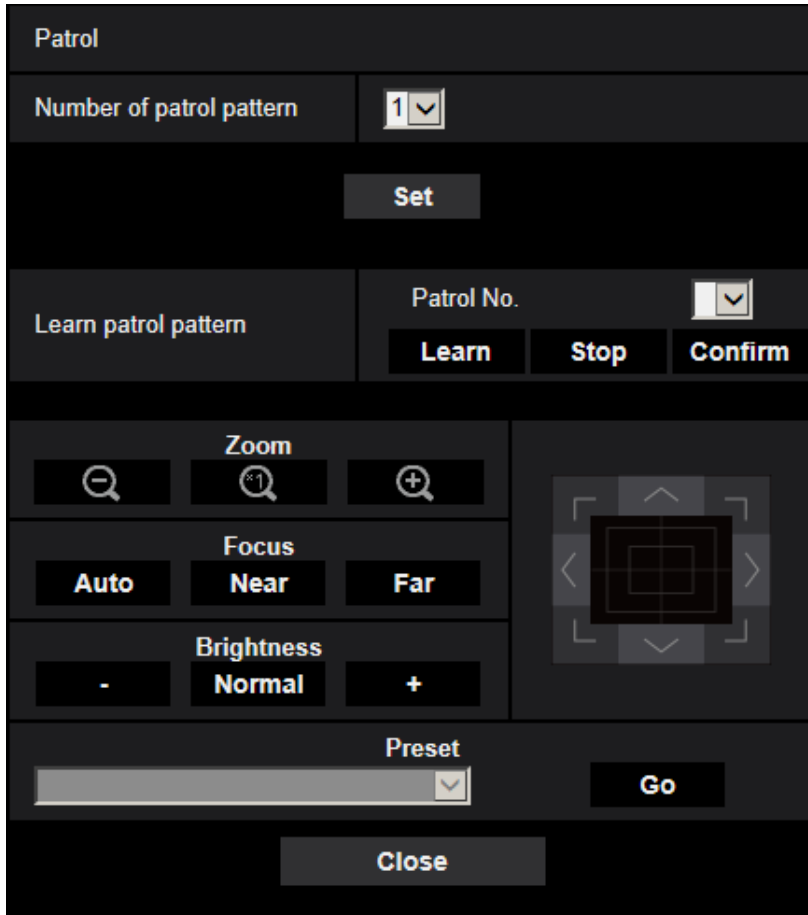

## Patrol setting

### [Number of patrol pattern]

Select the patrol pattern number. The length of patrol patterns that can be learned differs depending on the pattern number.

- 1:** 2 minutes of operations can be learned for Patrol 1.
- 2:** 1 minute of operations can be learned for both Patrol 1 and Patrol 2.
- 4:** 30 seconds of operations can be learned each for Patrol 1, Patrol 2, Patrol 3, and Patrol 4.
- Default:** 1

### Note

- When the number of control patterns is changed, the learned patrol operations are deleted.

### [Learn patrol pattern]

Click [▼] of "Patrol No." and select a patrol number (1-4) from the pull-down menu. An asterisk (\*) next to the patrol number indicates that the patrol operation has already been learned for the patrol number.

With the patrol number selected, click the [Learn] button to start learning the camera operations. During learning, "LEARNING (\*\*S)" is displayed on the screen. "\*\*S" is the length of possible learning time remaining.

Click the [Stop] button to stop learning and replaying camera operations. When the remaining time is zero seconds (0S), operations are automatically stopped.

With the patrol number selected, click the [Confirm] button to replay the learned camera operations.

#### **Note**

- The following are the camera operations that can be learned.
  - Start position operations  
pan/tilt/zoom/focus position
  - Camera operations  
pan/tilt/zoom/focus position/moving the preset position
- The auto focus function cannot be used when performing patrol operations. As a characteristic of zoom lenses, when images are zoomed up from the “Wide” side, they may become blurred. When learning zoom operations, starting from the “Tele” side will reduce blurring.

#### **[Zoom] buttons, [Focus] buttons, [Brightness] buttons, Control pad/buttons and [Go] button**

Refer to Page 15 for descriptions of how to operate these buttons/pad.

#### **[Close] button**

Click this button to close the “Patrol” setup menu.

### **2.5.5.6 Configure the settings relating to auto track (“Auto track” setup menu)**

Click the [Setup>>] button of “Auto track” on the [Image/Position] tab of the “Image/Audio” page (→Page 110).

Here, the information related to the auto track setting is set.

#### **Note**

- The auto-track setup is not available under the following conditions:
  - When “Image capture mode” is set to “2 mega pixel [16:9](60fps mode)” or “1.3 mega pixel [16:9] (60fps mode)”
  - When “On” is selected for “Stabilizer”
  - When other than “Off” is selected for “Smart Facial Coding” of “Smart Coding” for “Stream(1)”
  - When “Maximum shutter” of “Image adjust” - “Light control mode” is the following:  
Max.2/30s/ Max.4/30s/ Max.6/30s/ Max.10/30s/ Max.16/30s
- Using the auto track function for a long period of time wears the driving parts, and the replacement interval of those parts may be shortened. Refer to the Important Information in the supplied CD-ROM for the consumable parts.

## 2 Settings

The auto track function can be used to detect movement in a predetermined alarm area and automatically track and capture images of the subject detected in that area.

Auto track setting	
Camera height	2.5m(8.5ft) <input type="button" value="Auto"/>
Auto track alarm	Off
Alarm wait time	10s
Auto track data in video stream	Off
<input type="button" value="Set"/>	
Advanced setting	
Zoom with auto track	<input type="radio"/> On <input checked="" type="radio"/> Off
Object size	Small(1/4 of the image)
Sensitivity	Middle
Auto track duration time	Off(Unlimited)
Lost object search	On(w/zoom-out)
<input type="button" value="Set"/>	
Alarm area	
Area select	Area No. <input type="button" value="v"/>
Area No. notification	<a href="#">Panasonic alarm protocol notification &gt;&gt;</a>
* When notifying alarm area numbers by the Panasonic alarm protocol, set "Additional alarm area data(VMD/Auto track)" to "On".	
<input type="button" value="Set"/> <input type="button" value="Delete"/> <input type="button" value="Cancel"/>	
Detection mask area	
Area select	Area No. <input type="button" value="v"/>
<input type="button" value="Set"/> <input type="button" value="Delete"/> <input type="button" value="Cancel"/>	
<b>Zoom</b>	
<input type="button" value="⊖"/> <input type="button" value="⊕"/>	
<b>Focus</b>	
<input type="button" value="Auto"/> <input type="button" value="Near"/> <input type="button" value="Far"/>	
<b>Brightness</b>	
<input type="button" value="-"/> <input type="button" value="Normal"/> <input type="button" value="+"/> 	
<b>Preset</b>	
<input type="button" value="v"/> <input type="button" value="Go"/>	
<input type="button" value="Close"/>	

## Auto track setting

### [Camera height]

Select the height that the camera is installed to from the following.

2.5m(8.5ft)/2.75m(9.0ft)/3.0m(10.0ft)/3.25m(11.0ft)/3.5m(11.5ft)/3.75m(12.5ft)/4.0m(13.5ft)/4.25m(14.0ft)/  
4.5m(15.0ft)/4.75m(16.0ft)/5.0m(16.5ft)/5.5m(18.5ft)/6.0m(20.0ft)/6.5m(21.5ft)/7.0m(23.5ft)/7.5m(25.0ft)/  
8.0m(26.5ft)/8.5m(28.5ft)/9.0m(30.0ft)/9.5m(31.5ft)/10.0m(33.5ft)/12.0m(40.0ft)/14.0m(46.5ft)/16.0m(53.5ft)/  
18.0m(60.0ft)/20.0m(66.5ft)/22.0m(73.5ft)/24.0m(80.0ft)/26.0m(86.5ft)/28.0m(93.5ft)/30.0m(100.0ft)

**Default:** 2.5m(8.5ft)

### Note

- The “Camera height” setting is the tracking targets and cameras height (H1: 2.5m(8.5ft) - 30.0m(100.0ft)).
- The camera height can be measured automatically with the [Auto] button. However, if there is any obstacle right under the camera or the auto-focus is not possible, manually set the “Camera height”.

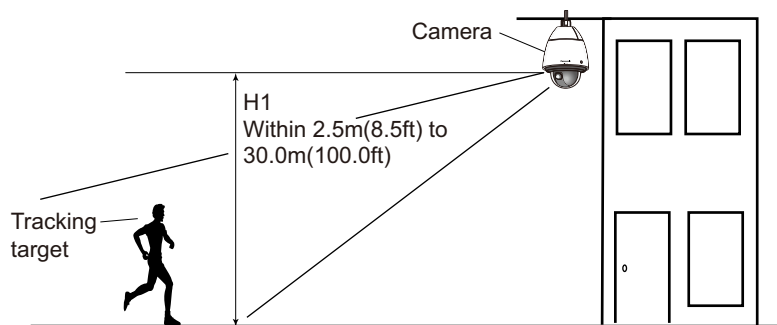

### IMPORTANT

- Enter the height for “Camera height” accurately. The detection and tracking capabilities are greatly reduced if the height setting is incorrect.

### [Auto track alarm]

Select an alarm to be used when auto tracking from the following.

**Off:** An alarm is not outputted.

**On(Immediate):** Alarms are continuously outputted during auto tracking. (Outputs are made at 5 second intervals.)

**On(After alarm wait time):** Alarms are outputted only once when the auto tracking is continuously performed for a set period.

**On(In preset alarm area):** While tacking, if the tracking target enters the set alarm area, an alarm is outputted once. Refer to Page 135 for information about alarm areas.

**Default:** Off

### [Alarm wait time]

Select a setting time from the following when “Auto track alarm” is set to “On(After alarm wait time)”.

1s/10s/30s/1min/3min/5min

**Default:** 10s

### [Auto track data in video stream]

From the following selections select whether or not to add auto track in the video stream.

**Off:** Auto track data is not added to images.

**On:** Auto track data is added to images, but an outline of the tracking target is not displayed on the “Live” page.

**On with track video display:** Auto track data is added to images and an outline of the tracking target is displayed on the “Live” page.

**Default:** Off

### Advanced setting

#### [Zoom with auto track]

Select the tracking zoom control from the following.

**Off:** Zoom control is not performed.

**On:** Zoom control is performed.

**Default:** On

#### [Object size]

Select an object size from the following.

**Small(1/4 of the image):** The tracking target is enlarged to about 1/4 the size (lengthwise) of the monitor screen.

**Middle(1/2 of the image):** The tracking target is enlarged to about 1/2 the size (lengthwise) of the monitor screen.

**Large(3/4 of the image):** The tracking target is enlarged to about 3/4 the size (lengthwise) of the monitor screen.

**Default:** Small(1/4 of the image)

#### Note

- The sizes described here are only a guide. Depending on the environment conditions and the tracking conditions the displayed size may be different from the expected size.
- Increasing the display size of the tracking target reduces the tracking capabilities.

#### [Sensitivity]

Select the tracking sensitivity from the following.

High/ Middle/ Low

**Default:** Middle

#### Note

- Reducing the sensitivity can help reduce false detections such as when a tree is swaying, but it will also reduce the tracking capabilities. On the other hand, increasing the sensitivity increases the tracking capabilities but also increases false detections. Match the settings according to where the camera is used.

#### [Auto track duration time]

Select the time that tracking will be forced to stop from after it started from the following.

Off(Unlimited)/10s/20s/30s/40s/50s/1min/2min/3min/5min/10min

**Default:** Off(Unlimited)

#### Note

- The camera will stop in the position it is at when the auto track duration time expires. To return to auto mode, set the self return, and after tracking is finished, the self return time is counted and the camera returns to auto mode.

#### [Lost object search]

Select the operations to be performed when the tracking loses the target from the following.

**Off:** Tracking stops at the position that it lost the target.

**On(w/o zoom-out):** If the target is lost, tracking starts looking for new movement and if it finds movement it continues auto tracking.

**On(w/zoom-out):** If the target is lost, the camera zooms out and tracking starts looking for new movement, if it finds movement it continues auto tracking.

**Default:** On(w/zoom-out)

## Alarm area

### [Area select]

Click [▼] of “Area No.” and select an area number (1-4) from the pull-down menu. An asterisk (\*) next to the area number indicates that the area has already been learned. When “On(In preset alarm area)” (when there is an alarm area intrusion) is selected with “Auto track alarm”, the alarm area will become active.

### [Area No. notification]

When “Panasonic alarm protocol notification >>” is clicked, the [Notification] tab of the “Alarm” page will be displayed. (→Page 172)

### Note

- The alarm area cannot be configured separately for each preset position. The configured alarm area is active for all preset areas.

## Detection mask area

### [Area select]

Click [▼] of “Area No.” and select an area number (1-4) from the pull-down menu. An asterisk (\*) next to the area number indicates that the area has already been learned. By setting a mask for shooting areas (the screen) that you do not want to detect movement in, false detections can be reduced.

### Note

- By setting a mask for shooting areas (the screen) that have objects that can cause false detections such as swaying trees, roads (where cars pass through), or level surfaces (areas that cause light reflection), false detections can be reduced.
- Mask areas cannot be configured separately for each preset position. The specified area is active for all the preset positions.

### **IMPORTANT**

- During auto tracking, if the tracking target enters the masked area, tracking will continue unchanged. Note that the mask area will not be active in this situation.

### **[Zoom] buttons, [Focus] buttons, [Brightness] buttons, Control pad/buttons and [Go] button**

Refer to Page 15 for descriptions of how to operate these buttons/pad.

### **[Close] button**

Click this button to close the “Auto track” setup menu.

### **IMPORTANT**

- In the following situations, targets may not be able to be tracked, or false detections may occur.
  - when there is little contrast between the subject and the background
  - when dirt, drip, or splash is on the dome cover of camera
  - when there are large changes to the lighting intensity
  - when there are many moving objects other than the subject
  - when there is a change on the optical axis (in a vertical direction) of the camera
  - when the subject moves directly underneath the camera
  - when there is harsh flickering

## 2 Settings

- when there are reflections from light entering the front glass due to reflections from a window or road, or from a backlight
- when the target is hidden behind a utility pole or other objects
- when the subject passes by other moving objects
- when the target moves too fast or too slow
- when the camera is shaking
- In no event shall we be liable to any consequential inconvenience, or loss or damage, arising out of the settings or results of the auto tracking system.
- We recommend that you use this setting under the following setting conditions to improve the detection accuracy.
  - set the size of the tracking target to over 1/5 of the monitoring screen (lengthwise)
  - set the tilt angle within 20° - 55° (→Page 108)

### Procedure to setup auto track cooperation

If 2 or more cameras that support the auto track function are used, tracking of targets can be coordinated between cameras. (Auto track cooperation setting)

For example, the procedure for getting Camera 2 (IP address: 192.168.0.12) to take over auto tracking from Camera 1 (192.168.0.11) when the tracking target enters into alarm area No.1 during auto tracking as shown below, is explained here.

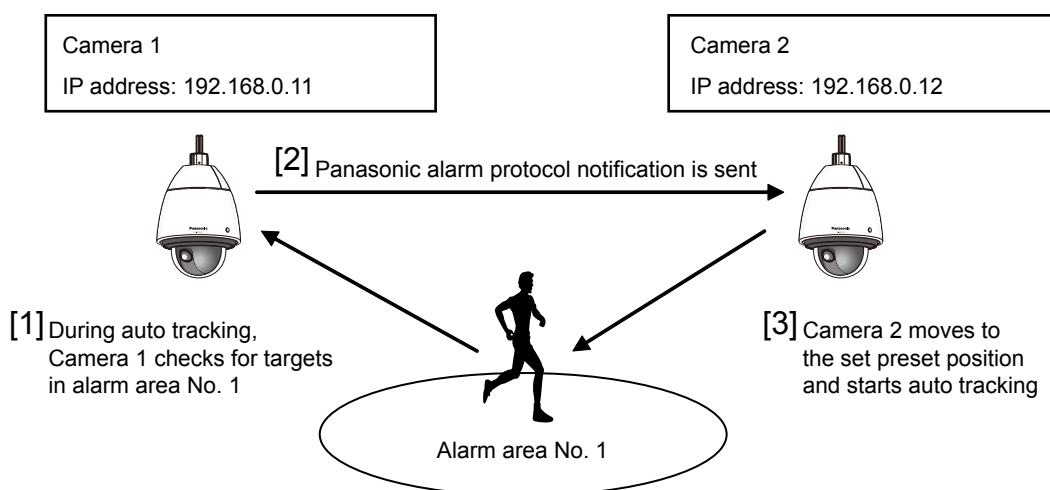

1. Set an alarm area to Camera 1 in the area where you want to perform auto track cooperation.
  - ① Display the "Auto track setting" page.
  - ② With "Auto track alarm" select "On(In preset alarm area)" and click the [Set] button.
  - ③ Select "1" from the "Area No." pull-down menu of "Area select" in "Alarm area".
  - ④ While monitoring images, perform the pan/tilt/zoom, and then set the alarm area.
  - ⑤ Click the [Set] button.
2. On Camera 2, configure the preset position for received notification commands. (Configure the preset position so that alarm area No. 1 enters the screen as configured in step 1.)
  - ① Display the "Preset position" setting page. (→Page 123)
  - ② Select a preset number that you want set from the "Preset" pull-down menu.
  - ③ While monitoring images, perform the pan/tilt/zoom, and then set the preset position.
  - ④ Click the [Set] button.
3. Set Camera 1 (IP address: 192.168.0.11) to notify commands.
  - ① Display the "Notification" screen from the "Alarm" page. (→Page 172)
  - ② From "Panasonic alarm protocol", set "Panasonic alarm protocol" to "On" and click the [Set] button.



- ③ From “Destination of notification”, check the “Alarm” checkbox of “Address 1” (any notification destination address can be selected), and enter 192.168.0.12 in “Destination IP address”.
  - ④ Set “Auto track cooperation” to “On”, and select “1” for the alarm area number.
  - ⑤ Click the [Set] button.
4. Configure the settings of Camera 2 (IP address: 192.168.0.12), which receives notification commands from the other cameras.
    - ① Display the “Alarm” screen from the “Alarm” page. (→Page 152)
    - ② From “Alarm”, set “Command alarm” to “On” and click the [Set] button.
    - ③ Set the “Command alarm” of “Camera action on alarm” to “Preset per sender”, and click “Preset per sender >>”.
    - ④ On the “Preset per sender” setup menu (→Page 159), check the “Auto track cooperation” checkbox of “Sender’s address 1” (any destination address can be used) and enter 192.168.0.11 (Camera 1) for the sender’s address. Then select the preset position set at step 2, click the [Set] button, and then close the page.
    - ⑤ Click the [Set] button.
  5. Auto track cooperation can be used by starting the auto tracking for Camera 1.

**Note**

- During auto tracking, “Stabilizer” and “Smart Facial Coding” will not be operated.

### 2.5.5.7 Configure the settings relating to direction/angle setting (“Direction/Angle setting” setup menu) X6531 X6511 S6131 S6111

Click the [Setup>>] button of “Direction/Angle” on the [Image/Position] tab of the “Image/Audio” page (→Page 110).

Here, the information related to the direction/angle setting is set. The pan/tilt position moves to the position set as north when displaying this page.

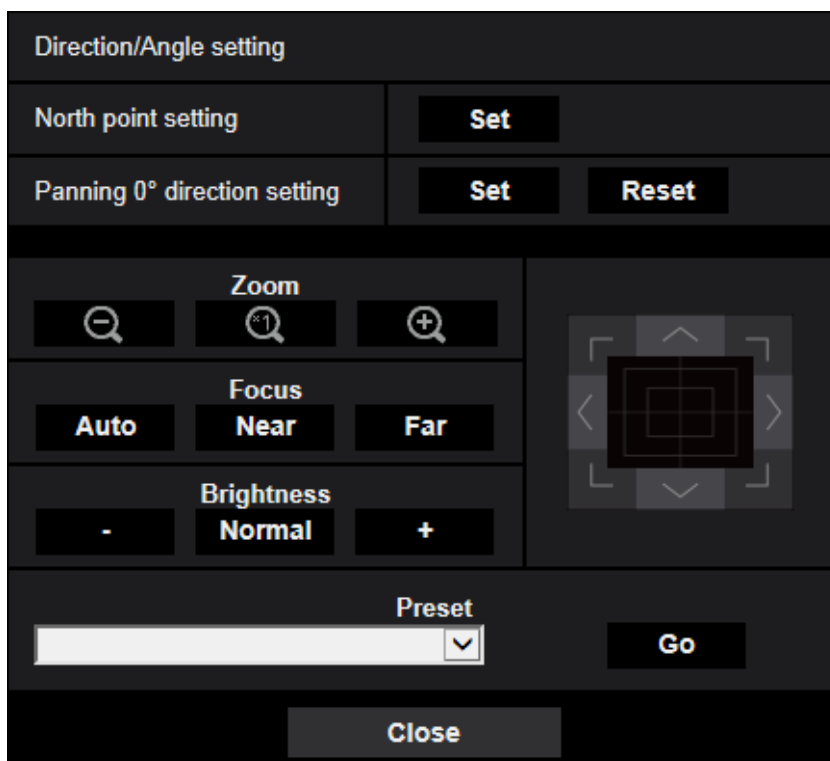

### Direction/Angle setting

#### [North point setting]

If “Direction display” is selected for “Camera position display”, one of the eight directions will be indicated instead of the preset position title when the camera is not at the preset position.

Determine the direction setting by adjusting the displayed panning position to the north (N) indication.

#### [Panning 0° direction setting]

Configure the Panning 0° direction setting. When the [Set] button is clicked after adjusting the angle of view with the control pad/buttons, the current direction of the pan becomes 0°. Click the [Reset] button to reset to the default setting.

#### **Note**

- The tilt 0° angle is not configured.
- Even if the Panning 0° direction is changed, there is no change to the preset positions already configured. The range of the auto pan setting and the actions of the patrol setting already configured are also not changed.

#### **[Zoom] buttons, [Focus] buttons, [Brightness] buttons, Control pad/buttons and [Go] button**

Refer to Page 15 for descriptions of how to operate these buttons/pad.

#### **[Close] button**

Click this button to close the “Direction/Angle setting” setup menu.

### 2.5.5.8 Configure the settings relating to the privacy zone (“Privacy zone” setup menu)

Click the [Advanced setting] button of “Privacy zone” on the [Image/Position] tab of the “Image/Audio” page (→Page 110).

When there is a zone that you do not want to display, set the zone as a privacy zone not to be displayed.

According to the setting of “Number of Privacy zone”, up to 8 or 32 privacy zones can be set (→Page 107).

You can set the areas by dragging the mouse on the screen.

#### **Note**

- The privacy zone function does not work when the camera is in the process of warming-up just after turning on the power, or in the process of refreshing the position.
- Depending on the panning/tilting direction (especially when the tilting degree is 45° - 90°) and the zooming factor, the area set as the privacy zone may become visible. Make sure that each of the set privacy zone is not visible after setting it.

- Reconfigure the privacy zone if the way the camera is fixed is changed.

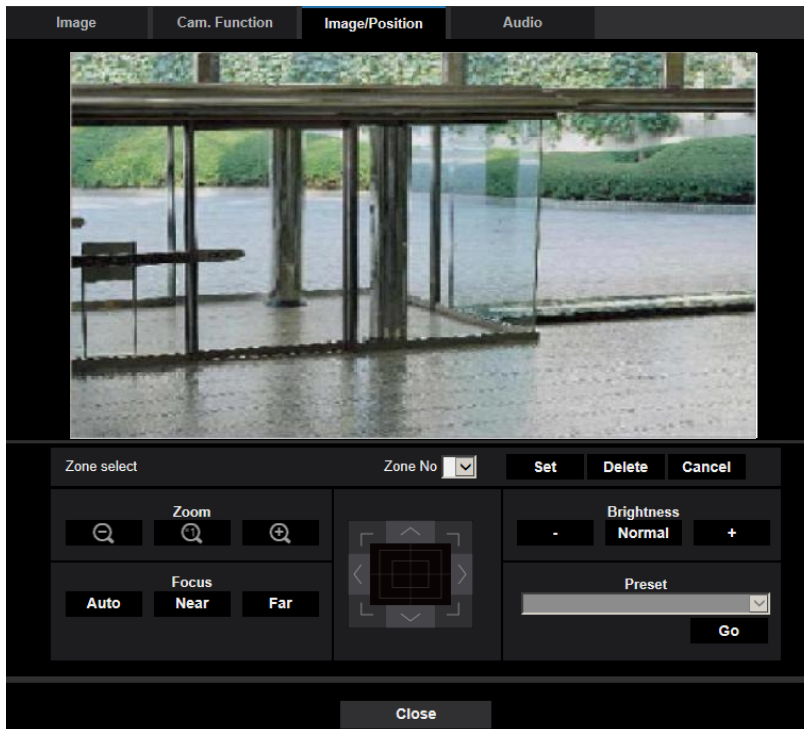

## Zone setting

### [Zone select]

Click [▼] of “Zone No” and select a zone number (1-8 or 1-32) from the pull-down menu.

An asterisk (\*) next to the zone number indicates that the privacy zone has already been set for the number. The privacy zone will be set when an area is designated by dragging the mouse.

Click the [Set] button after determining the position of the camera. In this case, a slightly wider area than was specified will be configured.

To delete the registered zone, click the [Delete] button after designating the desired zone number to be deleted. Click the [Cancel] button to cancel what was set or deleted.

### Note

- Set the privacy zone larger than the size of an object to be hidden.  
To raise the precision of the privacy zone placement especially when the zoom is on the “Wide” side, it is recommended to set the privacy zone with the zoom range between 1x and 3x.
- Panning, tilting and zooming operations can also be carried out on the [Image/Position] tab.
- When selecting “Zone No” after selecting “Filling” for “Privacy zone”, a mask will be displayed in the image display area and will start blinking while changing its color as follows: Dark gray → Clear → Light gray
- Even when “32” is selected for “Number of Privacy zone”, the maximum number of privacy zones that can be displayed on 1 screen at the same time is limited to 8. Depending on the positions of the configured privacy zones and the operation of the camera, the privacy zones may be automatically combined together and displayed as a maximum of 8 privacy zones.
- When the “Number of Privacy zone” setting is changed from “32” to “8”, privacy zones for zones numbers other than 1-8 are not displayed.

### [Zoom] buttons, [Focus] buttons, [Brightness] buttons, Control pad/buttons and [Go] button

Refer to Page 15 for descriptions of how to operate these buttons/pad.

## 2 Settings

---

### **[Close] button**

Click this button to close the “Privacy zone” setup menu.

### 2.5.5.9 Configure the VIQS setting

Click the [Setup>>] button of “VIQS” on the [Image/Position] tab of the “Image/Audio” page. (→Page 110)

The items related to VIQS can be configured with this menu.

VIQS is an abbreviation of Variable Image Quality on Specified area and is a feature that enables you to enhance the image quality of specified areas in images.

It is possible to enhance the image quality of the specified range within a shooting area (image).

It is also possible to moderate the image data size by lowering the image quality of other areas.

The VIQS setting is available only for H.265 and H.264 images.

VIQS can be set to preset position numbers 1 to 8 as well as settings other than preset positions, and up to 8 VIQS areas can be set for each preset position.

To check the image after configuring VIQS, when H.264 images are selected under “Stream”, you can check the image by pressing the [Confirm] button. You can also check by displaying an H.264 or H.265 image on the “Live” page.

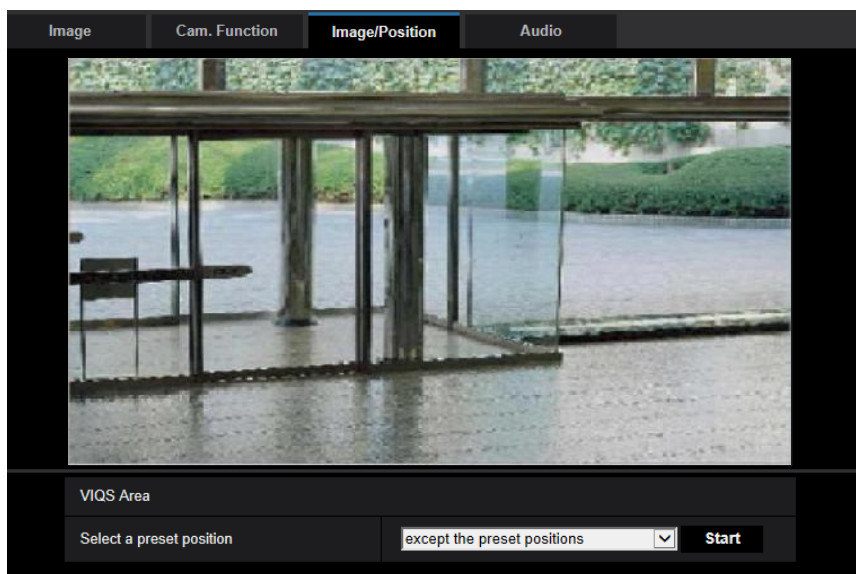

#### VIQS Area

##### [Select a preset position]

In order to configure a VIQS area, select the preset position number of the VIQS area that you want to configure, and then click the [Start] button.

## 2 Settings

In order to configure a VIQS area outside of preset areas, select “except the preset positions”.

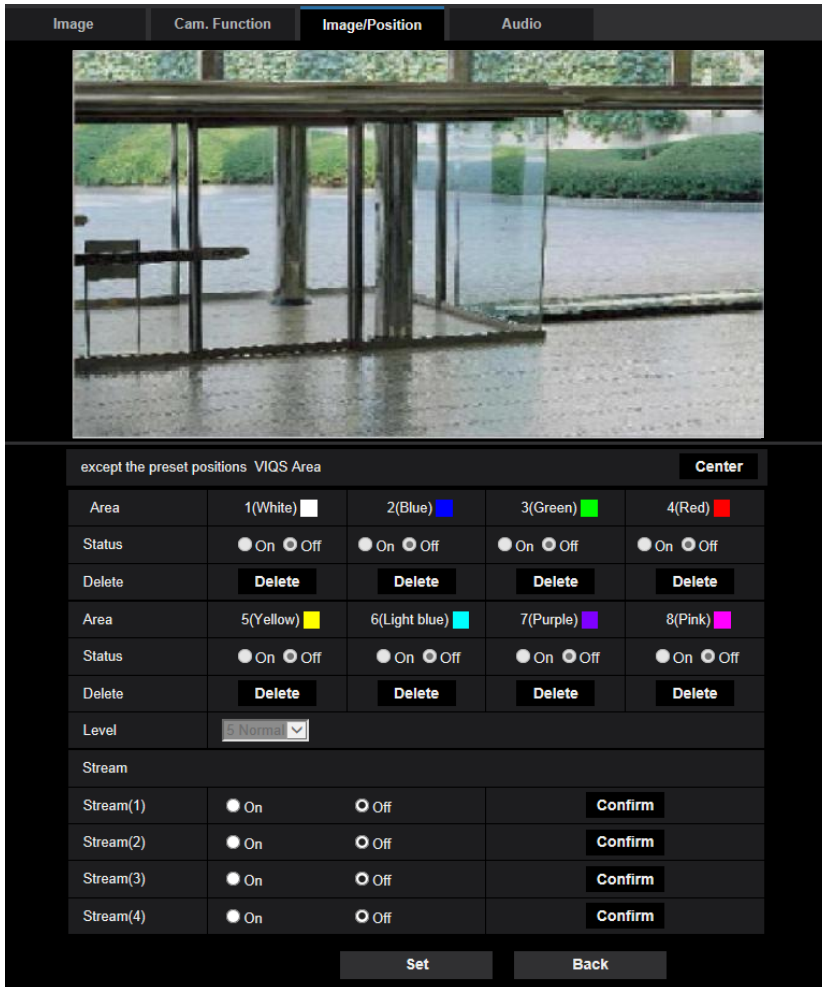

### [Area]

When selecting a VIQS area in the screen, it will be numbered as area 1. (Subsequent areas will be numbered in the order of selection.)

### [Center]

When the [Center] button is clicked, the whole area will become the VIQS area, and “1(White)” will be automatically applied to “Area”.

### [Status]

Select “On” or “Off” to determine whether or not to use the VIQS area.

- **On:** The VIQS area will be set.
- **Off:** Does not set the VIQS area.
- **Default:** Off

### [Delete] button

Deletes the VIQS area. Click the button to delete the VIQS area.

**[Level]**

Configure the difference level in the image quality between specified areas and non-specified areas. The greater the difference level, the more the image quality of the non-specified area is reduced. This makes it possible to moderate the image data size.

0 Min./ 1/ 2/ 3/ 4/ 5 Normal/ 6/ 7/ 8/ 9 Max.

- **Default:** 5 Normal

### 2.5.5.10 Configure the VIQS area

The VIQS area is specified by following the steps below.

1. Drag the mouse on the screen to specify the area (up to 8 areas).
  - The specified area is set to area “1(White)”, and the outline is displayed.
  - The areas are set in the area number order from number 1. The color next to the area number show the color of the corresponding outline.

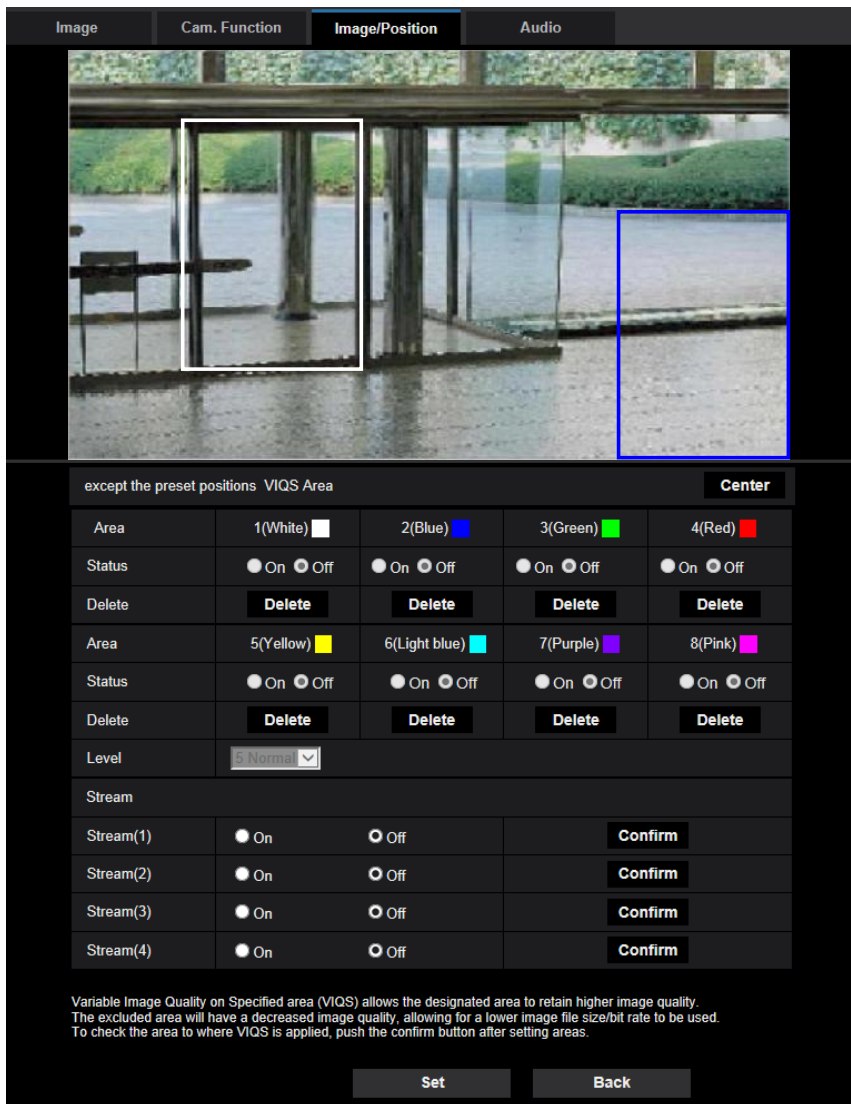

2. Configure the difference level in the image quality between specified areas and non-specified areas. The greater the difference level, the more the image quality of the non-specified area is reduced. This makes it possible to moderate the image data size.
3. Select “On”/“Off” to activate/deactivate a distributed image of “Stream(1)”, “Stream(2)”, “Stream(3)”, or “Stream(4)”.
4. Click the [Set] button.
  - This unit is updated with the setting contents. Click the [Delete] button corresponding to the area to be deleted.



**5.** Click the [Confirm] button.

→ The image (“Stream(1)”, “Stream(2)”, “Stream(3)”, or “Stream(4)”) that the [Confirm] button was pressed for is displayed. When a window is newly opened and about 3 seconds pass, the currently outputted bit rate can be confirmed with the configured VIQS.

**IMPORTANT**

- No setting contents are determined unless the [Set] button is clicked.
- To check the image after configuring VIQS, display an H.264 or H.265 image on the “Live” page, or press the [Confirm] button under “Stream”.
- The outputted bit rate changes depending on the subject. Confirm the bit rates with actual subjects used when operating the camera.
- When using “Smart Facial Coding”, “VIQS Area” cannot be enabled.

### 2.5.6 Configure the settings relating to audio [Audio]

Click the [Audio] tab on the “Image/Audio” page. (→For menu display and how to operate, refer to page 47, page 48)

The settings relating to audio can be configured on this page.

#### Note

- Images and audio will not be synchronized. Therefore, images and audio may not always match.
- Audio may be interrupted depending on the network environment.

Image		Cam. Function		Image/Position		Audio	
Mic input							
Mic input volume		Mic Middle					
AGC (audio)		High					
Audio bit rate	G.726(Live)	32kbps					
	G.711(Live)	[Slider]					
	AAC-LC(Live/Recording)	128kbps					
Audio transmission/reception							
Audio transmission mode		Off					
Mic input interval (Camera to PC)		[Slider]					
Audio output volume (PC to Camera)		[Slider]					
Audio output interval (PC to Camera)		[Slider]					
Audio output duration		[Slider]					
Audio output port (PC to Camera)		3.5004 (1024-50000)					
Live page							
Audio input encoding format		[Slider]					
Audio volume control mode		<input checked="" type="radio"/> Adjust PC speaker <input type="radio"/> Adjust Mic input					
Set							

## Mic input

### [Mic input volume]

Set the audio volume for input into the camera. This setting is reflected in the volume when listening to audio on a PC (mic input to PC), and in the volume during “Audio recording” or during “Audio detection”.

- **Mic High/Mic Middle/Mic Low:** Set the volume when audio is input to the camera using a microphone.
- **Line High/Line Middle/Line Low:** Set the volume when audio is input to the camera using line input.
- **Default:** Mic Middle

### [AGC (audio)]

Automatically adjusts the audio reception to a suitable volume. The degree to which the volume is adjusted can be selected from High/Middle/Low.

When “High” is selected, it is easier to hear quiet sounds, but sounds may be heard as noise. If you do not want to hear noise, select “Middle” or “Low”. These settings are linked with the volume settings of the “Audio recording” and “Audio detection”.

- **Default:** High

**IMPORTANT**

- If the [AGC (audio)] setting is changed after configuring [Audio detection], the volume of the sound that is detected with [Audio detection] may change. In this case, make sure to check the [Audio detection] setting.

**[Audio bit rate]**

Set the audio compression bit rate.

[G.726(Live)]: 16kbps/32kbps

[G.711(Live)]: 64kbps (cannot be changed)

[AAC-LC(Live/Recording)]: 64kbps/96kbps/128kbps

- **Default:**
  - [G.726(Live)]: 32kbps
  - [AAC-LC(Live/Recording)]: 128kbps

**Audio transmission/reception****[Audio transmission mode]**

Select the communication mode used for audio data transmission/reception between the camera and the PC from the following:

- **Off:** Does not receive/transmit audio between the camera and the PC.
- **Mic Input (To PC):** PC receives the audio data from the camera. On the PC, the image can be viewed together with the accompanying audio. The image and audio are not synchronized.
- **Audio output(From PC):** Transmits audio data from the PC to the camera. Audio can be heard from the speaker connected to the camera.
- **Interactive(Half-duplex):** Both reception and transmission are available. However, audio data cannot simultaneously be transmitted and received.
- **Interactive(Full-duplex):** Both reception and transmission are simultaneously available.
- **Default:** Off

**Note**

- Howling may be generated depending on the usage conditions. Prevent sound generated by the PC from entering the PC microphone.
- When “Multicast” is selected for “Transmission type” on the [Image] tab of the “Image/Audio” page, audio output will become unavailable while monitoring H.265 or H.264 images. To perform audio output, click the [JPEG] button on the “Live” page.
- If you have set the “Audio out” to “Monitor”, you can only set the “Audio transmission mode” to “Off” or “Mic Input (To PC)”.
- “Audio recording” and “Audio detection” are not available when “Interactive(Half-duplex)” is selected for “Audio transmission mode”.

**[Mic input interval (Camera to PC)]**

Select an interval for audio reception from the following.

20ms/ 40ms/ 80ms/ 160ms

- **Default:** 40ms

**Note**

- When a shorter interval is selected, the delay time will be shorter. When a longer interval is selected, audio interruption may be diminished even though the delay time will be longer. Select the interval according to the network environment.
- “Mic input interval (Camera to PC)” is unavailable when “AAC-LC” is selected for “Audio input encoding format”.

### [Audio output volume (PC to Camera)]

Select a volume level on the camera to hear audio transmitted from the PC.

High/ Middle/ Low

- **Default:** Middle

### [Audio output interval (PC to Camera)]:

Select an interval for audio transmission from the following.

160ms/ 320ms/ 640ms/ 1280ms

- **Default:** 640ms

#### **Note**

- When a shorter interval is selected, the delay time will be shorter. When a longer interval is selected, audio interruption may be diminished even though the delay time will be longer. Select the interval according to the network environment.
- Audio may temporarily be interrupted and noise may be heard when multiple users are accessing the camera concurrently. It may be possible to diminish the interruption or noise by setting a longer interval for "Audio output interval (PC to Camera)".
- Audio may sometimes not be heard depending on the network environment.

### [Audio output duration]

Configure the maximum duration for each time audio is outputted.

1min/ 2min/ 3min/ 5min/ 10min/ 20min/ 30min/ 1h

- **Default:** 5min

#### **Note**

- Audio output stops when the specified time has passed. To turn the audio transmission function on, click the Audio output button again.

### [Audio output port (PC to Camera)]

Enter the transmission port number (the port number on the camera used to receive audio data transmitted from the PC).

Available port number: 1024-50000 (Only even numbers are available.)

- **Default:** 34004

#### **Note**

- The transmission port number entered for "Audio output port (PC to Camera)" will be used only when "Unicast port (MANUAL)" is selected for "Transmission type" (→page 102). When "Off" is selected for "Stream transmission" (→page 98) or when "Unicast port (AUTO)" or "Multicast" is selected for "Transmission type", it is not necessary to enter the transmission port number.

## "Live" page

### [Audio input encoding format]

Select the audio input encoding format to be used in the "Live" page from G.726, G.711, or AAC-LC.

- **Default:** G.726

#### **Note**

- G.711 is available only when the "Mic Input (To PC)" is selected for "Audio transmission mode".
- G.726 is always applied for the audio transmission encoding format.

### [Audio volume control mode]

Select the operation method using the volume cursor of the Mic input button on the "Live" page.

- **Adjust PC speaker:** Change the volume of the PC in which the "Live" page is opened.

- **Adjust Mic input:** Change the mic input volume of the camera.
- **Default:** Adjust Mic input

## 2.6 Configure the multi-screen settings [Multi-screen]

The cameras from which images are to be displayed on a multi-screen can be registered on the “Multi-screen” page. (→For menu display and how to operate, refer to page 47, page 48)

		IP address	Camera title
Group A	Cam. 1	selfcamera	
	Cam. 2		
	Cam. 3		
	Cam. 4		
Group B	Cam. 5		
	Cam. 6		
	Cam. 7		
	Cam. 8		
Group C	Cam. 9		
	Cam. 10		
	Cam. 11		
	Cam. 12		
Group D	Cam. 13		
	Cam. 14		
	Cam. 15		
	Cam. 16		

Example of entry: `http://192.168.0.10:8080`

Initial display

Layout: 4 Screens(1-4)

Refresh interval: MJPEG

Image capture size(4 Screens): 320x180

Set

### [IP address]

Enter the IP address or the host name of the camera to be used for the multi-screen. 4 cameras can be registered as a group and up to 4 groups (16 cameras) can be registered.

When the HTTP port number for the camera of which images are to be displayed had been changed, enter as follows:

#### Example of entry:

- **Example when entering an IPv4 address:** `http://192.168.0.10:8080`
- **Example when entering an IPv6 address:** `http://[2001:db8:0:0:0:0:1]:8080`

To access the cameras using the HTTPS protocol, enter as follows:

**Example of entry:** `https://192.168.0.10/`

- **Available number of characters:** 1 - 128 characters
- **Default:** (Cam. 1) selfcamera, (Cam. 2 - 16) not registered

**IMPORTANT**

- When accessing the camera using the HTTPS protocol, install the pre-installed certificate or the CA certificate of the camera to display images on the monitor. (→page 219)
- For further information about “Network Camera Recorder with Viewer Software Lite”, which is suited to viewing images from several cameras, refer to our website (<https://security.panasonic.com/support/info/>).
- This camera is specified when “selfcamera” is displayed for the IP address or host name.

**Note**

- For further information about “Network Camera Recorder with Viewer Software Lite”, which is suited to viewing images from several cameras, refer to our website (<https://security.panasonic.com/support/info/>).
- When using the host name, it is necessary to configure the DNS settings of the PC to be used for the multi-screen display. Refer to the network administrator for information on the DNS setting of PCs.

**[Camera title]**

Enter the title of the camera. The entered camera title will be displayed on a multi-screen.

- **Available number of characters:** 0 - 20 characters
- **Unavailable characters:** " &
- **Default:**
  - (Cam. 1) The model No. is displayed.
  - (Cam. 2 - 16) None (blank)

**Note**

- When selecting a 16 split-screen, some characters of the camera title to be displayed may not be displayed.

**Initial display****[Layout]**

Select the layout for the initial display from the following:

4 Screens(1-4)/ 4 Screens(5-8)/ 4 Screens(9-12)/ 4 Screens(13-16)/ 9 Screens(1-9)/ 9 Screens(10-16)/ 16 Screens

- **Default:** 4 Screens(1-4)

**[Refresh interval]**

Select the refresh interval during initial display.

- **H.265(1):** Displays the camera image in the H.265 format (video).
- **H.264(1):** Displays the camera image in the H.264 format (video).
- **MJPEG:** Displays the camera image in the motion JPEG format (video).
- **Refresh interval : 1s/ Refresh interval : 3s/ Refresh interval : 5s/ Refresh interval : 10s/ Refresh interval : 30s/ Refresh interval : 60s:** Displays the JPEG format (still image) camera image in the selected interval.
- **Default:** MJPEG

**[Image capture size(4 Screens)]**

Select either “640x360” (VGA) or “320x180” (QVGA) for the image capture size for 4 screens in the initial display.

- **Default:** 320x180

## 2.7 Configure the alarm settings [Alarm]

The settings relating to alarm occurrences such as settings for the alarm action at an alarm occurrence or alarm images, the VMD area settings, audio detection settings, and the alarm occurrence notification can be configured on this page.

The “Alarm” page has the [Alarm] tab, the [VMD area] tab, the [Audio detection] tab, and the [Notification] tab.

### 2.7.1 Configure the settings relating to the alarm action [Alarm]

Click the [Alarm] tab on the “Alarm” page. (→For menu display and how to operate, refer to page 47, page 48)

The settings relating to the alarm can be configured in this section. Refer to page 156 and page 154 for further information about the settings relating to the alarm images and the alarm output terminal.

Alarm		VMD area	Audio detection	Notification
Alarm				
Terminal 1	Off			
Terminal 2	Off			
Terminal 3	Off			
VMD alarm	VMD >>			
Auto track alarm	Auto track setting >>			
Audio detection alarm	Audio detection >>			
Command alarm	Command alarm	<input checked="" type="radio"/> On <input type="radio"/> Off		
	Reception port	8181 (1-65535)		
Alarm deactivation time	5 s (5-600s)			

## Alarm

### [Terminal 1]

Determine how to use terminal 1.

- **Off:** Not used.
- **Alarm input(TRM1):** Receives alarms. When “Alarm input” is selected, a pull-down menu for “Close” and “Open” is displayed.
  - **Close:** An alarm is detected when the terminal status is changed to “Close”.
  - **Open:** An alarm is detected when the terminal status is changed to “Open”.
- **Black & white input:** Receives the black & white switchover input. (When the input is set to On, the black & white mode is activated.)
- **Auto time adjustment:** Receives the time adjustment input. When the signal is received and if the clock is within 29 minutes ± the hour, the time will be adjusted to 00 minutes 00 seconds. When the time setting is moved back by less than 5 seconds, the time is not changed. When “Auto time adjustment” is selected, a pull-down menu for “Close” and “Open” is displayed.
  - **Close:** The time is adjusted when the terminal status is changed to “Close”.
  - **Open:** The time is adjusted when the terminal status is changed to “Open”.
- **Default:** Off

### [Terminal 2]

Determine how to use terminal 2.

- **Off:** Not used.



- **Alarm input(TRM2):** Receives alarms. When “Alarm input” is selected, a pull-down menu for “Close” and “Open” is displayed.
  - **Close:** An alarm is detected when the terminal status is changed to “Close”.
  - **Open:** An alarm is detected when the terminal status is changed to “Open”.
- **Alarm output:** Alarm output will be carried out according to the settings for “Output terminal” (→page 154).
- **Default:** Off

### [Terminal 3]

Determine how to use terminal 3.

- **Off:** Not used.
- **Alarm input(TRM3):** Receives alarms. When “Alarm input” is selected, a pull-down menu for “Close” and “Open” is displayed.
  - **Close:** An alarm is detected when the terminal status is changed to “Close”.
  - **Open:** An alarm is detected when the terminal status is changed to “Open”.
- **AUX output:** AUX output will be supplied. The [AUX] buttons will be displayed on the “Live” page.
- **Default:** Off

### **IMPORTANT**

- In order for the EXT I/O terminals to detect alarm inputs when the terminal status is changed from Open to Close (On) or from Close to Open (Off), about 100 ms or more is needed. Because alarms cannot be detected for about 5 seconds after a detection is made, alarm inputs received within about 5 seconds after an alarm is detected are not detected.

### Note

- AUX is a camera terminal that allows users to operate (Open/Close) arbitrarily from the “Live” page. For example, an operator can remotely control lights in a place where the camera is installed by connecting the terminal to the light controller.
- Refer to the Important Information on the provided CD-ROM for further information about input/output rating of each terminal.

### [VMD alarm]

When clicking “VMD >>”, the [VMD area] tab of the “Alarm” page will be displayed. (→page 168)

### [Auto track alarm]

When “Auto track setting >>” is clicked, the [Image/Position] tab of the “Image/Audio” page will be displayed. The setup menu will be displayed in a newly opened window. (→Page 131)

### [Audio detection alarm]

When “Audio detection>>” is clicked, the [Audio detection] tab will be displayed. (→page 170)

### [Command alarm]

Select “On” or “Off” to determine whether or not to receive the command alarm.

The command alarm is the function that provides notification of a Panasonic protocol alarm from the other cameras. When “On” is selected, alarm actions will be performed between multiple cameras.

- **Default:** Off

### [Reception port]

Select a port number to be used to receive the command alarm.

- **Available range:** 1-65535
- **Default:** 8181

The following port numbers are unavailable since they are already in use.

20, 21, 23, 25, 42, 53, 67, 68, 69, 80, 110, 123, 161, 162, 443, 554, 995, 10669, 10670, 59000-61000

### [Alarm deactivation time]

Configure the duration that detections won't be made after an alarm is detected. For example, by using this function you can prevent E-mail from being sent too often when E-mail notifications are configured to be sent to cellular phones when an alarm is detected.

5-600s

- **Default:** 5s

### Note

- The duration that alarm detections are not made can be managed for each type of alarm. For example, during the time when detections for command alarms are not made, detections for VMD alarm can be made.

## 2.7.2 Configure the settings relating to the output terminal

### [Alarm]

Click the [Alarm] tab on the "Alarm" page. (→For menu display and how to operate, refer to page 47, page 48)

The settings relating to the output terminal can be configured in this section.

Output terminal	
Terminal output upon alarm detection	<input type="radio"/> On <input type="radio"/> Off
SD memory card error	<input type="radio"/> On <input type="radio"/> Off
Terminal state upon alarm detection	<input type="radio"/> Latch <input type="radio"/> Pulse
Terminal action upon alarm detection	<input type="radio"/> Open <input type="radio"/> Close
Pulse output width	<input type="text" value=""/> s (1-120s)

## Output terminal

In order to be able to configure "Output terminal", "Alarm output" must be selected for [Terminal 2] of the [Alarm] setting.

### [Terminal output upon alarm detection]

Select "On" or "Off" to determine whether or not to output the alarm signals to the output terminal when an alarm is detected.

- **Default:** Off

### [SD memory card error]

Select "On" or "Off" to determine whether or not to output signals from the output terminal when an error is detected for the SD memory card.

SD memory card error condition: SD memory card error (write error, read error, etc), Total use time over 6 years, and number of overwrites over 2000 times

- **On:** When an error status is detected, the signals from an output terminal is outputted and the [Alarm occurrence indication] button on the "Live" page blinks.
- **Off:** Deactivates the warning status detection.
- **Default:** Off

### IMPORTANT

- In order to be able to correctly use this function, format the SD memory card with the camera before using it.

**Note**

- The total service time of 6 years is the total power-on time from the SD card being inserted. 2000 cycles are the upper limit overwrite counts of the industrial SD memory card (MLC type). These are typical values and not a guarantee of the SD card lifetime.
- The output terminal and the SD memory card errors use the same output terminal.
- A signal is outputted to the output terminal when either an alarm or SD memory card error occurs.
- When an SD memory card error is detected, the [Alarm occurrence indication] button on the “Live” page blinks. If you click on the [Alarm occurrence indication] button, the button will be hidden.
- Output signals from the output terminal for [SD memory card error] differ depending on the settings of [Terminal state upon alarm detection].
  - When “Latch” is selected: Even after you click the [Alarm occurrence indication] button and it disappears, output signals from the output terminal will continue as long as the cause of the [SD memory card error] is not resolved.
  - When “Pulse” is selected: Even after you click the [Alarm occurrence indication] button and it disappears, output signals from the output terminal will continue as long as the cause of the [SD memory card error] is not resolved. However, if the time period specified for [Pulse output width] is exceeded, output signals from the output terminal will be stopped.

**[Terminal state upon alarm detection]**

Select “Latch” or “Pulse” for the output terminal at an alarm occurrence.

- **Latch:** When an alarm is detected, the output terminal will be in the state selected for “Terminal action upon alarm detection” until the alarm occurrence indication button is clicked.
- **Pulse:** When an alarm is detected, the output terminal will be in the state to the “Terminal action upon alarm detection” setting for the period set for “Pulse output width”. When the alarm occurrence indication button is clicked, the output terminal will return to the normal state.
- **Default:** Latch

**[Terminal action upon alarm detection]**

Select “Open” or “Close” to determine whether to open or close the output terminal when outputting the alarm signals.

- **Open:** The output terminal will open when outputting the alarm signals. (Normally close)
- **Close:** The output terminal will close when outputting the alarm signals. (Normally open)
- **Default:** Close

**Note**

- When “Open” is selected, the alarm signal will be output for about 20 seconds when the power of the unit is turned on.

**[Pulse output width]**

When “Pulse” is selected for “Terminal state upon alarm detection”, select an output terminal duration from the following.

- **Available range:** 1-120s
- **Default:** 1s

## 2.7.3 Change the AUX name [Alarm]

Click the [Alarm] tab on the “Alarm” page. (→For menu display and how to operate, refer to page 47, page 48)

## 2 Settings

---

The names of “AUX”, “Open” and “Close” on the “Live” page can be changed.

AUX title	
AUX (Up to 10 characters)	<input type="text" value="AUX"/>
Open (Up to 5 characters)	<input type="text" value="Open"/>
Close (Up to 5 characters)	<input type="text" value="Close"/>

### AUX title

#### [AUX (Up to 10 characters)]

Enter the name for “AUX” on the “Live” page.

- **Unavailable characters:** " &
- **Default:** AUX

#### [Open (Up to 5 characters)]

Enter the name for “Open” of “AUX” on the “Live” page.

- **Unavailable characters:** " &
- **Default:** Open

#### [Close (Up to 5 characters)]

Enter the name for “Close” of “AUX” on the “Live” page.

- **Unavailable characters:** " &
- **Default:** Close

#### Note

- When AUX setting is not available, AUX name cannot be changed.
- AUX is a camera terminal that allows users to operate (Open/Close) arbitrarily from the “Live” page. For example, an operator can remotely control lights in a place where the camera is installed by connecting the terminal to the light controller.

## 2.7.4 Configure the settings relating to the camera action on alarm occurrence [Alarm]

Click the [Alarm] tab on the “Alarm” page. (→For menu display and how to operate, refer to page 47, page 48)

The settings related to the camera action on alarm can be configured in this section.

Camera action on alarm	
Terminal alarm 1	<input type="button" value="Off"/> ▾
Terminal alarm 2	<input type="button" value="Off"/> ▾
Terminal alarm 3	<input type="button" value="Off"/> ▾
VMD alarm	<input type="button" value="Off"/> ▾
Audio detection alarm	<input type="button" value="Off"/> ▾
Command alarm	<input type="button" value="Off"/> ▾
	<a href="#">Preset per sender &gt;&gt;</a>
Image compression rate upon alarm detection	<a href="#">Image compression rate upon alarm detection setup &gt;&gt;</a>
Alarm E-mail notification	<a href="#">E-mail server &gt;&gt;</a>
Alarm image FTP transmission	<a href="#">FTP setup &gt;&gt;</a>
Alarm image recording(SD memory card)	<a href="#">SD memory card setup &gt;&gt;</a>
Panasonic alarm protocol	<a href="#">Panasonic alarm protocol notification &gt;&gt;</a>
HTTP alarm notification	<a href="#">HTTP alarm notification setup &gt;&gt;</a>

### [Terminal alarm 1]

Select an action to be taken when a terminal alarm 1 is detected from the following.

This setting is available when "Terminal 1" is selected for "Alarm input(TRM1)" of the [Alarm] tab.

- **Off:** Does not take any action even when a terminal alarm 1 is detected.
- **1-256:** If a previously registered preset position is selected, when a terminal alarm 1 is detected, the camera will move to that position.
- **Auto track:** When a terminal alarm 1 is detected, the camera will start the auto tracking.
- **Patrol 1:** When a terminal alarm 1 is detected, the camera will start the patrol.  
\* If "Patrol 1" is not registered, it is not displayed on the screen.
- **Default:** Off

### [Terminal alarm 2]

Select an action to be taken when a terminal alarm 2 is detected from the following.

This setting is available when "Terminal 2" is selected for "Alarm input(TRM2)" of the [Alarm] tab.

- **Off:** Does not take any action even when a terminal alarm 2 is detected.
- **1-256:** If a previously registered preset position is selected, when a terminal alarm 2 is detected, the camera will move to that position.
- **Auto track:** When a terminal alarm 2 is detected, the camera will start the auto tracking.
- **Patrol 2:** When a terminal alarm 2 is detected, the camera will start the patrol.  
\* If "Patrol 2" is not registered, it is not displayed on the screen.
- **Default:** Off

### [Terminal alarm 3]

Select an action to be taken when a terminal alarm 3 is detected from the following.

This setting is available when "Terminal 3" is selected for "Alarm input(TRM3)" of the [Alarm] tab.

- **Off:** Does not take any action even when a terminal alarm 3 is detected.
- **1-256:** If a previously registered preset position is selected, when a terminal alarm 3 is detected, the camera will move to that position.
- **Auto track:** When a terminal alarm 3 is detected, the camera will start the auto tracking.
- **Patrol 3:** When a terminal alarm 3 is detected, the camera will start the patrol.  
\* If "Patrol 3" is not registered, it is not displayed on the screen.
- **Default:** Off

### [VMD alarm]

Select an action to be taken when a VMD alarm is detected from the following.

- **Off:** Does not take any action even when a VMD alarm is detected.
- **1-256:** If a previously registered preset position is selected, when a VMD alarm is detected, the camera will move to that position.
- **Auto track:** When a VMD alarm is detected, the camera will start the auto tracking.
- **Patrol 1:** When a VMD alarm is detected, the camera will start the patrol.  
\* If "Patrol 1" is not registered, it is not displayed on the screen.
- **Default:** Off

### [Audio detection alarm]

Select an action to be taken when a sound alarm is detected from the following.

- **Off:** Does not take any action even when a sound alarm is detected.
- **1-256:** If a previously registered preset position is selected, when a sound alarm is detected, the camera will move to that position.
- **Auto track:** When a sound alarm is detected, the camera will start the auto tracking.
- **Patrol 1:** When a sound alarm is detected, the camera will start the patrol.  
\* If "Patrol 1" is not registered, it is not displayed on the screen.
- **Default:** Off

### [Command alarm]

Select an action to be taken when a command alarm is detected from the following.

This setting is available when "On" is selected for "Command alarm".

- **Off:** Does not take any action even when a command alarm is detected.
- **1-256:** If a previously registered preset position is selected, when a command alarm is detected, the camera will move to that position.
- **Auto track:** When a command alarm is detected, the camera will start the auto tracking.
- **Patrol 1:** When a command alarm is detected, the camera will start the patrol.  
\* If "Patrol 1" is not registered, it is not displayed on the screen.
- **Preset per sender:** By registering the sender's address for the command alarm and the preset position for that address, the camera will move to the preset position when an alarm is detected from the command alarm.  
Click "Preset per sender >>" to open a separate window for setting the preset positions per sender.  
(→Page 159)
- **Default:** Off

### [Image compression rate upon alarm detection]

Click "Image compression rate upon alarm detection setup >>" to display the setup menu that can configure the settings relating to image quality when an alarm occurs. The setup menu will be displayed in a newly opened window. (→page 159)

### [Alarm E-mail notification]

Click "E-mail server >>" to display the setup menu that can configure the settings relating to E-mail notification when an alarm occurs. The setup menu will be displayed in a newly opened window. (→page 161)

### [Alarm image FTP transmission]

Click "FTP setup >>" to display the setup menu that can configure the settings relating to FTP transmission when an alarm occurs. The setup menu will be displayed in a newly opened window. (→page 162)

### [Alarm image recording(SD memory card)]

Click "SD memory card setup >>" to display the setup menu that can configure the settings relating to recording images on an SD memory card when an alarm occurs. The setup menu will be displayed in a newly opened window. (→page 163)

**[Panasonic alarm protocol]**

Click “Panasonic alarm protocol notification >>” to display the setup menu that can configure the settings relating to transmitting Panasonic alarm protocol notifications when an alarm occurs. The setup menu will be displayed in a newly opened window. (→page 164)

**[HTTP alarm notification]**

Click “HTTP alarm notification setup >>” to display the setup menu that can configure the settings relating to transmitting HTTP alarm notifications when an alarm occurs. The setup menu will be displayed in a newly opened window. (→page 165)

### 2.7.4.1 Configure the settings relating to Preset per sender (“Preset per sender” setup menu)

On the [Alarm] tab of the “Alarm” page (→Page 156), click “Preset per sender” for “Command alarm”. The sender’s address for the command alarm, and the preset position for that address can be registered in this section.

Preset per sender	Auto track cooperation	
Sender's address 1	<input type="checkbox"/>	<input type="text"/>
Sender's address 2	<input type="checkbox"/>	<input type="text"/>
Sender's address 3	<input type="checkbox"/>	<input type="text"/>
Sender's address 4	<input type="checkbox"/>	<input type="text"/>
Sender's address 5	<input type="checkbox"/>	<input type="text"/>
Sender's address 6	<input type="checkbox"/>	<input type="text"/>
Sender's address 7	<input type="checkbox"/>	<input type="text"/>
Sender's address 8	<input type="checkbox"/>	<input type="text"/>

**[Sender's address 1] - [Sender's address 8]**

Set the sender’s IP address for the command alarm, and the preset position for that address. Up to 8 notification addresses can be set.

**[Auto track cooperation] checkbox:** When the checkbox is selected, auto tracking starts after the direction of the camera moves to the preset position.

**[Close] button**

Click this button to close the “Preset per sender” setup menu.

### 2.7.4.2 Configure settings relating to image quality on alarm action

Click “Image compression rate upon alarm detection setup >>” of “Camera action on alarm” on the [Alarm] tab of the “Alarm” page. (→page 156)

Image compression rate upon alarm detection(JPEG)	
Image compression rate upon alarm detection	<input checked="" type="radio"/> On <input type="radio"/> Off
Image quality upon alarm detection	<input type="text" value="Normal"/>

### **[Image compression rate upon alarm detection]**

Select "On" or "Off" to determine whether or not to change the image quality (→page 96) upon alarm detection.

- **On:** Images will be transmitted with the image quality selected for "Image quality upon alarm detection".
- **Off:** Does not change the image quality upon alarm detection.
- **Default:** Off

### **[Image quality upon alarm detection]**

Image quality can be changed upon an alarm occurrence. Select the image quality from the following.

0 Super fine/ 1 Fine/ 2/ 3/ 4/ 5 Normal/ 6/ 7/ 8/ 9 Low

- **Default:** 5 Normal



### 2.7.4.3 Configure settings relating to alarm E-mail notifications

Click “E-mail server >>” of “Camera action on alarm” on the [Alarm] tab of the “Alarm” page. (→page 156)

E-mail notification	
E-mail notification	<input type="radio"/> On <input type="radio"/> Off
Alarm image attachment	<input type="radio"/> On <input type="radio"/> Off
Image capture size	JPEG(2) (640x360)
SMTP server address	<input type="text"/> Example of entry: 192.168.0.10
SMTP port	25 (1-65535)
POP server address	<input type="text"/> Example of entry: 192.168.0.10
Authentication	Type <input type="radio"/> None <input type="radio"/> POP before SMTP <input type="radio"/> SMTP
	User name <input type="text"/>
	Password <input type="text"/>
Sender's E-mail address	<input type="text"/>
SSL	<input type="radio"/> On <input type="radio"/> Off
Destination of notification	Destination E-mail address
Address 1	<input type="text"/> <input type="button" value="Delete"/>
	<input type="checkbox"/> Terminal 1 <input type="checkbox"/> Terminal 2 <input type="checkbox"/> Terminal 3 <input type="checkbox"/> VMD <input type="checkbox"/> Command alarm <input type="checkbox"/> Audio detection <input type="checkbox"/> Diag. <input type="checkbox"/> Auto track
Address 2	<input type="text"/> <input type="button" value="Delete"/>
	<input type="checkbox"/> Terminal 1 <input type="checkbox"/> Terminal 2 <input type="checkbox"/> Terminal 3 <input type="checkbox"/> VMD <input type="checkbox"/> Command alarm <input type="checkbox"/> Audio detection <input type="checkbox"/> Diag. <input type="checkbox"/> Auto track
Address 3	<input type="text"/> <input type="button" value="Delete"/>
	<input type="checkbox"/> Terminal 1 <input type="checkbox"/> Terminal 2 <input type="checkbox"/> Terminal 3 <input type="checkbox"/> VMD <input type="checkbox"/> Command alarm <input type="checkbox"/> Audio detection <input type="checkbox"/> Diag. <input type="checkbox"/> Auto track
Address 4	<input type="text"/> <input type="button" value="Delete"/>
	<input type="checkbox"/> Terminal 1 <input type="checkbox"/> Terminal 2 <input type="checkbox"/> Terminal 3 <input type="checkbox"/> VMD <input type="checkbox"/> Command alarm <input type="checkbox"/> Audio detection <input type="checkbox"/> Diag. <input type="checkbox"/> Auto track
E-mail subject	<input type="checkbox"/> Use the camera title <input type="checkbox"/> Cause of alarm
E-mail body	<input checked="" type="checkbox"/> Cause of alarm <input checked="" type="checkbox"/> Occurrence time
	<input type="text"/>
Terminal name	
Terminal 1 (Up to 10 characters)	<input type="text"/>
Terminal 2 (Up to 10 characters)	<input type="text"/>
Terminal 3 (Up to 10 characters)	<input type="text"/>
<input type="button" value="Set"/> <input type="button" value="Close"/>	

Refer to page 191 for information on configuration for these settings.

## 2.7.4.4 Configure settings relating to FTP transmissions of alarm images

Click “FTP setup >>” of “Camera action on alarm” on the [Alarm] tab of the “Alarm” page. (→page 156)

FTP			
Alarm image FTP transmission	<input checked="" type="radio"/> On <input type="radio"/> Off		
Directory name	<input type="text"/>		
File name	<input checked="" type="checkbox"/> Terminal 1 <input checked="" type="checkbox"/> Terminal 2 <input checked="" type="checkbox"/> Terminal 3 <input checked="" type="checkbox"/> VMD <input checked="" type="checkbox"/> Command alarm <input checked="" type="checkbox"/> Audio detection <input checked="" type="checkbox"/> Auto track		
FTP transmission retry	<input type="radio"/> On <input checked="" type="radio"/> Off		
Pre alarm	Transmission interval 1 fps	Maximum number of images 0 pic	Recording duration 0s
Post alarm	Transmission interval 1 fps	Number of images 100 pic	Recording duration 100s
Image capture size	.JPEG (640x360)		
FTP server address	<input type="text"/> Example of entry: 192.168.0.10		
User name	<input type="text"/>		
Password	<input type="text"/>		
Control port	21 (1-65535)		
FTP mode	<input type="radio"/> Passive <input checked="" type="radio"/> Active		
		Set	Close

Refer to page 196 for information on configuration for these settings.

## 2.7.4.5 Configure settings relating to recording to an SD memory card when an alarm occurs

Click “SD memory card setup >>” of “Camera action on alarm” on the [Alarm] tab of the “Alarm” page.  
(→page 156)

Operating mode	
SD memory card	<input type="radio"/> Use <input type="radio"/> Not use
Audio recording	<input type="radio"/> On <input type="radio"/> Off
Remaining capacity notification	50% <input type="text"/>
Overwrite	<input type="radio"/> On <input type="radio"/> Off
SD memory card security	
Additional info for detecting alteration	<input type="button" value="Setup &gt;&gt;"/>
Recording stream 1	
Recording format	JPEG(2) <input type="text"/> (640x360)
	FTP periodic image transmission error <input type="text"/>
Save trigger	<input checked="" type="checkbox"/> Terminal 1 <input checked="" type="checkbox"/> Terminal 2 <input checked="" type="checkbox"/> Terminal 3 <input checked="" type="checkbox"/> VMD <input checked="" type="checkbox"/> Command alarm <input checked="" type="checkbox"/> Audio detection <input checked="" type="checkbox"/> Auto track
Recording stream 2	
Recording format	Off <input type="text"/>
	Alarm type <input type="text"/>
Save trigger	<input checked="" type="checkbox"/> Terminal 1 <input checked="" type="checkbox"/> Terminal 2 <input checked="" type="checkbox"/> Terminal 3 <input checked="" type="checkbox"/> VMD <input checked="" type="checkbox"/> Command alarm <input checked="" type="checkbox"/> Audio detection <input checked="" type="checkbox"/> Auto track
<input type="button" value="Set"/> <input type="button" value="Close"/>	

Refer to page 78 for information on configuration for these settings.

### 2.7.4.6 Configure settings relating to Panasonic alarm protocol notification when an alarm occurs

Click “Panasonic alarm protocol notification >>” of “Camera action on alarm” on the [Alarm] tab of the “Alarm” page. (→page 156)

Panasonic alarm protocol notification			
Panasonic alarm protocol	<input checked="" type="radio"/> On	<input type="radio"/> Off	
Additional alarm data	<input checked="" type="radio"/> On	<input type="radio"/> Off	
Destination port	<input type="text" value="1010"/> (1-65535)		
Retry times	<input type="text" value="2"/>		
Destination of notification			
	Alarm	Diag.	Destination server address
Address 1	<input type="checkbox"/>	<input type="checkbox"/>	<input type="text"/>
Auto track cooperation	<input checked="" type="radio"/> On	<input type="radio"/> Off	Alarm area No. <input type="text"/>
			<input type="button" value="Delete"/>
Address 2	<input type="checkbox"/>	<input type="checkbox"/>	<input type="text"/>
Auto track cooperation	<input checked="" type="radio"/> On	<input type="radio"/> Off	Alarm area No. <input type="text"/>
			<input type="button" value="Delete"/>
Address 3	<input type="checkbox"/>	<input type="checkbox"/>	<input type="text"/>
Auto track cooperation	<input checked="" type="radio"/> On	<input type="radio"/> Off	Alarm area No. <input type="text"/>
			<input type="button" value="Delete"/>
Address 4	<input type="checkbox"/>	<input type="checkbox"/>	<input type="text"/>
Auto track cooperation	<input checked="" type="radio"/> On	<input type="radio"/> Off	Alarm area No. <input type="text"/>
			<input type="button" value="Delete"/>
Address 5	<input type="checkbox"/>	<input type="checkbox"/>	<input type="text"/>
Auto track cooperation	<input checked="" type="radio"/> On	<input type="radio"/> Off	Alarm area No. <input type="text"/>
			<input type="button" value="Delete"/>
Address 6	<input type="checkbox"/>	<input type="checkbox"/>	<input type="text"/>
Auto track cooperation	<input checked="" type="radio"/> On	<input type="radio"/> Off	Alarm area No. <input type="text"/>
			<input type="button" value="Delete"/>
Address 7	<input type="checkbox"/>	<input type="checkbox"/>	<input type="text"/>
Auto track cooperation	<input checked="" type="radio"/> On	<input type="radio"/> Off	Alarm area No. <input type="text"/>
			<input type="button" value="Delete"/>
Address 8	<input type="checkbox"/>	<input type="checkbox"/>	<input type="text"/>
Auto track cooperation	<input checked="" type="radio"/> On	<input type="radio"/> Off	Alarm area No. <input type="text"/>
			<input type="button" value="Delete"/>
Example of entry: 192.168.0.10			
		<input type="button" value="Set"/>	<input type="button" value="Close"/>

Refer to page 173 for information on configuration for these settings.

## 2.7.4.7 Configure settings relating to HTTP alarm notification when an alarm occurs

Click “HTTP alarm notification setup >>” of “Camera action on alarm” on the [Alarm] tab of the “Alarm” page. (→page 156)

HTTP alarm notification		Alarm	
Address 1	<input type="checkbox"/>	<input type="text" value="http://"/>	<input type="button" value="Delete"/>
User name		<input type="text"/>	
Password		<input type="text"/>	
Notification data		<input type="text" value="/cgi-bin/comalarm.cgi?CMD=01"/>	
Address 2	<input type="checkbox"/>	<input type="text" value="http://"/>	<input type="button" value="Delete"/>
User name		<input type="text"/>	
Password		<input type="text"/>	
Notification data		<input type="text" value="/cgi-bin/comalarm.cgi?CMD=01"/>	
Address 3	<input type="checkbox"/>	<input type="text" value="http://"/>	<input type="button" value="Delete"/>
User name		<input type="text"/>	
Password		<input type="text"/>	
Notification data		<input type="text" value="/cgi-bin/comalarm.cgi?CMD=01"/>	
Address 4	<input type="checkbox"/>	<input type="text" value="http://"/>	<input type="button" value="Delete"/>
User name		<input type="text"/>	
Password		<input type="text"/>	
Notification data		<input type="text" value="/cgi-bin/comalarm.cgi?CMD=01"/>	
Address 5	<input type="checkbox"/>	<input type="text" value="http://"/>	<input type="button" value="Delete"/>
User name		<input type="text"/>	
Password		<input type="text"/>	
Notification data		<input type="text" value="/cgi-bin/comalarm.cgi?CMD=01"/>	
		<input type="button" value="Set"/>	<input type="button" value="Close"/>

Refer to page 175 for information on configuration for these settings.

## 2.7.5 Configure the VMD settings [VMD area]

Click the [VMD area] tab on the “Alarm” page. (→For menu display and how to operate, refer to page 47, page 48)

The video motion detection areas can be set on this page.

The VMD areas can be set up to 4 areas for each preset position (maximum 256 preset positions). When motion is detected in the set area, it will be regarded as an alarm.

The camera can be configured to take an alarm action even when the camera is not at the preset position.

### IMPORTANT

- The alarm occurrence indication button (→page 12) will be displayed when motion is detected by the VMD function.
- The alarm occurrence indication button will be displayed when receiving an alarm input of a terminal alarm or a command alarm.
- Depending on the network environment, notification may be delayed even when “Real time” is selected for “Status update mode” on the [Basic] tab of the “Basic” page (→page 71).
- After configuring the VMD area, the VMD area may move out of alignment when “Image capture mode” of the [Image] tab is changed. Make sure to check the VMD area after changing the “Image capture mode” setting.
- The motion detection function is not the dedicated function to prevent thefts, fires, etc. We are not responsible for any accidents or damages that may occur.

### Preset position selection and VMD information addition

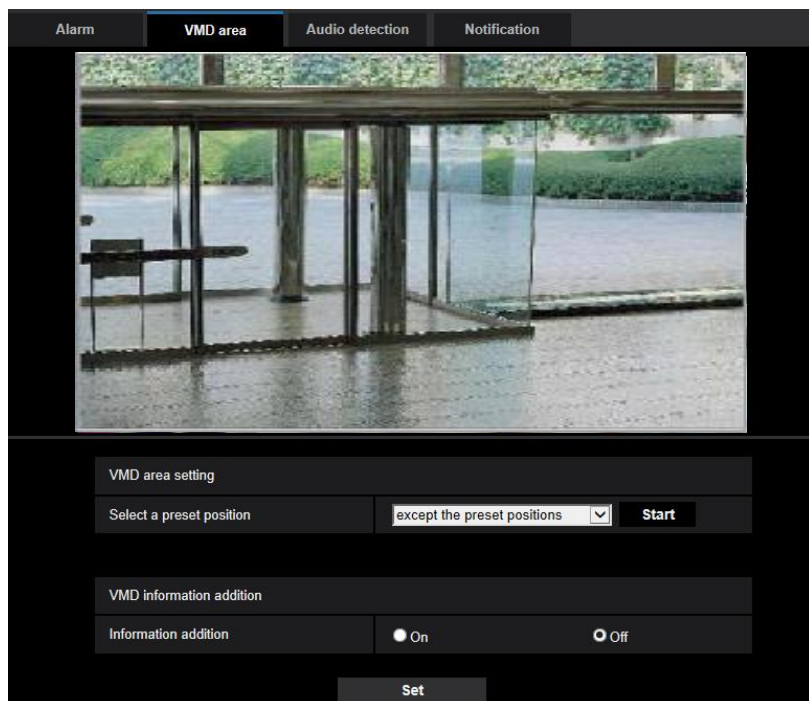

#### VMD area setting

- **[Select a preset position]**  
Select a preset position number to which the VMD area is to be set, and click the [Start] button.  
When setting an area which is not at the preset position for the VMD area, select VMD activation in area “except the preset positions”.

#### VMD information addition

- **[Information addition]**  
Select “On” or “Off” to determine whether or not to add VMD information to superimposed image data.  
The VMD information can be searched by some of Panasonic network disk recorders.  
Refer to the operating instructions of the connected devices for further information about the functions and settings.
  - **Default:** Off

## VMD area setting

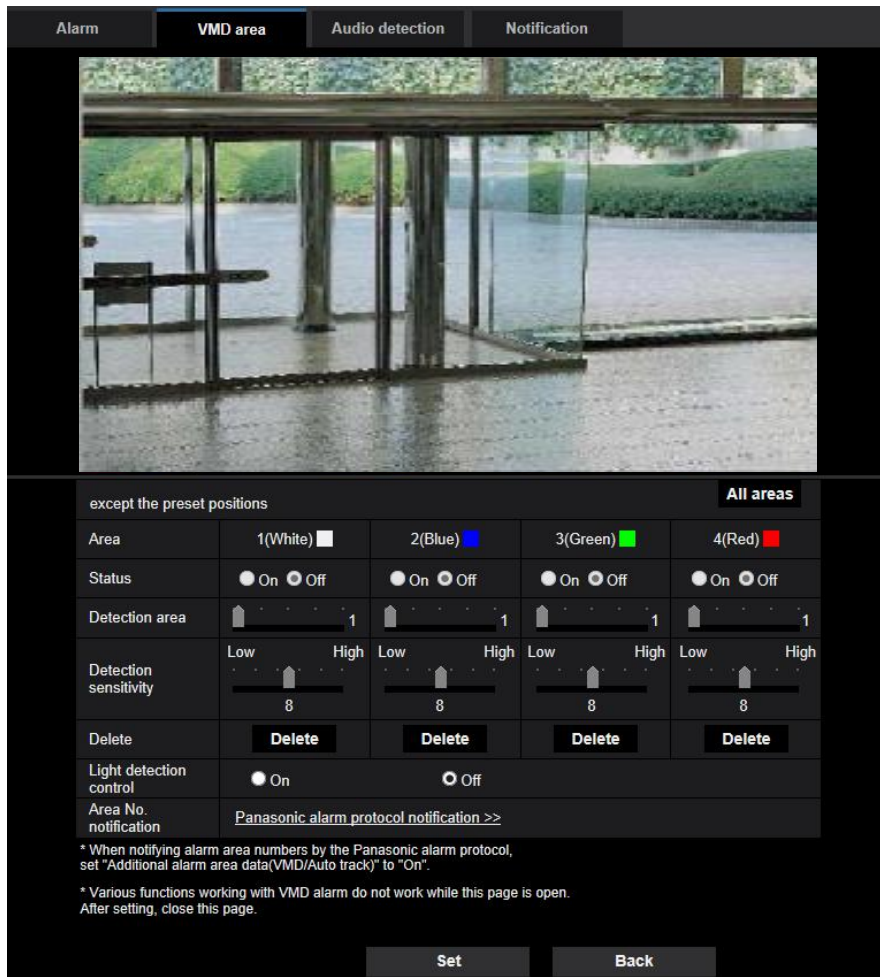

### [Area]

When selecting a VMD area in the screen, it will be numbered as area 1. (Subsequent areas will be numbered in the order of selection.)

### [Status]

Select "On" or "Off" to determine whether or not to perform video motion detection.

- **On:** Performs video motion detection.
- **Off:** Does not perform video motion detection.
- **Default:** Off

### [Detection area]

Adjust the size of the VMD area using the slider. The smaller the selected value is, the higher the sensitivity of VMD area becomes. The current value (1-10) will be displayed on the right of the slider.

- **Default:** 1

### [Detection sensitivity]

Adjust the sensitivity of motion detection in the VMD area using the slider. The settings can be configured for each area individually. The larger the value is set, the higher the sensitivity level becomes.

The current value (1 (low) - 15 (high)) will be displayed below the slider.

- **Default:** 8

### [Delete] button

Click the [Delete] button corresponding to the area to be deleted. The outline of the selected area will be deleted.

### [Light detection control]

Select "On" or "Off" to determine whether or not to suspend video motion detection affected by brightness change such by a dimming level control.

- **Default:** Off

### **IMPORTANT**

- "Light detection control" may not work when brightness change is too small.
- When "On" is selected for "Light detection control", the video motion detection may not be performed even when detecting a subject moving over the whole screen.

### [Area No. notification]

When "Panasonic alarm protocol notification >>" is clicked, the [Notification] tab of the "Alarm" page will be displayed. (→page 172)

## 2.7.6 Set the VMD areas [VMD area]

Set the areas to activate the VMD function.

### **IMPORTANT**

- During change of setting in the setup menu, no alarm will be detected. After setup is complete, close the setup menu.



1. Set the video motion detection area by dragging the mouse on the screen.  
 → The designated area will become the VMD area “1(White)” and the outline will be displayed. When 2 - 4 VMD areas are set, each area will be numbered in order. The areas will be identified by the respective outline colors. The “Status” of the outline to be set for the area will become “On”.

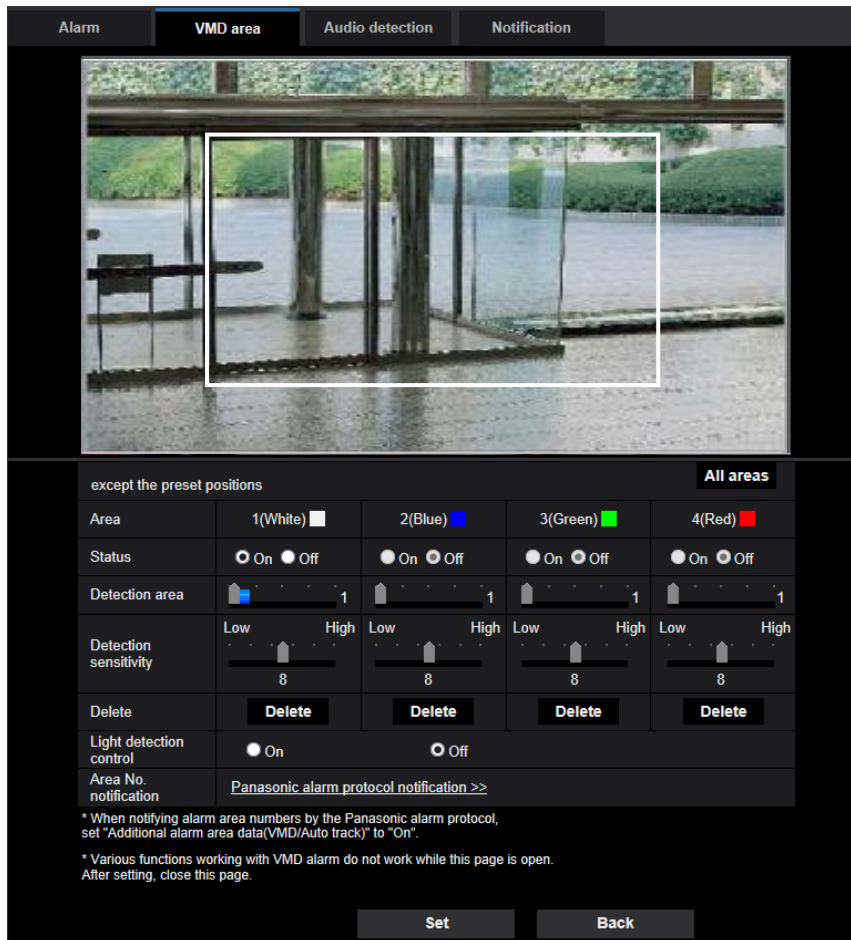

2. Adjust “Detection area” and “Detection sensitivity” using the slider.  
 Refer to page 165 for further information about the “Detection sensitivity” and “Detection area”.  
 The currently displayed area and its detection sensitivity will be displayed in the “Detection area” section.  
 Change areas and the settings of “Detection area” and “Detection sensitivity” as necessary.
3. Click the [Set] button after completing the settings.

### IMPORTANT

- The setting will not be applied unless the [Set] button is clicked.
4. To invalidate the VMD area, click the [Set] button after selecting “Off” for “Status” of the VMD area to be invalidated.  
 → The outline of the invalidated VMD area will turn to a dotted line. When the VMD area is invalidated, no alarm will occur even when a motion can be recognized in the area.
  5. To delete the VMD area, click the [Delete] button corresponding to the area to be deleted.  
 → The outline of the respective VMD area will disappear.

- Click the [Set] button.  
→ The edited settings will be applied.
- Click the [Back] button to return to the screen to select a preset position.

### 2.7.7 Configure the settings relating to the audio detection [Audio detection]

Click the [Audio detection] tab on the “Alarm” page. (→For menu display and how to operate, refer to page 47, page 48)

The settings relating to audio detection can be configured in this section. When the configured audio detection level is exceeded, the alarm action will be performed.

The audio detection level can be adjusted in 10 levels.

#### **IMPORTANT**

- The alarm occurrence indication button will be displayed when sound is detected by the audio detection function. (→page 12)
- The alarm occurrence indication button will also be displayed when receiving an alarm input of a terminal alarm or a command alarm.
- Notification may be delayed in some network environments even when “Real time” is selected for “Status update mode” on the [Basic] tab of the “Basic” page. (→page 71)
- The audio detection feature is not designed to be used in situations that require high reliability. We are not responsible for any accidents or damages that may occur.
- During change of setting in the setup menu, no alarm will be detected. After setup is complete, close the setup menu.

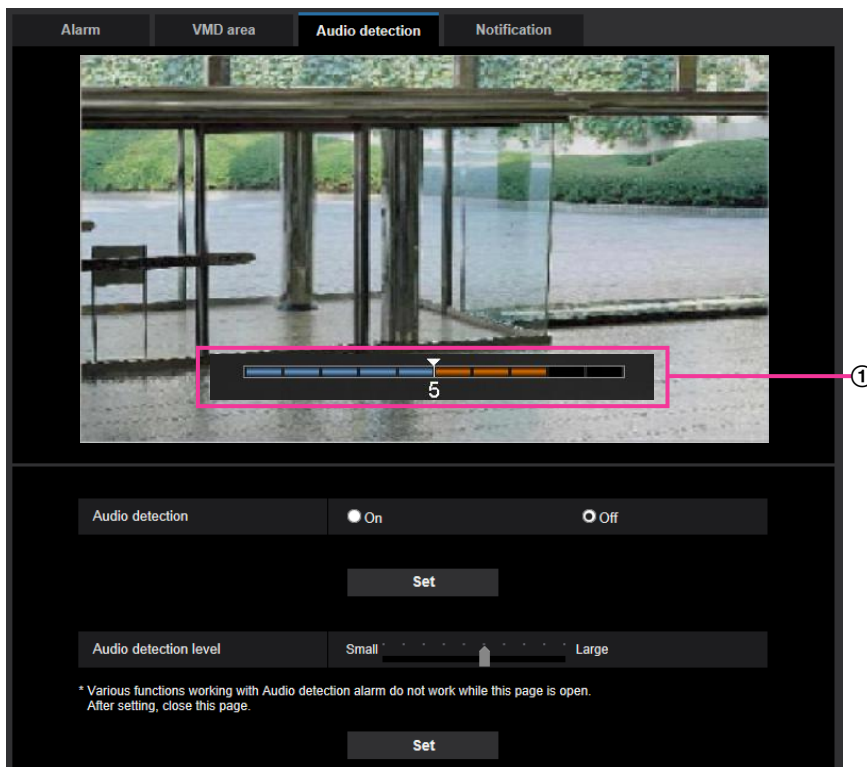

- ① Preview  
Displays a preview of the settings and the actual audio detection status.

### [Audio detection]

Select “On” or “Off” to determine whether or not to perform audio detection.

- **On:** Performs audio detection.
- **Off:** Does not perform audio detection.
- **Default:** Off

### Note

- The volume level for when audio detection is performed can be changed in “Mic input volume” on the [Audio] tab of the “Image/Audio” page. (→page 146)

### [Audio detection level]

Select the level at which the camera determines that there is sound in the area around the camera when detecting sound.

If you only want to detect loud sounds, raise the audio detection level; if you also want to detect quiet sounds, lower the audio detection level.

## Configure the audio detection level

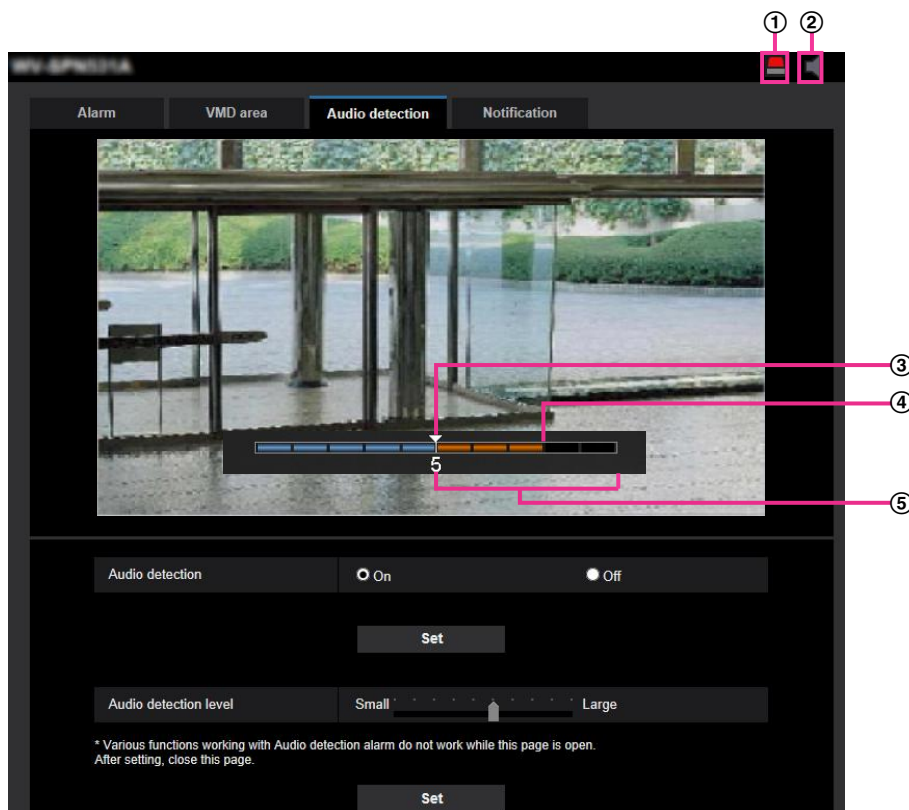

- ① Alarm occurrence indication button
- ② Mic input button
- ③ Audio detection level
- ④ The current volume level
- ⑤ Range of volumes to be detected

1. Check the audio detection level and current volume level.  
→ The volume level configured in “Mic input volume” on the [Audio] tab of the “Image/Audio” page is displayed in the preview.
2. Adjust the “Audio detection level” with the slider bar so that it is lower than the volume level that you want to detect.
3. Adjust the “Mic input volume” on the [Audio] tab of the “Image/Audio” page as necessary. (→page 146)  
→ The settings and the actual audio detection status are displayed on the bottom of the screen. If the volume level goes above the audio detection level, a red bar, which indicates that sound has been detected, is displayed.

If further adjustments are required, repeat from step 2.

### **Note**

- Noise or other unwanted sound from the surrounding area may be mistakenly detected.
- Only the volume of the sound determines whether sound is detected or not, the type of sound does not matter.

## **2.7.8 Configuration of the settings relating to alarm notification [Notification]**

Click the [Notification] tab on the “Alarm” page. (→For menu display and how to operate, refer to page 47, page 48)

The settings relating to Panasonic alarm protocol and HTTP alarm notification can be configured in this section.

## 2.7.8.1 Configure the settings relating to Panasonic alarm protocol

Panasonic alarm protocol notification | [HTTP alarm notification](#)

Panasonic alarm protocol notification

Panasonic alarm protocol  On  Off

Additional alarm data  On  Off

Destination port  (1-65535)

Retry times

Destination of notification	Alarm	Diag.	Destination server address	
Address 1 Auto track cooperation	<input type="checkbox"/>	<input type="checkbox"/>	<input type="text"/>	Delete Alarm area No. <input type="text"/>
Address 2 Auto track cooperation	<input type="checkbox"/>	<input type="checkbox"/>	<input type="text"/>	Delete Alarm area No. <input type="text"/>
Address 3 Auto track cooperation	<input type="checkbox"/>	<input type="checkbox"/>	<input type="text"/>	Delete Alarm area No. <input type="text"/>
Address 4 Auto track cooperation	<input type="checkbox"/>	<input type="checkbox"/>	<input type="text"/>	Delete Alarm area No. <input type="text"/>
Address 5 Auto track cooperation	<input type="checkbox"/>	<input type="checkbox"/>	<input type="text"/>	Delete Alarm area No. <input type="text"/>
Address 6 Auto track cooperation	<input type="checkbox"/>	<input type="checkbox"/>	<input type="text"/>	Delete Alarm area No. <input type="text"/>
Address 7 Auto track cooperation	<input type="checkbox"/>	<input type="checkbox"/>	<input type="text"/>	Delete Alarm area No. <input type="text"/>
Address 8 Auto track cooperation	<input type="checkbox"/>	<input type="checkbox"/>	<input type="text"/>	Delete Alarm area No. <input type="text"/>

Example of entry: 192.168.0.10

Set

### Panasonic alarm protocol notification

#### [Panasonic alarm protocol]

Select “On” or “Off” to determine whether or not to provide notification by Panasonic alarm protocol according to the settings for the “Alarm” and “Diag.” checkboxes of “Destination of notification” below.

- When an alarm is detected (“Alarm”)

- When a notification of the remaining capacity of the SD memory card has been provided (“Diag.”)
- When the SD memory card has become full (“Diag.”)
- When the SD memory card cannot be recognized (“Diag.”)
- **Default:** Off

### Note

- When “On” is selected, notification of the alarm occurrence will be provided to the registered destination server addresses in order (to IP address 1 first, to IP address 8 last).

### [Additional alarm data]

Determine whether or not to send notifications for VMD alarm detection area numbers with the Panasonic alarm protocol by selecting On/Off.

- **Default:** Off

### [Destination port]

Select a destination port for the Panasonic alarm protocol from the following.

- **Available range:** 1 - 65535
- **Default:** 1818

The following port numbers are unavailable since they are already in use.

20, 21, 23, 25, 42, 53, 67, 68, 69, 80, 110, 123, 161, 162, 443, 995, 10669, 10670

### [Retry times]

Select a retry time for the Panasonic alarm protocol.

- **Available range:** 0-30
- **Default:** 2

## Destination of notification

### [Address 1] - [Address 8]

Enter the destination IP address or host name of the Panasonic alarm protocol from the following. Up to 8 destination server addresses can be registered.

- **[Alarm] checkbox:** When the checkbox is checked, the Panasonic alarm notification will be provided upon an alarm occurrence.
- **[Diag.] checkbox:** When the checkbox is checked, notification using Panasonic alarm protocol will be provided in the following cases.
  - When notification of the remaining capacity of the SD memory card has been provided
  - When the SD memory card has become full
  - When the SD memory card cannot be recognized
- **[Destination server address]:** Enter the destination server address or host name.
  - **Available characters:** Alphanumeric characters, the colon (:), the period (.), the underscore (\_), and the hyphen (-).

To delete the registered destination server address, click the [Delete] button respective to the desired destination server address.

### [Auto track cooperation]

Select whether to perform auto track cooperation setup by selecting On/Off.

When “On” is selected for “Auto track cooperation”, alarm notification is only implemented when the number of the “Alarm area” set in auto track alarm conforms with the alarm area number. Alarm notifications other than auto track alarms are not implemented.

When using auto track cooperation, set “Auto track alarm” to “On(In preset alarm area)” in the auto tracking settings. (→Page 133)

- **Default:** Off

**[Alarm area No.]**

- **Available range:** 1-4
- **Default:** 1

**IMPORTANT**

- When entering the host name of the “Destination server address”, the DNS settings on the [Network] tab of the “Network” page must be configured. (→page 185)
- Confirm that the destination IP addresses are registered correctly. When a registered destination does not exist, notification may be delayed.

**2.7.8.2 Configure the settings relating to HTTP alarm notification**

HTTP alarm notification		Alarm	
Address 1	<input type="checkbox"/>	<input type="text" value="http://"/>	<input type="button" value="Delete"/>
User name		<input type="text"/>	
Password		<input type="text"/>	
Notification data		<input type="text" value="/cgi-bin/comalarm.cgi?CMD=01"/>	
Address 2	<input type="checkbox"/>	<input type="text" value="http://"/>	<input type="button" value="Delete"/>
User name		<input type="text"/>	
Password		<input type="text"/>	
Notification data		<input type="text" value="/cgi-bin/comalarm.cgi?CMD=01"/>	
Address 3	<input type="checkbox"/>	<input type="text" value="http://"/>	<input type="button" value="Delete"/>
User name		<input type="text"/>	
Password		<input type="text"/>	
Notification data		<input type="text" value="/cgi-bin/comalarm.cgi?CMD=01"/>	
Address 4	<input type="checkbox"/>	<input type="text" value="http://"/>	<input type="button" value="Delete"/>
User name		<input type="text"/>	
Password		<input type="text"/>	
Notification data		<input type="text" value="/cgi-bin/comalarm.cgi?CMD=01"/>	
Address 5	<input type="checkbox"/>	<input type="text" value="http://"/>	<input type="button" value="Delete"/>
User name		<input type="text"/>	
Password		<input type="text"/>	
Notification data		<input type="text" value="/cgi-bin/comalarm.cgi?CMD=01"/>	

**HTTP alarm notification****[Address 1] - [Address 5]**

Enter the destination IP address or host name of the HTTP alarm notification. Up to 5 destination server addresses can be registered.

- **Available characters:** Alphanumeric characters, the colon (:), the period (.), the underscore (\_), and the hyphen (-).
- **Default:** http://

**Example of entry:** “http://IP address of the HTTP server + : (colon) + port number” or “http://Host name: (colon) + port number”

**[Alarm] checkbox**

When the checkbox is checked, the HTTP alarm notification will be provided upon an alarm occurrence.

### [Delete] button

When this button is clicked, all configured information, including the address, user name, password, and notification data, will be deleted.

### [User name]

Enter the user name (login name) to access the HTTP server.

- **Available number of characters:** 0 - 63 characters
- **Unavailable characters:** " & ; \

### [Password]

Enter the password to access the HTTP server.

- **Available number of characters:** 0 - 63 characters
- **Unavailable characters:** " &

### [Notification data]

Enter the notification data to add after the destination HTTP server addresses set in [Address 1] - [Address 5].

- **Available characters:** Alphanumeric characters
- **Default:** /cgi-bin/comalarm.cgi?CMD=01

### Note

- For "Address 1" to "Address 5", a total of 256 characters can be entered for the address (including "http://") and "Notification data".
- Make sure to enter a slash (/) as the first character for "Notification data".
- If the HTTP alarm notification fails, information about the failure will be added to the system log.
- Even if the [Set] button is clicked after deleting the contents of "Notification data", "/cgi-bin/comalarm.cgi?CMD=01" will be set.
- HTTPS cannot be used.

### <Example>

When `http://192.168.0.100` is set for the address and `/cgi-bin/comalarm.cgi?CMD=01` is set for "Notification data", an HTTP alarm notification such as `http://192.168.0.100/cgi-bin/comalarm.cgi?CMD=01` will be executed.



---

## 2.8 Configure the settings relating to the authentication [User mng.]

The settings relating to the authentication such as users and PCs restrictions for accessing the camera with a PC or cellular phone/mobile terminal can be configured on the “User mng.” page.

The “User mng.” page has 4 tabs; the [User auth.] tab, the [Host auth.] tab, the [IEEE 802.1X] tab and [Data encryption] tab.

### 2.8.1 Configure the settings relating to the user authentication [User auth.]

Click the [User auth.] tab on the “User mng.” page. (→For menu display and how to operate, refer to page 47, page 48)

The settings relating to the authentication of users who can access this camera from the PC or a cellular phone/mobile terminal can be configured on this page. Up to 24 users can be registered.

## 2 Settings

### Note

- When user authentication has failed to pass (authentication error) 8 times within 30 seconds using the same IP address (PC), access to the unit will be denied for a while.

User auth. Host auth. IEEE 802.1X Data encryption

User auth.  On  Off

Guest User  Use  Not use

Authentication Digest or Basic

Set

User name registration --New registration-- Change Delete

User name (1 to 32 characters)

Password (8 to 32 characters)

Retype password

Access level 3. Live only

Set

Note:

(1) Distinguish between upper- and lower cases.  
(2) Entry of the following is not allowed as a user name: 2-byte characters, and 1-byte symbols " & : ; \   
(3) Entry of the following is not allowed as a password: 2-byte characters, and 1-byte symbols " &   
(4) For the password, use two or more types of characters from alphabetic characters, numbers, and symbols.  
(5) Keep the user name and password at hand so as not to lose.  
(6) It is recommended to change the password periodically.

Access level	Camera control	Live only	Guest User
Live view selectable	<input checked="" type="checkbox"/>	<input type="checkbox"/>	<input type="checkbox"/>
Listen	<input checked="" type="checkbox"/>	<input type="checkbox"/>	<input type="checkbox"/>
Talk	<input checked="" type="checkbox"/>	<input type="checkbox"/>	<input type="checkbox"/>
Refresh Rate	<input checked="" type="checkbox"/>	<input type="checkbox"/>	<input type="checkbox"/>
Snap shot	<input checked="" type="checkbox"/>	<input type="checkbox"/>	<input type="checkbox"/>
Playback of recording (Log disp.)	<input checked="" type="checkbox"/>	<input type="checkbox"/>	<input type="checkbox"/>
Manual rec./Delete rec.	<input checked="" type="checkbox"/>	<input type="checkbox"/>	<input type="checkbox"/>
Preset	<input checked="" type="checkbox"/>	<input type="checkbox"/>	<input type="checkbox"/>
Pan/Tilt	<input checked="" type="checkbox"/>	<input type="checkbox"/>	<input type="checkbox"/>
Zoom	<input checked="" type="checkbox"/>	<input type="checkbox"/>	<input type="checkbox"/>
Focus	<input checked="" type="checkbox"/>	<input type="checkbox"/>	<input type="checkbox"/>
Auto mode	<input checked="" type="checkbox"/>	<input type="checkbox"/>	<input type="checkbox"/>
Brightness	<input checked="" type="checkbox"/>	<input type="checkbox"/>	<input type="checkbox"/>
AUX	<input checked="" type="checkbox"/>	<input type="checkbox"/>	<input type="checkbox"/>

Set

### [User auth.]

Select "On" or "Off" to determine whether or not to authenticate the users.

- Default:** On

### [Guest User]

Select whether or not to set Guest User. If you select "Use", you can set which functions are available or unavailable for guest users for whom user authentication has not been performed.

- Default:** Not use

**[Authentication]**

Set the user authentication method.

- **Digest or Basic:** Uses “Digest or Basic” authentication.
- **Digest:** Uses “Digest” authentication.
- **Basic:** Uses “Basic” authentication.
- **Default:** Digest or Basic

**Note**

- When the [Authentication] setting has been changed, close the web browser, and then access the camera again.
- For other devices such as network disk recorders, unless otherwise stated, digest authentication is not supported. (As of August, 2016)

**[User name registration]**

At the time of new registration, register a new user name in [User name]. Click [▼] in “User name registration” to view registered users. Registered users are displayed as “Registered user name [Access level]”. (Example: admin [1])

If you click the [Change] button on the right, the selected user will be displayed in [User name], and you can change the password. By clicking the [Delete] button on the right, you can delete the selected user.

**[User name]**

Enter a user name.

- **Available number of characters:** 1 - 32 characters
- **Unavailable characters:** " & ; \
- **Default:** None (blank)

**Note**

- When the user name already in use is entered and the [Set] button is clicked, the respective user information will be overwritten.

**[Password (8 to 32 characters)] [Retype password]**

Enter a password.

- **Available number of characters:** 8 - 32 characters
- **Unavailable characters:** " &
- **Default:** None (blank)

**Note**

- Distinguish between upper- and lower cases.
- For the password, use two or more types of characters from alphabetic characters, numbers, and symbols.

**[Access Level]**

Select the access level of the user from the following.

- **1. Administrator:** Allowed all available operations of the camera.
- **2. Camera control:** Allowed to control the camera. Functions selected for “Access level” can be operated.
- **3. Live only:** Allowed to display live view. Functions selected for “Access level” can be operated.
- **Default:** 3. Live only

**[Access level]**

Select the available functions based on the user access level (camera control, live view, guest user).

- **Default:**
  - Camera control: All are checked
  - Live only: All are not checked

- Guest User: All are not checked

**Note**

- **If you have set “User authentication” to “Off”, and “Guest User” to “Not use”:**  
The “Access Level” item cannot be set. And, while all the live operation buttons are displayed, the [Setup] buttons require authentication.
- **If you have set “User authentication” to “Off”, and “Guest User” to “Use”:**  
You can set the items for “Guest User”.
- **If you have set “User authentication” to “On”:**  
You cannot set the items for “Guest User”.

You can set the following functions.

Live view selectable	Selecting an image displayed in the live view setting permissions
Listen	Mic Input (To PC) (when listening on a PC) setting permissions (→page 16)
Talk	Audio output (From PC) (when talking from a PC) setting permissions (→page 16)
Refresh Rate	JPEG format image refresh interval setting permissions (→page 13)
Snap shot	Snap shot operation permissions (→page 16)
Playback of recording (Log disp.)	Log operation permissions (→page 13)
Manual rec./Delete rec.	SD memory card save/delete permissions (→page 13)
Preset	Operation permissions for moving the preset positions (→Page 15)
Pan/Tilt	Pan/tilt operation permissions (→Page 15)
Zoom	Zoom operation permissions (→Page 13)
Focus	Focus operation permissions (→Page 14)
Auto mode	Auto mode operation permissions (→Page 14)
Brightness	Brightness setting permissions (→Page 15)
AUX	AUX setting permissions (→Page 13)

## 2.8.2 Configure the settings relating to the host authentication [Host auth.]

Click the [Host auth.] tab on the “User mng.” page. (→For menu display and how to operate, refer to page 47, page 48)

The restriction settings of PCs (IP address) from accessing the camera can be configured on this page.

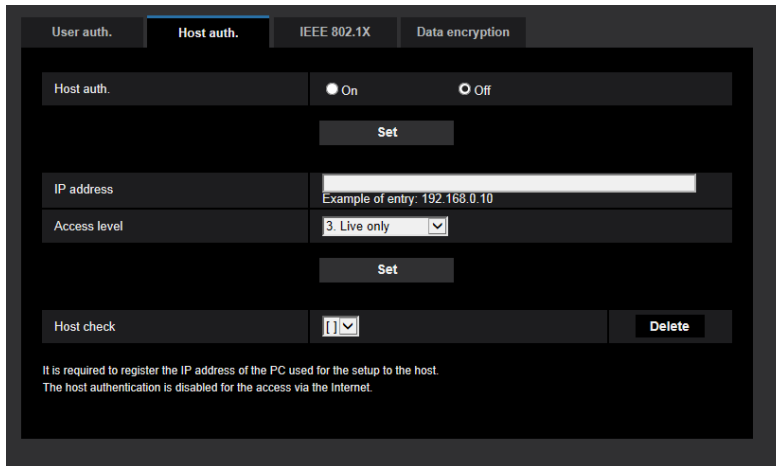

### [Host auth.]

Select “On” or “Off” to determine whether or not to authenticate the host.

- **Default:** Off

### **IMPORTANT**

- Set “Host auth.” to “On” after registering the IP address of the PC.

### [IP address]

Enter the IP address of the PC to be allowed to access the camera. Host name cannot be entered for the IP address.

### Note

- When “IP address/subnet mask” is entered, it is possible to restrict PCs in each subnet. For example, when “192.168.0.1/24” is entered and “2. Camera control” is selected for the access level, the PCs whose IP address is between “192.168.0.1” - “192.168.0.254” can access the camera with the access level “2. Camera control”.
- When the IP address already in use is entered and the [Set] button is clicked, the respective host information will be overwritten.
- A “Set address” error message is displayed if the IP address of the PC has not been set properly. Check the set IP address of the PC again.

### [Access level]

Select the access level of the host from the following.

1. Administrator/ 2. Camera control/ 3. Live only

Refer to page 177 for further information about the access level.

- **Default:** 3. Live only

### [Host check]

From the pull-down menu of “Host check”, the registered host can be selected and the selected host’s IP address can be checked.

The registered IP address will be displayed with the access level.

(Example: 192.168.0.21 [1])

To delete the registered host, click the [Delete] button after selecting the IP address to be deleted.

### 2.8.3 Configure IEEE 802.1X [IEEE 802.1X]

Click the [IEEE 802.1X] tab on the “User mng.” page. (→For menu display and how to operate, refer to page 47, page 48)

The settings relating to IEEE 802.1X can be configured on this page.

#### [IEEE 802.1X]

Select “On” or “Off” to determine whether or not to perform port authentication using IEEE 802.1X.

- **Default:** Off

#### [User name]

Enter the user name to access the authentication LAN switch.

- **Available number of characters:** 1 - 32 characters
- **Unavailable characters:** " & ; \

#### [Password]

#### [Retype password]

Enter the password to access the authentication LAN switch.

- **Available number of characters:** 4 - 32 characters
- **Unavailable characters:** " &

#### [EAP method]

Select the authentication method from EAP-MD5 or EAP-PEAP.

### 2.8.4 Configure the data encryption settings [Data encryption]

Click [Data encryption] on the “User mng.” page. (→For menu display and how to operate, refer to page 47, page 48)

The settings relating to the data encryption can be configured in this section.

Click the “+” mark on the left of the setup menu to expand the respective item, and enable detailed settings.

Click the “-” mark on the left of an expanded item to return to the screen displayed before the item was expanded.

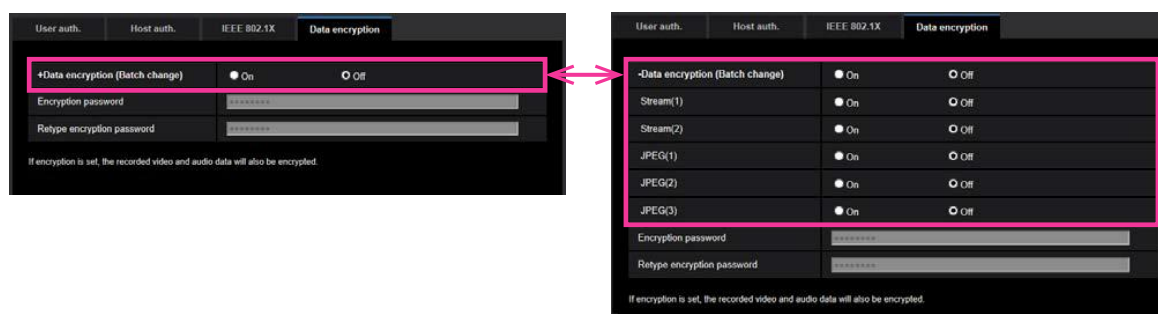

### [Data encryption (Batch change)]

Select “On” or “Off” to determine whether or not to activate data encryption.

- **On:** Activates data encryption. Encrypts Stream(1), Stream(2), JPEG(1), JPEG(2), JPEG(3), and “AAC-LC” audio.
- **Off:** Deactivates data encryption.
- **Default:** Off

### [Stream(1)], [Stream(2)], [JPEG(1)], [JPEG(2)], [JPEG(3)]

Select “On” or “Off” independently for Stream(1), Stream(2), JPEG(1), JPEG(2), and JPEG(3) to determine whether or not to activate data encryption.

- **Default:** Off

### [Encryption password], [Retype encryption password]

Set the password for data encryption.

- **Available number of characters:** 4 - 16 characters
- **Unavailable characters:** " &

## IMPORTANT

- The initial password is displayed in “MAC address” on the [Upgrade] screen. When using data encryption, make sure to change the password.
- If you set data encryption to “On”, “Stream(3)” and “Stream(4)” become “Off”.
- When the image capture mode is “3 mega pixel [4:3](30fps mode)” and data encryption is “On”, “2048x1536”, “JPEG” or stream cannot be selected.
- If you set data encryption to “On”, the upper limit of the possible bit rate for stream transmissions will be limited to maximum 16 Mbps.
- If you set data encryption to “On”, the snap shot button on the “Live” page will be hidden.
- If you set data encryption to “On” for JPEG, images cannot be monitored using a cellular phone/mobile terminal. Additionally, the [Refresh interval] pull-down on the “Live” page is not displayed for JPEG with data encryption set to “On”.
- The encrypted MP4 files and JPEG images cannot be viewed on the image playing screen in the browser. Download it to a PC and use the decryption tool to confirm it.  
For information about the decryption tool, refer to the “readme.txt” file in the supplied CD-ROM or our website (<https://security.panasonic.com/support/info/>).
- If you set data encryption to “On”, audio on the [Audio detection] screen will become inaudible.

### Note

- In order to view streams with data encryption set to “On”, you must install the viewer software.
- If you confirm streams with data encryption set to “On” on the “Live” page, password entry for decryption is displayed. If you correctly enter the “Encryption password” that was set, you will be able to view

## 2 Settings

images. When “Mic input”, “Interactive(Full-duplex)”, or “Interactive(Half-duplex)” is selected for [Audio transmission mode], only audio may be played until the password is entered.

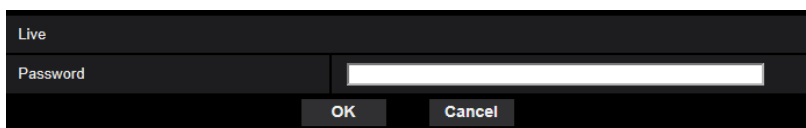

- Streams that have data encryption enabled for them are wrapped in < > in the [Live view] pull-down menu. Additionally, streams that have data encryption enabled for them are indicated by <Encrypted> in the setup menu pull-down menu.  
Example: When Stream(1) and JPEG(3) are data encrypted
- [Live view] pull-down menu on the “Live” page

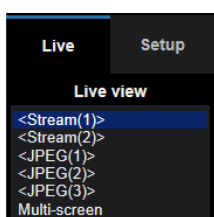

- Pull-down menu in the setup menu

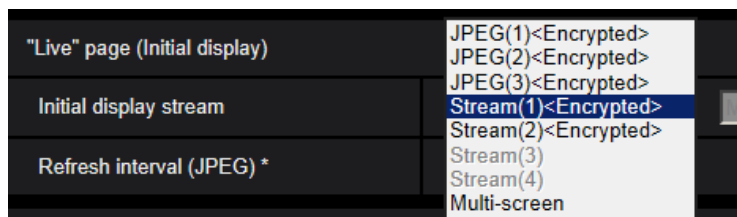

- When [Data encryption (Batch change)] is “On”, “AAC-LC” audio is data encrypted (“G.726” and “G.711” are not data encrypted). To encrypt both the image and audio, set [Data encryption (Batch change)] to “On” and set [Audio input encoding format] to “AAC-LC”.
- For encrypted MP4 files and JPEG images, you can use the decryption tool to confirm the images.



---

## 2.9 Configuring the network settings [Network]

The network settings can be configured on the “Network” page.  
The “Network” page has the [Network] tab and the [Advanced] tab.

### 2.9.1 Configure the network settings [Network]

Click the [Network] tab on the “Network” page. (→For menu display and how to operate, refer to page 47, page 48)

The following information is required to configure the network settings. Contact the network administrator or your Internet service provider.

- IP address
- Subnet mask
- Default gateway (when using the gateway server/router)
- HTTP port
- Primary DNS address, Secondary DNS address (when using DNS)

Network		Advanced		
IPv4 network				
Network Settings	Auto(Advanced) ▾			
IP address(IPv4)	192	168	0	10
Subnet mask	255	255	255	0
Default gateway	192	168	0	1
DNS	<input checked="" type="radio"/> Auto <input type="radio"/> Manual			
Primary server address	0	0	0	0
Secondary server address	0	0	0	0
IPv6 network				
Manual	<input checked="" type="radio"/> On <input type="radio"/> Off			
IP address(IPv6)	[Empty field]			
Default gateway	[Empty field]			
DHCPv6	<input type="radio"/> On <input checked="" type="radio"/> Off			
Primary DNS server address	[Empty field]			
Secondary DNS server address	[Empty field]			
Common				
HTTP port	80	(1-65535)		
Line speed	Auto ▾			
Max RTP packet size	<input type="radio"/> Unlimited(1500byte) <input checked="" type="radio"/> Limited(1280byte)			
HTTP max segment size(MSS)	Unlimited(1460byte) ▾			
Bandwidth control(bit rate)	Unlimited ▾			
Easy IP Setup accommodate period	<input type="radio"/> 20min <input checked="" type="radio"/> Unlimited			
FTP access to camera	<input checked="" type="radio"/> Allow <input type="radio"/> Forbid			
<b>Set</b>				

## IPv4 network

### [Network Settings]

Select the method of how to configure the IP address from the following.

- **Static:** The IP address is configured by entering manually on "IP address(IPv4)".
- **DHCP:** The IP address is configured using the DHCP function.
- **Auto(AutoIP):** The IP address is configured using the DHCP function. When the DHCP server is not found, the IP address is automatically configured.
- **Auto(Advanced):** Using the DHCP function, network address information is referred to, and an unused IP address is configured to the camera as a static IP address. The configured IP address is automatically determined within the subnet mask range by the camera. When the DHCP server is not found, the IP address is set to 192.168.0.10.
- **Default:** Auto(Advanced)

**Note**

- When “Auto(AutoIP)” is selected and the IP address cannot be obtained from the DHCP server, an IP address not used in the same network will be searched within 169.254.1.0 - 169.254.254.255.

**[IP address(IPv4)]**

When not using the DHCP function, enter the IP address of the camera. Do not enter an IP address already in use (for the PCs and the other network cameras).

- **Default:** 192.168.0.10

**Note**

- Multiple IP addresses are unavailable even when using the DHCP function. Refer to the network administrator for further information about the settings of the DHCP server.

**[Subnet mask]**

When not using the DHCP function, enter the subnet mask of the camera.

- **Default:** 255.255.255.0

**[Default gateway]**

When not using the DHCP function, enter the default gateway of the camera.

- **Default:** 192.168.0.1

**Note**

- Multiple IP addresses for the default gateway are unavailable even when using the DHCP function. Refer to the network administrator for further information about the settings of the DHCP server.

**[DNS]**

Determine how to set the address of the DNS server by selecting “Auto” (obtain the address automatically) or “Manual” (enter the address of the DNS server). When “Manual” is selected, it is necessary to configure the settings for the DNS.

When using the DHCP function, it is possible to obtain the DNS address automatically by selecting “Auto”. Refer to the network administrator for further information about the settings.

- **Default:** Auto

**[Primary server address], [Secondary server address]**

When “Manual” is selected for “DNS”, enter the IP address of the DNS server.

Refer to the network administrator about the IP address of the DNS server.

## IPv6 network

**[Manual]**

Select “On” or “Off” to determine whether or not to manually configure the IP address for IPv6 network (IPv6 address).

- **On:** Enter an IPv6 address manually.
- **Off:** Manual entry of an IPv6 address will become unavailable.
- **Default:** Off

**[IP address(IPv6)]**

When “On” is selected for “Manual”, manual entry of the IPv6 address is required. Do not enter an address already in use.

**Note**

- When connecting to the manually configured IPv6 address beyond the router, use an IPv6 compatible router and turn on the automatic IPv6 address assignment function. In this case, it is necessary to

configure IPv6 address including prefix information provided from the IPv6 compatible router. Refer to the manuals provided with the router for further information.

### [Default gateway]

When “On” is selected for “Manual” of IPv6 network, enter the default gateway of IPv6 network of the camera.

- **Default:** None (blank)

### [DHCPv6]

Select “On” or “Off” to determine whether or not to use the IPv6 DHCP function.

Configure the DHCP server not to assign the same IP addresses used for the other network cameras and PCs whose IP address is unique. Refer to the network administrator for further information about the settings of the server.

- **Default:** Off

### [Primary DNS server address], [Secondary DNS server address]

Enter the IPv6 address of the DNS server. Refer to the network administrator about the IPv6 address of the DNS server.

## Common

### [HTTP port]

Assign the port numbers independently.

- **Available port number:** 1 - 65535
- **Default:** 80

The following port numbers are unavailable since they are already in use.

20, 21, 23, 25, 42, 53, 67, 68, 69, 110, 123, 161, 162, 443, 554, 995, 10669, 10670, 59000 - 61000

### [Line speed]

Select the line speed for data transmission from the following. It is recommended to use with the default “Auto”.

- **Auto:** Line speed will be applied automatically.
- **100M-Full:** 100 Mbps full-duplex
- **100M-Half:** 100 Mbps half-duplex
- **10M-Full:** 10 Mbps full-duplex
- **10M-Half:** 10 Mbps half-duplex
- **Default:** Auto

### [Max RTP packet size]

Select “Unlimited(1500byte)” or “Limited(1280byte)” to determine whether or not to restrict the RTP packet size when viewing images from the camera using the RTP protocol. It is recommended to use with the default “Unlimited(1500byte)”.

When the RTP packet size is restricted in the network line in use, select “Limited(1280byte)”. Refer to the network administrator for further information about the maximum packet size in the network line.

- **Default:** Unlimited(1500byte)

### [HTTP max segment size(MSS)]

Select “Unlimited(1460byte)”, “Limited(1280byte)”, or “Limited(1024byte)” to determine whether or not to restrict the maximum segment size (MSS) when viewing images from the camera using the HTTP protocol. We recommended that you use this feature with the default setting.

When the MSS is restricted in the network line in use, select “Limited(1024byte)” or “Limited(1280byte)”. Refer to the network administrator for further information about the MSS in the network line.

- **Default:** Unlimited(1460byte)

**[Bandwidth control(bit rate)]**

Select the total bit rate for data transmission from the following.

Unlimited/ 64kbps/ 128kbps/ 256kbps/ 384kbps/ 512kbps/ 768kbps/ 1024kbps/ 2048kbps/ 4096kbps/  
6144kbps/ 8192kbps/ 10240 kbps/ 15360 kbps/ 20480 kbps/ 25600 kbps/ 30720kbps/ 35840kbps/ 40960 kbps/  
51200kbps

- **Default:** Unlimited

**Note**

- When selecting “64kbps”, select “Off” for “Audio transmission mode” on the [Audio] tab. (→page 146)
- Select “128kbps” or a faster rate to carry out the live transmission of JPEG images and the FTP periodic image transmission simultaneously.
- When “Bandwidth control(bit rate)” is set low, taking a picture using the snap shot button may not function depending on the usage environment. In this case, select “JPEG” on the “Live” page and take a picture with the snap shot button using the lowest possible image capture size.

**[Easy IP Setup accommodate period]**

Select “20min” or “Unlimited” to determine how long the network setting operation using the Panasonic “IP Setting Software” can be allowed.

- **20min:** The network setting operation using the Panasonic “IP Setting Software” are allowed for 20 minutes since the camera starts up.
- **Unlimited:** The network setting operation using the Panasonic “IP Setting Software” are allowed without time limitation.
- **Default:** 20min

**Note**

- The camera information display using the Panasonic “IP Setting Software” is allowed without time limitation, and camera images can be opened.
- Refer to the network administrator for the addresses of each server.
- The port forwarding function changes a global IP address to a private IP address, and “Static IP masquerade” and “Network Address Translation (NAT)” have this function. This function is to be set in a router.

## 2 Settings

- To access the camera via the Internet by connecting the camera to a router, it is necessary to assign a respective HTTP port number for each camera and address translation by using the port forwarding function of the router. For further information, refer to the operating instructions of the router in use.

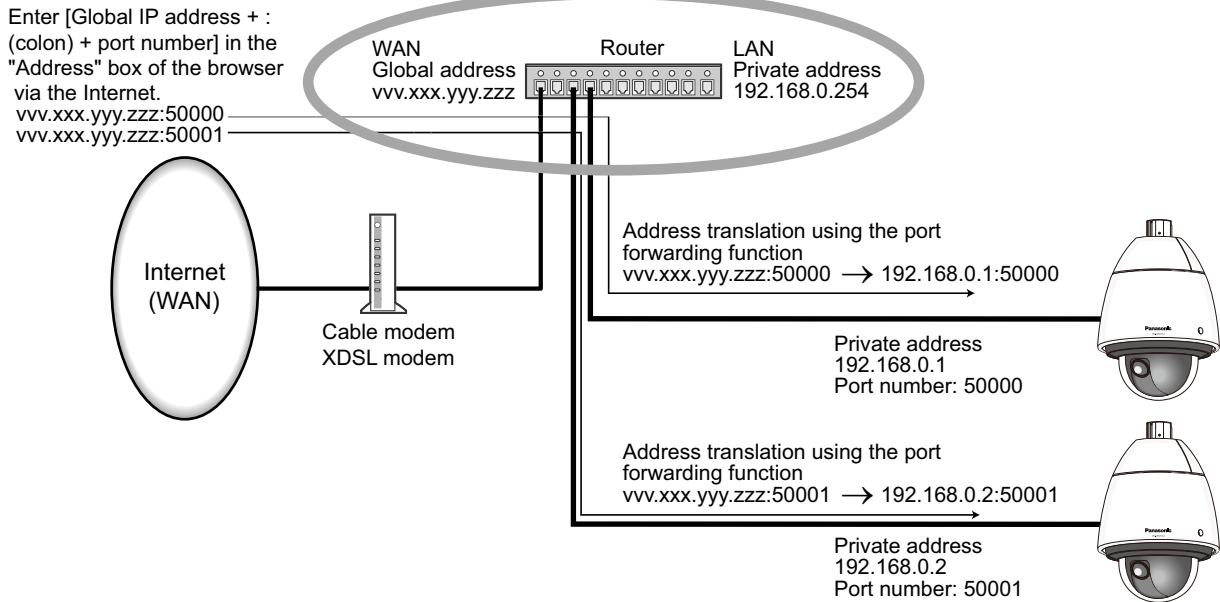

### [FTP access to camera]

Select "Allow" or "Forbid" to determine whether to allow or forbid the FTP access to camera.

- Default:** Forbid

## 2.9.2 Configure advanced network settings [Advanced]

Click the [Advanced] tab on the "Network" page. (→For menu display and how to operate, refer to page 47, page 48)

The settings related to SMTP (E-mail), FTP, NTP, UPnP, HTTPS, DDNS, SNMP, QoS can be configured in this section.

You can move to the setting page of a setting item by clicking the corresponding link for that setting item.

## 2.9.2.1 Configure the settings related to sending E-mails

Network		Advanced	
<a href="#">SMTP(E-mail)</a>   <a href="#">FTP</a>   <a href="#">NTP</a>   <a href="#">UPnP</a>   <a href="#">HTTPS</a>   <a href="#">DDNS</a>   <a href="#">SNMP</a>   <a href="#">QoS</a>			
SMTP(E-mail)			
E-mail notification	<input type="radio"/> On <input type="radio"/> Off		
Alarm image attachment	<input type="radio"/> On <input type="radio"/> Off		
Image capture size	JPEG(2) (640x360)		
SMTP server address	<input type="text"/> Example of entry: 192.168.0.10		
SMTP port	25 (1-65535)		
POP server address	<input type="text"/> Example of entry: 192.168.0.10		
Authentication	Type	<input type="radio"/> None <input type="radio"/> POP before SMTP <input type="radio"/> SMTP	
	User name	<input type="text"/>	
	Password	<input type="text"/>	
Sender's E-mail address	<input type="text"/>		
SSL	<input type="radio"/> On <input type="radio"/> Off		
Destination of notification	Destination E-mail address		
Address 1	<input type="text"/> Delete		
	<input type="checkbox"/> Terminal 1 <input type="checkbox"/> Terminal 2 <input type="checkbox"/> Terminal 3 <input type="checkbox"/> VMD <input type="checkbox"/> Command alarm <input type="checkbox"/> Audio detection <input type="checkbox"/> Diag. <input type="checkbox"/> Auto track		
Address 2	<input type="text"/> Delete		
	<input type="checkbox"/> Terminal 1 <input type="checkbox"/> Terminal 2 <input type="checkbox"/> Terminal 3 <input type="checkbox"/> VMD <input type="checkbox"/> Command alarm <input type="checkbox"/> Audio detection <input type="checkbox"/> Diag. <input type="checkbox"/> Auto track		
Address 3	<input type="text"/> Delete		
	<input type="checkbox"/> Terminal 1 <input type="checkbox"/> Terminal 2 <input type="checkbox"/> Terminal 3 <input type="checkbox"/> VMD <input type="checkbox"/> Command alarm <input type="checkbox"/> Audio detection <input type="checkbox"/> Diag. <input type="checkbox"/> Auto track		
Address 4	<input type="text"/> Delete		
	<input type="checkbox"/> Terminal 1 <input type="checkbox"/> Terminal 2 <input type="checkbox"/> Terminal 3 <input type="checkbox"/> VMD <input type="checkbox"/> Command alarm <input type="checkbox"/> Audio detection <input type="checkbox"/> Diag. <input type="checkbox"/> Auto track		
E-mail subject	<input type="checkbox"/> Use the camera title <input type="checkbox"/> Cause of alarm <input type="text"/>		
E-mail body	<input checked="" type="checkbox"/> Cause of alarm <input checked="" type="checkbox"/> Occurrence time The %p% alarm was occurred at %%.		
Terminal name			
Terminal 1 (Up to 10 characters)	<input type="text"/> Terminal1		
Terminal 2 (Up to 10 characters)	<input type="text"/> Terminal2		
Terminal 3 (Up to 10 characters)	<input type="text"/> Terminal3		
<b>Set</b>			

### [E-mail notification]

Select “On” or “Off” to determine whether or not to provide notification by E-mail according to the settings for the “Alarm” and “Diag.” checkboxes of “Destination of notification” below.

- When an alarm is detected (“Alarm”)
- When a notification of the remaining capacity of the SD memory card has been provided (“Diag.”)
- When the SD memory card has become full (“Diag.”)
- When the SD memory card cannot be recognized (“Diag.”)
- **Default:** Off

### [Alarm image attachment]

Select “On” or “Off” to determine whether or not to attach an image to the E-mail to be sent when an alarm is detected.

- **Default:** Off

### [Image capture size]

Select the image capture size of images attached to an alarm E-mail from the following.

JPEG(1)/JPEG(2)/JPEG(3)

- **Default:** JPEG(2)

### [SMTP server address]

Enter the IP address or the host name of the SMTP server used to send E-mails.

- **Available number of characters:** 1 - 128 characters
- **Available characters:** Alphanumeric characters, the colon (:), the period (.), the underscore (\_), and the hyphen (-).

### [SMTP port]

Enter the port number to which E-mails are sent.

- **Available port number:** 1-65535
- **Default:** 25

The following port numbers are unavailable since they are already in use.

20, 21, 23, 42, 53, 67, 68, 69, 80, 110, 123, 161, 162, 443, 995, 10669, 10670

### [POP server address]

When “POP before SMTP” is selected for “Type”, enter the IP address or the host name of the POP server.

- **Available number of characters:** 1 - 128 characters
- **Available characters:** Alphanumeric characters, the colon (:), the period (.), the underscore (\_), and the hyphen (-).

### **IMPORTANT**

- When entering the host name for “SMTP server address” or “POP server address”, it is necessary to configure the DNS settings on the [Network] tab of the “Network” page. (→page 185)

### [Authentication]

- **Type**

Select the authentication method to send E-mails from the following.

- **None:** It is not necessary to clear any authentication to send E-mails.
- **POP before SMTP:** It is necessary to first clear the POP server authentication to use the SMTP server to send E-mails.
- **SMTP:** It is necessary to clear the SMTP server authentication to send E-mails.
- **Default:** None



**Note**

- When you don't know the authentication method to send E-mails, refer to the network administrator.

- **User name**

Enter the user name to access the server.

- **Available number of characters:** 0 - 32 characters
- **Unavailable characters:** " & ; \

- **Password**

Enter the password to access the server.

- **Available number of characters:** 0 - 32 characters
- **Unavailable characters:** " &

**[Sender's E-mail address]**

Enter the E-mail address of a sender.

The entered E-mail address will be displayed in the "From" (sender) line of the sent E-mails.

- **Available number of characters:** 3 - 128 characters
- **Available characters:** Alphanumeric characters, the at sign (@), the period (.), the underscore (\_), and the hyphen (-).

**[SSL]**

Select "On" if you want to use SSL encryption when sending E-mail notifications for alarm occurrences or the "Diag." function. When you select "On", the authentication method will be set to "SMTP". Set the user name and the password used for authentication.

- **Default:** Off

**Note**

- Some SMTP servers may not support SSL.
- SSL supports SMTP over SSL, but STARTTLS is not supported.
- When "On" is selected, the SMTP port number may need to be set to 465. Ask your Internet service provider for the appropriate settings.

**[Address 1] - [Address 4]**

Enter the destination E-mail address. Up to 4 destination E-mail addresses can be registered.

- **Available number of characters:** 3 - 128 characters
- **Available characters:** Alphanumeric characters, the at sign (@), the period (.), the underscore (\_), and the hyphen (-).  
To delete the registered address, click the [Delete] button respective to the desired address.
- **Terminal 1:** Notify by e-mail when an alarm occurs in Terminal 1.
- **Terminal 2:** Notify by e-mail when an alarm occurs in Terminal 2.
- **Terminal 3:** Notify by e-mail when an alarm occurs in Terminal 3.
- **VMD:** Notify by e-mail when motion is detected.
- **Audio detection:** Notify by e-mail when audio detection has occurred.
- **Command alarm:** Notify by e-mail when a command alarm is entered.
- **Diag.:**
  - When a notification of the remaining capacity of SD memory card has been provided
  - When the SD memory card has become full
  - When the SD memory card cannot be recognized
- **Auto track:** Notify by e-mail when an auto track alarm occurs.

**Note**

- In the diagnostic e-mail notification sent when you have checked the destination of notification [Diag.] field, the contents of the [E-mail subject] and [E-mail body] which are set later are not changed.

### [E-mail subject]

Enter the E-mail subject.

- **Available number of characters:** 0 - 50 characters
- **Use the camera title:** The camera title will be displayed in the e-mail subject.
- **Cause of alarm:** Adds the cause of alarm to the E-mail subject.

### [E-mail body]

Enter the E-mail body.

- **Available number of characters:** 0 - 200 characters
- **Cause of alarm:** The cause of alarm %p% is added in the e-mail body. %p% is replaced by the cause of alarm and sent.
  - For VMD alarm: "VMD"
  - For terminal alarm: Terminal name set in "Terminal 1", "Terminal 2", and "Terminal 3" of "Terminal name". (Example: If the name of Terminal 1 is "Terminal1", it is "Terminal1")
  - For command alarm: "CMD"
  - For audio detection alarm: "Audio detection"
  - For Auto track alarm: "Auto track"
- **Occurrence time:** The time of occurrence %t% will be added to the e-mail body. %t% will be replaced by the time of occurrence of the alarm (HH:MM:SS) and sent.
- **Default:**
  - Cause of alarm: Checked
  - Occurrence time: Checked
  - E-mail body: The %p% alarm was occurred at %t%.

### Note

- Notification E-mail will be sent with the message "The capacity of the SD memory card is full." when the SD memory card has become full, or "The SD memory card cannot be detected." when mounting of the SD memory card failed.
- Entering alternative text into the E-mail body automatically adds the event or time when an alarm occurs.

Alternative text cause of alarm: %p%, occurrence time: %t%  
(Examples of use)  
After setting the following characters in the E-mail body, there is a VMD alarm occurrence at the time 19:13:24.  
E-mail body settings: %p% alarm occurred at %t%.  
Sent E-mail body: "A "VMD" alarm occurred at 19:13:24."  
When the body of the email is empty, the language that the email is sent in is determined by "Menu language" of "Basic". If "Japanese" is specified, email is sent in Japanese. If another language is specified, email is sent in English.

### [Terminal 1 (Up to 10 characters)]

Enter the name of Terminal 1 used in the cause of alarm in the e-mail body.

- **Unavailable characters:** " &
- **Default:** Terminal1

### [Terminal 2 (Up to 10 characters)]

Enter the name of Terminal 2 used in the cause of alarm in the e-mail body.

- **Unavailable characters:** " &
- **Default:** Terminal2

### [Terminal 3 (Up to 10 characters)]

Enter the name of Terminal 3 used in the cause of alarm in the e-mail body.

- **Unavailable characters:** " &
- **Default:** Terminal3

### Example of e-mail notification

An e-mail format in which the camera title check box is specified in the e-mail subject and the cause of alarm/ occurrence time are specified in the e-mail body

Example e-mail:

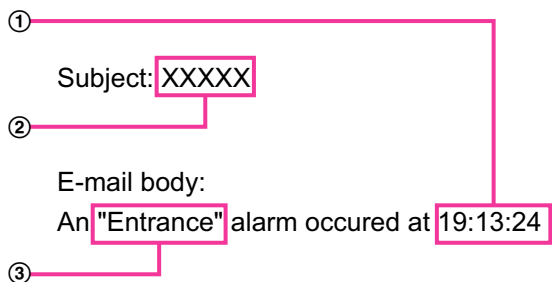

- ① The alarm occurrence time is assigned.
- ② The camera title is used as the e-mail subject.
- ③ The name set for Terminal names 1 to 3, which is the cause of alarm, is assigned to the name.

## 2.9.2.2 Configure the settings related to FTP transmission

### FTP

#### [Alarm image FTP transmission]

Select “On” or “Off” to determine whether or not to transmit the alarm image to the FTP server.

- **Default:** Off

#### [Directory name]

Enter the directory name where the alarm images are to be saved.

For example, enter “/ALARM” to designate the directory “ALARM” under the root directory of the FTP server.

- **Available number of characters:** 1 - 256 characters
- **Unavailable characters:** " & ;

**[File name]**

Enter the file name used for the alarm image to be transmitted to an FTP server. The file name will be as follows.

File name: ["Entered file name" + "Time and date (year/ month/ day/ hour/ minute/ second)"] + "Serial number"

- **Available number of characters:** 1 - 32 characters
- **Unavailable characters:** " & \* / : ; < > ? \ |
- **Terminal 1:** Transmit the image to the FTP server when an alarm occurs in Terminal 1.
- **Terminal 2:** Transmit the image to the FTP server when an alarm occurs in Terminal 2.
- **Terminal 3:** Transmit the image to the FTP server when an alarm occurs in Terminal 3.
- **VMD:** Transmit the image to the FTP server when motion is detected.
- **Audio detection:** Transmit the image to the FTP server when audio detection occurs.
- **Command alarm:** Transmit the image to the FTP server when a command alarm is entered.
- **Auto track:** Transmit the image to the FTP server when an auto track alarm occurs.

**[FTP transmission retry]**

Select "On" or "Off" to determine whether or not to resend failed FTP transmissions.

- **On:** If transmission fails, transmissions are resent until they are successfully sent.
- **Off:** If transmission fails, the image that failed to be sent is discarded and the next image is sent.
- **Default:** Off

**[Pre alarm]**• **Transmission interval**

Select the update interval of images before an alarm occurs from the following.

0.1fps/ 0.2fps/ 0.33fps/ 0.5fps/ 1fps

- **Default:** 1fps

• **Maximum number of images**

Select the number of images to be transmitted from the following.

0pics/ 1pic/ 2pics/ 3pics/ 4pics/ 5pics/ 6pics\*/ 7pics\*/ 8pics\*/ 9pics\*/ 10pics\*/ 20pics\*/ 30pics\*/ 40pics\*/ 50pics\*

- **Default:** 0 pics

• **Recording duration**

The recording duration, which changes according to the configured "Transmission interval" and "Maximum number of images", of images recorded before an alarm occurs is displayed.

**Note**

- When "JPEG(1)" is selected for the capture size of the image to be transmitted, pre alarm is unavailable if the image capture size of "JPEG(1)" is either "2048x1536" or "1920x1080".
- When "On" is selected for "Image compression rate upon alarm detection", only post alarm recorded images are compressed. Compression is not applied to pre alarm recorded images.
- When a selection with an asterisk (\*) on the right of it is selected for "Maximum number of images" of "Pre alarm", the specified number of images may not be able to be sent depending on the image capture size and image quality. The following table shows the maximum number of images that can be sent for pre alarm.

	Image quality									
	0	1	2	3	4	5	6	7	8	9

Image capture size	1280x960	5	6	7	8	10	10	10	20	30	40
	1280x720	7	8	10	10	10	20	20	30	40	50
	800x600	9	10	10	20	20	30	30	50	50	50
	VGA	10	20	20	30	30	40	50	50	50	50
	640x360	20	30	40	50	50	50	50	50	50	50
	400x300	30	30	40	50	50	50	50	50	50	50
	QVGA	40	50	50	50	50	50	50	50	50	50
	320x180	50	50	50	50	50	50	50	50	50	50

**[Post alarm]**

- **Transmission interval**  
Select the transmission interval for the alarm image transmission to the FTP server from the following.  
0.1fps/ 0.2fps/ 0.33fps/ 0.5fps/ 1fps
  - **Default:** 1fps
- **Number of images**  
Select the number of images to be transmitted from the following.  
1pic/ 2pics/ 3pics/ 4pics/ 5pics/ 6pics/ 7pics/ 8pics/ 9pics/ 10pics/ 20pics/ 30pics/ 50pics/ 100pics/ 200pics/ 300pics/ 500pics/ 1000pics/ 1500pics/ 2000pics/ 3000pics
  - **Default:** 100pics
- **Recording duration**  
Approximate time to be taken to save the set “Number of images” with the set “Transmission interval” will be displayed.

**[Image capture size]**

- Select the image capture size of images transmitted when an alarm occurs from the following.  
JPEG(1)/JPEG(2)/JPEG(3)
- **Default:** JPEG(2)

**FTP periodic image transmission**

**[FTP periodic image transmission]**

Select “On” or “Off” to determine whether or not to transmit images using the FTP periodic image transmission function.  
When “On” is selected, it is necessary to configure the settings of the FTP server.

- **Default:** Off

**IMPORTANT**

- When using FTP periodic image transmission, it is necessary to configure the schedule settings of FTP periodic image transmission on the [Schedule] tab of the “Schedule” page. (→page 232)

**[Directory name]**

Enter the directory name where the images are to be saved.  
For example, enter “/img” to designate the directory “img” under the root directory of the FTP server.

- **Available number of characters:** 1 - 256 characters
- **Unavailable characters:** " & ;
- **Default:** None (blank)

**[File name]**

Enter the file name (name of the image file to be transmitted) and select the naming option from the following.

- **Name w/time&date:** File name will be ["Entered file name" + "Time and date (year/ month/ day/ hour/ minute/ second)" + "Serial number (starting from 00)"].
- **Name w/o time&date:** File name will be the characters entered for "File name" only. When "Name w/o time&date" is selected, the file will be overwritten each time a file is newly transmitted.
- **Available number of characters:** 1 - 32 characters
- **Unavailable characters:** " & ; : / \* < > ? \ |
- **Default:** None (blank)

**Note**

- When "Name w/time&date" is selected, the file name will be ["Entered file name" + "Time and date (year/ month/ day/ hour/ minute/ second)" + "Serial number (starting from 00)"] + "s" during summer time.

**[Transmission interval]**

Select the interval for the FTP periodic image transmission from the following.

1s/ 2s/ 3s/ 4s/ 5s/ 6s/ 10s/ 15s/ 20s/ 30s/ 1min/ 2min/ 3min/ 4min/ 5min/ 6min/ 10min/ 15min/ 20min/ 30min/ 1h/ 1.5h/ 2h/ 3h/ 4h/ 6h/ 12h/ 24h

- **Default:** 1s

**[Image capture size]**

Select the image capture size of images to be transmitted from the following.

JPEG(1)/JPEG(2)/JPEG(3)

- **Default:** JPEG(2)

**[FTP server address]**

Enter the IP address or the host name of the FTP server.

- **Available number of characters:** 1 - 128 characters
- **Available characters:** Alphanumeric characters, the colon (:), the period (.), the underscore (\_), and the hyphen (-).

**IMPORTANT**

- When entering the host name for "FTP server address", it is necessary to configure the DNS settings on the [Network] tab of the "Network" page. (→page 185)

**[User name]**

Enter the user name (login name) to access the FTP server.

- **Available number of characters:** 1 - 32 characters
- **Unavailable characters:** " & ; ; \

**[Password]**

Enter the password to access the FTP server.

- **Available number of characters:** 0 - 32 characters
- **Unavailable characters:** " &

**[Control port]**

Enter a control port number to be used for the FTP server.

- **Available port number:** 1-65535
- **Default:** 21

The following port numbers are unavailable since they are already in use.

20, 23, 25, 42, 53, 67, 68, 69, 80, 110, 123, 161, 162, 443, 995, 10669, 10670

### [FTP mode]

Select “Passive” or “Active” for the FTP mode.

Normally, select “Passive”. When it is impossible to connect after select “Passive”, try to connect after selecting “Active”.

- **Default:** Passive

### 2.9.2.3 Configure the settings relating to the NTP server

The settings relating to the NTP server such as the NTP server address, port number, etc. can be configured on this page.

#### **IMPORTANT**

- Use an NTP server when the more accurate time & date setting is required for the system operation.

NTP	
Time adjustment	<input type="radio"/> Manual <input checked="" type="radio"/> Synchronization with NTP server
NTP server address setting	<input type="text"/>
NTP server address	<input type="text"/> Example of entry: 192.168.0.10
NTP port	<input type="text"/> 123 (1-65535)
Time adjustment interval	<input type="text"/>

### [Time adjustment]

Select the time adjustment method from the following. Time adjusted by the selected method will be used as the standard time of the camera.

- **Manual:** Time set on the [Basic] tab on the “Basic” page will be used as the standard time of the camera.
- **Synchronization with NTP server:** Time automatically adjusted by synchronizing with the NTP server will be used as the standard time of the camera.
- **Default:** Manual

### [NTP server address setting]

When “Synchronization with NTP server” is selected for “Time adjustment”, select the method of how to obtain the NTP server address from the following.

- **Auto:** Obtains the NTP server address from the DHCP server.
- **Manual:** The NTP server address will be entered manually on “NTP server address”.
- **Default:** Manual

#### **IMPORTANT**

- When obtaining the NTP server address from the DHCP server, it is necessary to select “DHCP”, “Auto(AutoIP)”, or “Auto(Advanced)” for “Network Settings” on the [Network] tab of the “Network” page. (→page 185)

### [NTP server address]

When “Manual” is selected for “NTP server address setting”, enter the IP address or the host name of the NTP server.



- **Available number of characters:** 1 - 128 characters
- **Available characters:** Alphanumeric characters, the colon (:), the period (.), the underscore (\_), and the hyphen (-).
- **Default:** None (blank)

### **IMPORTANT**

- When entering the host name for “NTP server address”, it is necessary to configure the DNS settings on the [Network] tab of the “Network” page. (→page 185)

### **[NTP port]**

Enter a port number of the NTP server.

- **Available port number:** 1 - 65535
- **Default:** 123

The following port numbers are unavailable since they are already in use.

20, 21, 23, 25, 42, 53, 67, 68, 69, 80, 110, 161, 162, 443, 995, 10669, 10670

### **[Time adjustment interval]**

Select an interval (1 - 24 hours: in 1 hour intervals) of synchronization with the NTP server.

- **Default:** 1h

## 2.9.2.4 Configure the UPnP settings

This camera support UPnP (Universal Plug and Play). By using the UPnP function, it becomes possible to configure the following automatically.

- Configuration of the port forwarding function of the router (However, a router supporting UPnP is required.) This configuration is useful when accessing the camera via the Internet, or from a cellular phone/mobile terminal.
- Automatic refreshment of the shortcut to the camera that is created on the [Network] folder of the PC even when the IP address of the camera changes.

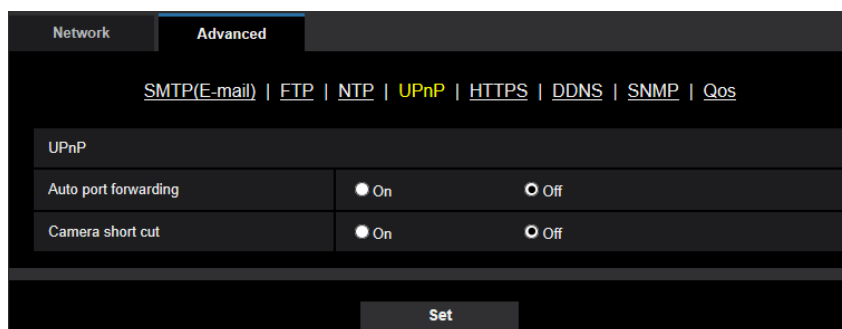

### **[Auto port forwarding]**

Select “On” or “Off” to determine whether or not to use the port forwarding function of the router.

To use the port forwarding function, the router in use must support UPnP and the UPnP must be enabled.

- **Default:** Off

### **Note**

- Due to port forwarding, the port number may sometimes be changed. When the number is changed, it is necessary to change the port numbers registered in the PC and recorders, etc.
- The UPnP function is available when the camera is connected to the IPv4 network. IPv6 is not supported.

- To check if auto port forwarding is properly configured, click the [Status] tab on the “Maintenance” page, and check that the “Enable” is displayed for “Status” of “UPnP”. (→page 241)  
When “Enable” is not displayed, refer to “Cannot access the camera via the Internet.” in the “3.3 Troubleshooting” section. (→page 259)

### **[Camera short cut]**

Select whether or not to create the shortcut to the camera on the [Network] folder of the PC. When creating the shortcut, select “On”.

To use the shortcut function to the camera, enable the UPnP function on the PC in advance.

- **Default:** Off

### **Note**

- To display the shortcut to the camera on the [Network] folder of the PC, it is necessary to add the Windows component. Refer to the following to enable the UPnP function.

#### **For Windows 7**

[Start] → [Control Panel] → [Network and Internet] → [Network and Sharing Center] → select [Turn on network discovery] of [Network discovery] of [Change advanced sharing settings] → click [Save changes] → Complete

#### **For Windows 8.1 and Windows 8**

Right-click [Start] → select [Control Panel] → [Network and Internet] → [Network and Sharing Center] → select [Turn on network discovery] of [Network discovery] of [Change advanced sharing settings] → click [Save changes] → Complete

#### **For Windows 10**

[Start] → [Settings] → [NETWORK & INTERNET] → [Ethernet] → [Network and Sharing Center] → select [Turn on network discovery] of [Network discovery] of [Change advanced sharing settings] → click [Save changes] → Complete

## 2.9.2.5 Configure the HTTPS settings

It is possible to enhance the network security by encrypting the access to cameras using the HTTPS function. Refer to page 209 for how to configure the HTTPS settings.

The screenshot shows a web interface for configuring HTTPS settings. The 'Advanced' tab is selected, and the 'HTTPS' section is active. The settings are as follows:

Network		Advanced	
<a href="#">SMTP(E-mail)</a>   <a href="#">FTP</a>   <a href="#">NTP</a>   <a href="#">UPnP</a>   <a href="#">HTTPS</a>   <a href="#">DDNS</a>   <a href="#">SNMP</a>   <a href="#">QoS</a>			
HTTPS			
Connection	HTTP		
Select certificate	Pre-installed		
HTTPS port	443 (1-65535)		
Pre-installed certificate			
Download root certificate	Execute		
CA Certificate			
CRT key generate	Execute		
Generate Certificate Signing Request	Execute		
CA Certificate install	<input type="text"/> Browse...		Execute
Information	Invalid	Confirm	Delete
Set			

### [HTTPS - Connection]

Select the protocol used to connect the camera.

- **HTTP:** Only the HTTP connection is available.
- **HTTPS:** Only the HTTPS connection is available.
- **Default:** HTTP

### [HTTPS - Select certificate]

Select the certificate to be used with HTTPS.

- **Pre-installed:** Select a pre-installed certificate.
- **CA:** Select a CA certificate. Only displayed when the CA Certificate is installed.
- **Default:** Pre-installed

### [HTTPS - HTTPS port]

Designate the HTTPS port number to be used.

- **Available port number:** 1 - 65535
- **Default:** 443

The following port numbers are unavailable since they are already in use.

20, 21, 23, 25, 42, 53, 67, 68, 69, 80, 110, 123, 161, 162, 554, 995, 10669, 10670, 59000-61000

### [Pre-installed certificate - Download root certificate]

Click the [Execute] button to download the root certificate for the pre-installed certificate. By installing the root certificate to your PC, you can get signature verification for the pre-installed certificate.

### **[CRT key generate]**

CRT key (SSL encryption key) used for the HTTPS protocol is generated. To generate the CRT key, click the [Execute] button to display “CRT key generate” dialog box.

### **[CA Certificate - Generate Certificate Signing Request]**

When using the CA certificate issued by CA (Certificate Authority) as the CA certificate used for the HTTPS protocol, the CSR (Certificate Signing Request) will be generated.

To generate the CSR, click the [Execute] button to display the “CA Certificate - Generate Certificate Signing Request” dialog window.

### **[CA Certificate - CA Certificate install]**

Installs the CA certificate issued by CA (Certificate Authority) and displays the information of the installed CA certificate.

To install the CA certificate, click the [Browse...] button to display the [Open] dialog box, and select the file of the CA certificate issued by CA, and click the [Execute] button.

### **[CA Certificate - Information]**

Displays the information of the CA certificate.

When the [Confirm] button is clicked, the registered information of the installed CA certificate will be displayed in the “CA Certificate - Confirm” dialog box. If the CA certificate is not installed, the content of the generated CSR file will be displayed.

When the [Delete] button is clicked, the installed CA certificate will be deleted.

### **IMPORTANT**

- Before deleting the valid CA certificate, confirm that there is a backup file of the CA certificate on the PC or another media. The backup file of the CA certificate will be required when installing the CA certificate again.

### **Note**

- After changing the connection setting, access the camera again by after waiting a while according to the changed setting (“http://IP address of the camera” or “https://IP address of the camera”).
- When the camera is accessed using the HTTPS protocol, the refresh interval and frame rate of images may be lower.
- When the camera is accessed using the HTTPS protocol, it may take time to display images.
- When the camera is accessed using the HTTPS protocol, the images may be distorted or audio may be interrupted.
- The maximum number of concurrent access user varies depending on the maximum image size and transmission format.

## **2.9.2.6 Configure the settings relating to DDNS**

To access this camera via the Internet, it is necessary to configure the settings for the DDNS function.

Refer to page 226 for how to configure the settings relating to DDNS.

The screenshot shows the DDNS configuration interface. At the top, there are tabs for 'Network' and 'Advanced', with 'Advanced' selected. Below the tabs, there are links for 'SMTP(E-mail)', 'FTP', 'NTP', 'UPnP', 'HTTPS', 'DDNS', 'SNMP', and 'Qos'. The 'DDNS' section contains the following fields:

Area	Global
Service	Viewnetcam.com
Personal(Camera) URL	
Your Account Link	
Access interval	1h
Global IP Address Notification Method	<input type="radio"/> Normal <input checked="" type="radio"/> Advanced

At the bottom of the form is a 'Set' button.

### [Area]

Select the region where the camera is installed.  
Japan/Global

### Note

- If the camera is used in Japan, select “Japan”. If the camera is used outside of Japan, select “Global”. The “Viewnetcam.com” service that is displayed when “Global” is selected cannot be used in Japan.

### [Service]

Select the DDNS service to determine whether or not to use DDNS.

- **Off:** Does not use the DDNS function.
- **Viewnetcam.com:** Uses the “Viewnetcam.com” service.
- **Dynamic DNS Update:** Uses Dynamic DNS Update (RFC2136 compliant) without the DHCP cooperation.
- **Dynamic DNS Update(DHCP):** Uses Dynamic DNS Update (RFC2136 compliant) with the DHCP cooperation.
- **Default:** Off

### Note

- When using Dynamic DNS Update (RFC2136 compliant), refer to the network administrator for whether or not to cooperate with the DHCP.

## 2.9.2.7 Configure the settings relating to SNMP

The settings relating to SNMP can be configured on this page. It is possible to check the status of the camera by connecting to the SNMP manager. When using the SNMP function, contact the network administrator.

The screenshot shows a configuration page with a dark theme. At the top, there are tabs for 'Network' and 'Advanced'. Under 'Advanced', there are sub-tabs for 'SMTP(E-mail)', 'FTP', 'NTP', 'UPnP', 'HTTPS', 'DDNS', 'SNMP', and 'QoS'. The 'SNMP' sub-tab is selected. The main area contains several rows of configuration options:

- SNMP version:** A dropdown menu showing 'SNMPv1/v2'.
- SNMPv1/v2:** A 'Community' field with an empty text input.
- SNMPv3:** A section with four sub-rows:
  - User name (1 to 32 characters):** An empty text input.
  - Authentication:** Two radio buttons, 'MD5' (selected) and 'SHA1'.
  - Encryption method:** Two radio buttons, 'DES' (selected) and 'AES'.
  - Password (8 to 16 characters):** An empty text input.
- System name:** An empty text input.
- Location:** An empty text input.
- Contact:** An empty text input.

At the bottom of the form is a 'Set' button.

### [SNMP version]

Select the SNMP version to be used.

- **SNMPv1/v2:** SNMPv1/v2 is activated.
- **SNMPv3:** SNMPv3 is activated.
- **SNMPv1/v2/v3:** SNMPv1/v2/v3 is activated.
- **Default:** SNMPv1/v2

### [SNMPv1/v2] - [Community]

Enter the community name to be monitored.

- **Available number of characters:** 0 - 32 characters
- **Default:** None (blank)

### **IMPORTANT**

- When using the SNMP function, it is necessary to enter the community name. When no community name is entered, the SNMP function will not work.

### [SNMPv3] - [User name]

Set the SNMPv3 user name.

- **Available number of characters:** Empty field or 1 - 32 characters
- **Unavailable characters:** " & ; \

### [SNMPv3] - [Authentication]

Select the SNMPv3 authentication method from MD5 or SHA1.

- **Default:** MD5

### [SNMPv3] - [Encryption method]

Select the SNMPv3 encryption method from DES or AES.

- **Default:** DES

**[SNMPv3] - [Password]**

Set the SNMPv3 password.

- **Available number of characters:**
  - If the authentication method is MD5: Empty field or 8-16 characters
  - If the authentication method is SHA1: Empty field or 8-20 characters
- **Unavailable characters:** " &

**[System name]**

Enter a system name to be used to manage the camera with the SNMP function.

- **Available number of characters:** 0 - 32 characters
- **Default:** None (blank)

**[Location]**

Enter the name of the location where the camera is installed.

- **Available number of characters:** 0 - 32 characters
- **Default:** None (blank)

**[Contact]**

Enter the E-mail address or the phone number of the SNMP manager.

- **Available number of characters:** 0 - 255 characters
- **Default:** None (blank)

## 2.9.2.8 Configure the QoS settings

The settings relating to the Diffserv function and shaping of stream are configured in this section.

### Diffserv

The Diffserv function can be used to set the priority of image/audio data sent from routers.

The priority set to this function must match the DSCP value configured to the router.

When using the Diffserv function, contact the network administrator.

Diffserv	
Image DSCP(0-63)	0
Audio DSCP(0-63)	0
Panasonic alarm protocol notification DSCP (0-63)	0
Shaping of stream	<input checked="" type="radio"/> On <input type="radio"/> Off

Set

**[Image DSCP(0-63)]**

Enter the packet priority for video data.

- **Available values:** 0 - 63
- **Default:** 0

### **[Audio DSCP(0-63)]**

Enter the packet priority for audio transmission/reception.

- **Available values:** 0 - 63
- **Default:** 0

### **[Panasonic alarm protocol notification DSCP(0-63)]**

Enter the packet priority for Panasonic alarm protocol notification.

- **Available values:** 0 - 63
- **Default:** 0

## **Shaping of stream**

### **[Shaping of stream]**

Select On/Off to determine whether or not to control the H.265 (or H.264) image data so that it does not burst. It is effective in situations such as when a network device loses video data from the camera, but the video display may be delayed.



### 2.9.3 How to configure HTTPS settings

The settings relating to the HTTPS protocol that can enhance the network security by encrypting the access to cameras on this page.

HTTPS settings can be configured by either using the certificate pre-installed to the camera, or using a CA certificate that you obtained by yourself from the CA (CA: Certification Authority). The settings will be configured in the following procedure.

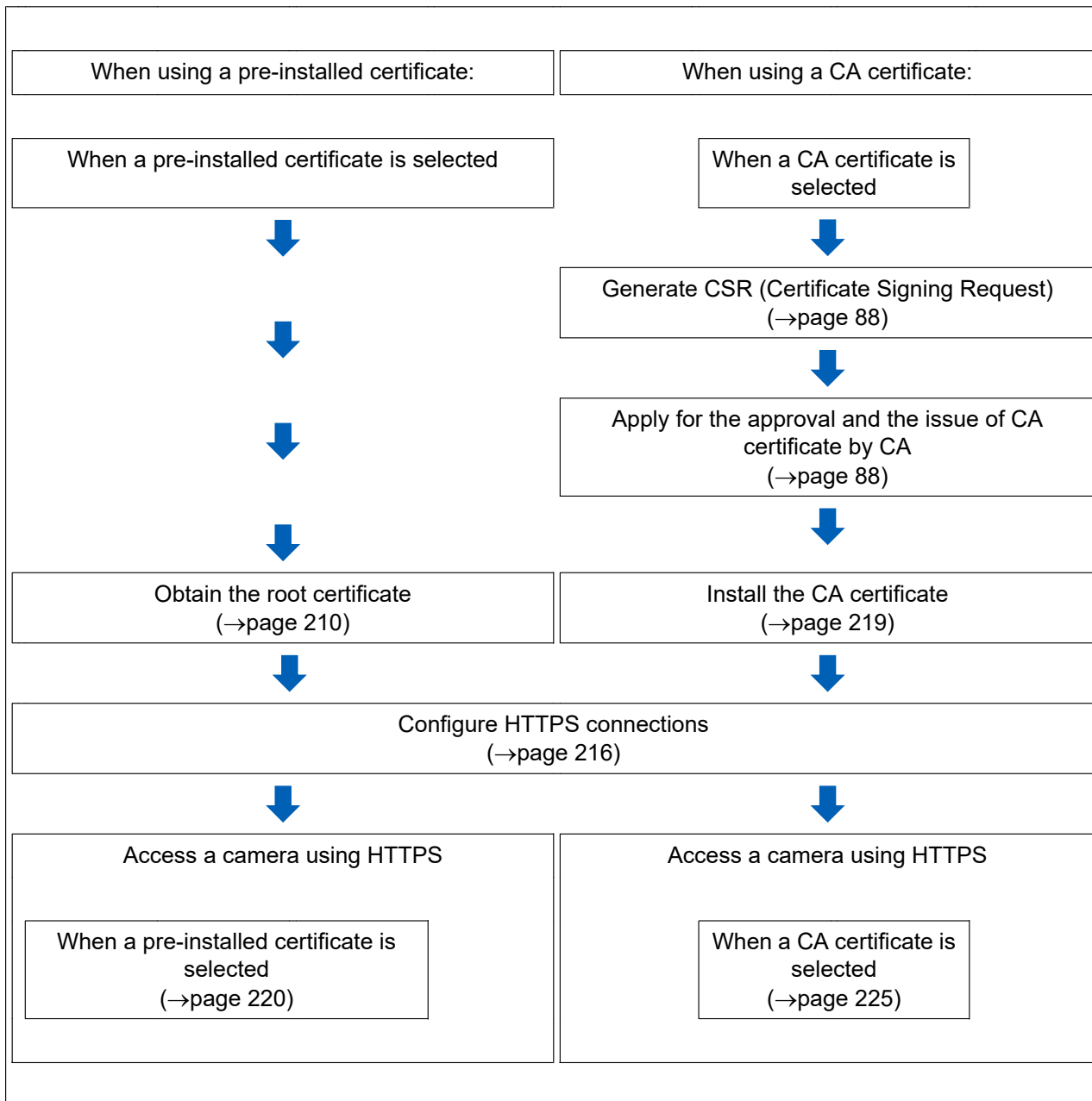

## 2 Settings

HTTPS	
Connection	HTTP <input type="button" value="v"/>
Select certificate	Pre-installed <input type="button" value="v"/>
HTTPS port	443 (1-65535)
Pre-installed certificate	
Download root certificate	<input type="button" value="Execute"/>
CA Certificate	
CRT key generate	<input type="button" value="Execute"/>
Generate Certificate Signing Request	<input type="button" value="Execute"/>
CA Certificate install	<input type="text" value=""/> <input type="button" value="Browse..."/> <input type="button" value="Execute"/>
Information	Invalid <input type="button" value="Confirm"/> <input type="button" value="Delete"/>

- ① Configuring the HTTPS connection (→page 216)
- ② Select the certificate (→page 210)
- ③ Obtain the root certificate (→page 210)
- ④ Generation of the CRT key (SSL encryption key) (→page 217)
- ⑤ Generation of CSR (Certificate Signing Request) (→page 218)
- ⑥ Install the CA certificate (→page 219)

### Note

- To use the CA certificate, you need to apply for the approval and the issue of CA certificate by CA.

### 2.9.3.1 Select the certificate to use when accessing with HTTPS

Select the certificate to be used with HTTPS with [HTTPS – Select certificate].

- **When using a pre-installed certificate:** Select “Pre-installed”.  
When “Pre-installed” is selected, a root certificate (page 210) must be obtained.
- **When using a CA certificate:** Select “CA”.

### Note

- “CA” can only be selected when a CA certificate has been added. Refer to page 209 for information on how to add a CA certificate.

### 2.9.3.2 Obtaining the root certificate

This procedure only needs to be done once for each PC that accesses the camera.

1. Access the camera, and click the [Execute] button for “Pre-installed certificate - Download root certificate” under “HTTPS” in the [Advanced] tab in the settings menu of the “Network” page. Click “Open” displayed on the bottom of the browser.

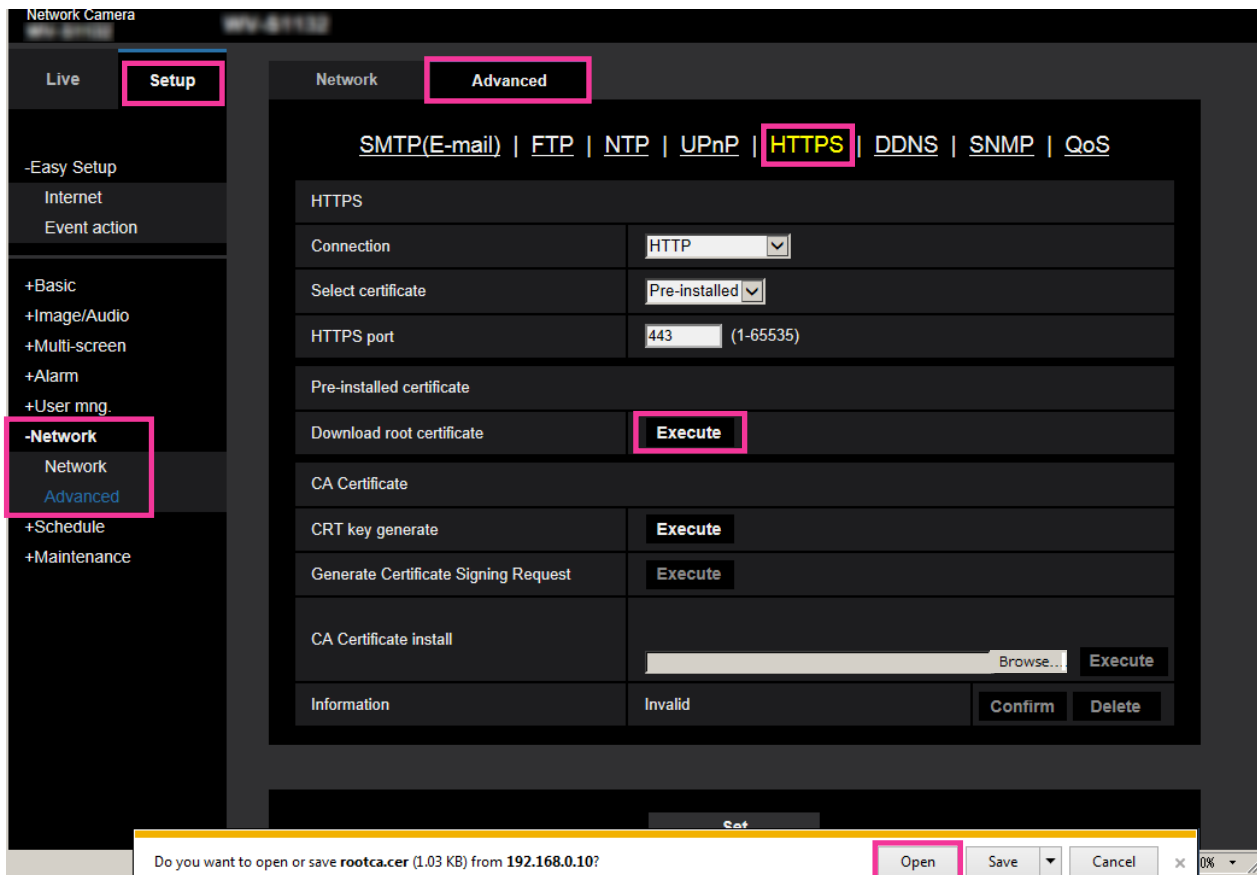

## 2 Settings

2. Click “Install Certificate...”.

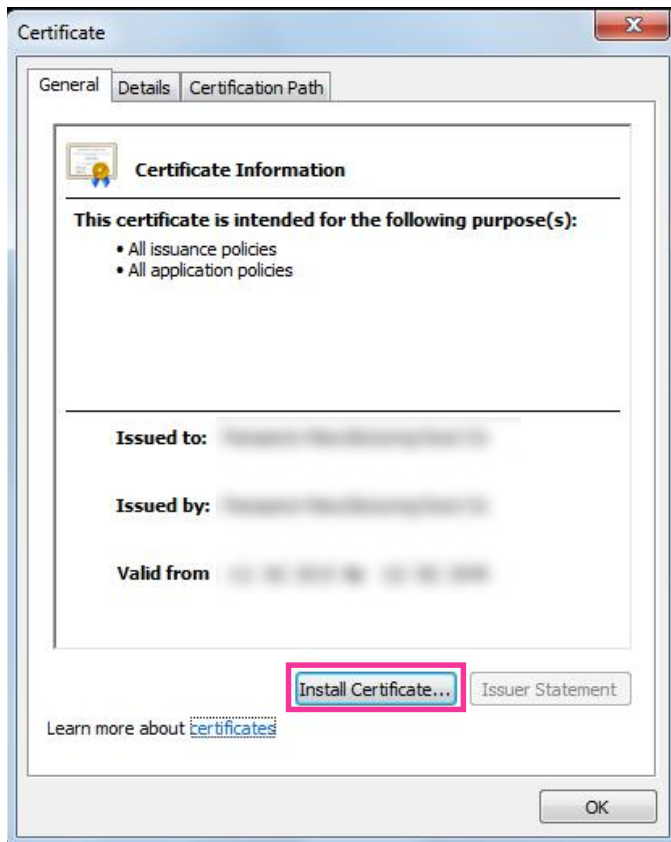

3. Click “Next” displayed in “Certificate Import Wizard”.



4. Select “Place all certificates in the following store”, and click “Browse...”.

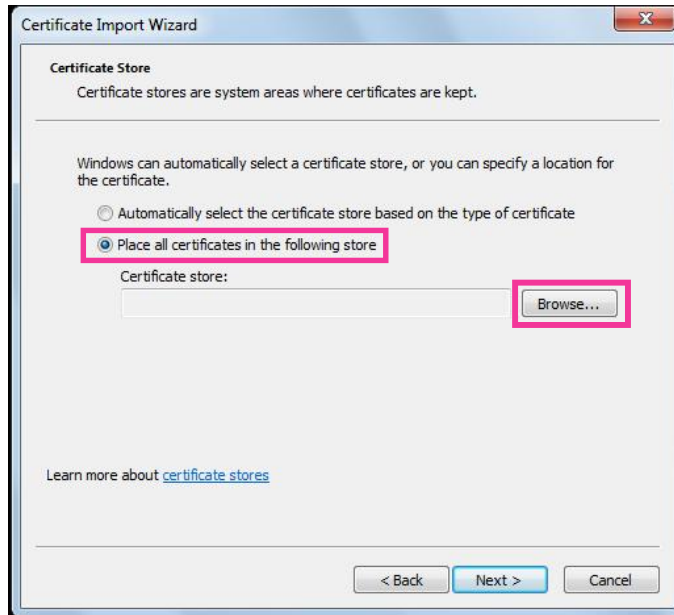

5. Select “Trusted Root Certificate Authorities”, and click “OK”.



6. Click “Next”.

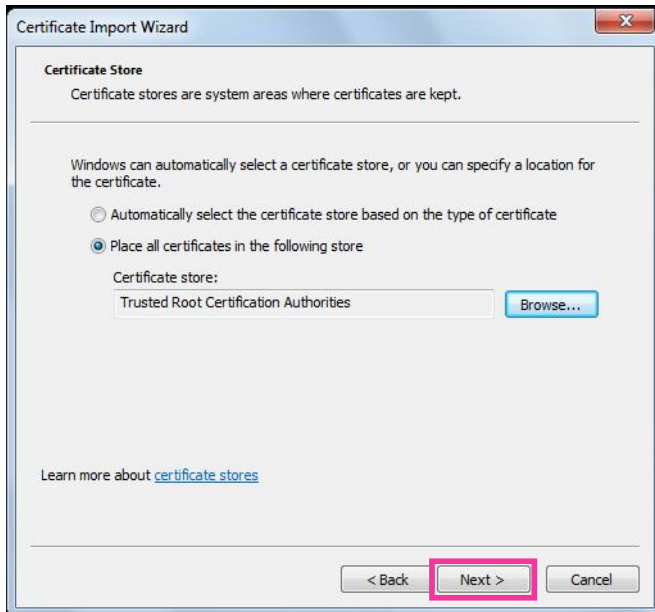

7. Click “Finish”.

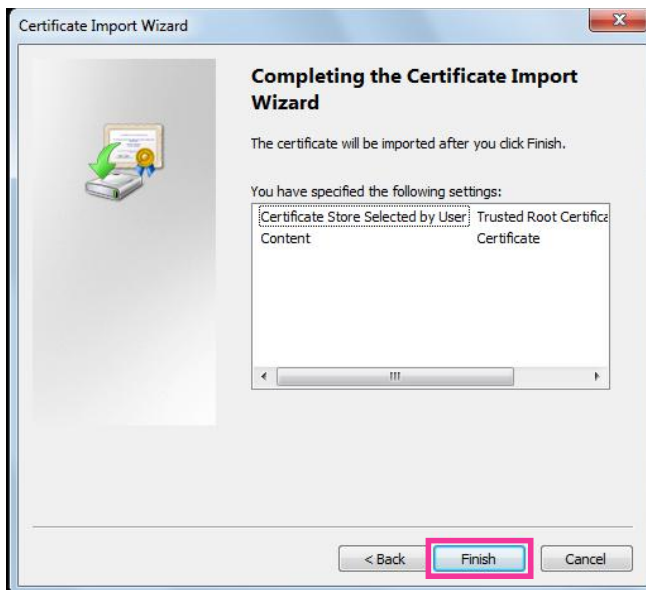

8. Confirm that the content shown next to “Thumbprint” in the “Security warning” window is as follows and then click “Yes”.
- Thumbprint (sha1): 0B886A3C E7F2DBA8 1035DDFA 2B21F80B 06778932

**Note**

- Other parties cannot create another thumbprint with the same values. You can confirm that you have retrieved the correct root certificate from the specified camera by confirming the values of the thumbprint.

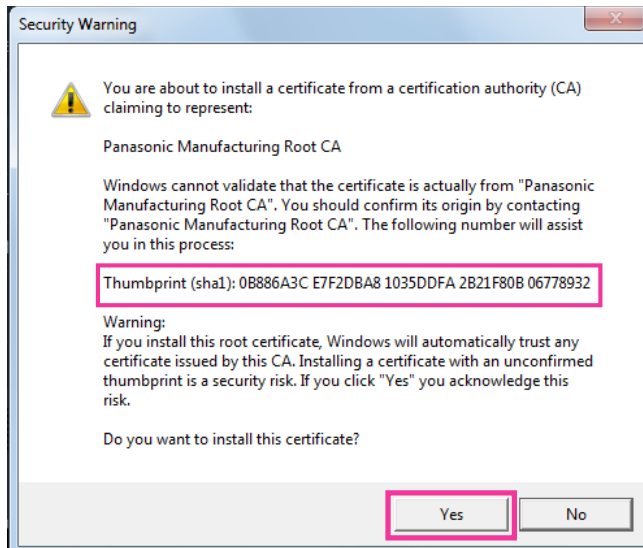

→ When the import is successfully completed, the screen "The import was successful." will be displayed.

9. Click the [OK] button.

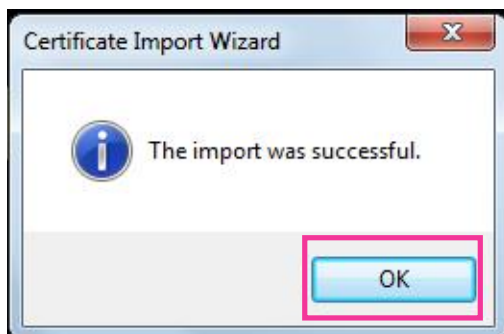

10. Click the [OK] button in the “Certificate” window to close the window.

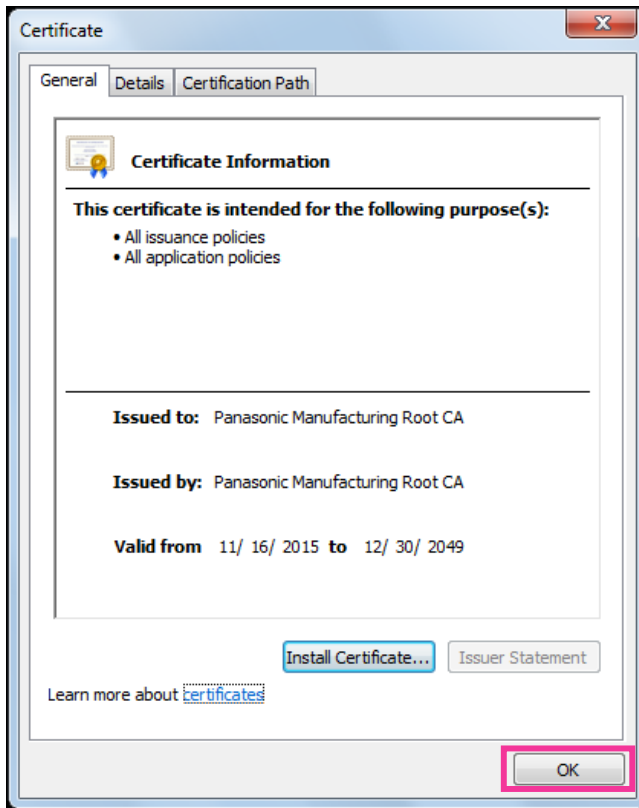

### 2.9.3.3 Configuration of HTTPS connections

1. Select “HTTPS” to access the camera in [HTTPS – Connection].
2. Designate the HTTPS port number to be used for [HTTPS – HTTPS port].
  - **Available port number:** 1 - 65535
  - **Default:** 443

The following port numbers are unavailable since they are already in use.  
20, 21, 23, 25, 42, 53, 67, 68, 69, 80, 110, 123, 161, 162, 554, 995, 10669, 10670, 59000 - 61000
3. Click the [Set] button.
  - It will become possible to access to the cameras using the HTTPS protocol.  
Restart the browser and access again.  
Refer to the following for information on methods to access cameras using HTTPS.
    - **Monitor images on a PC:** page 9
    - **Monitor images on a cellular phone:** page 21
    - **Monitor images on a mobile terminal:** page 23
4. If “Certificate error” is displayed, refer to the following.
  - **When using a pre-installed certificate:** page 210
  - **When using a CA certificate:** page 225

#### Note

- When the connection setting is changed, after waiting for a while, access the camera again with either “http://IP address of the camera” or “https://IP address of the camera” depending on the changed setting.



- **When using the pre-installed certificate:**  
In advance, install the root certificate of the Pre-installed certificate on the PC in use. Refer to page 210 for information on the setting procedure.
- When the camera is accessed using the HTTPS protocol, the refresh interval and frame rate of images may be lower.
- When the camera is accessed using the HTTPS protocol, it may take time to display images.
- When the camera is accessed using the HTTPS protocol, the images may be distorted or audio may be interrupted.
- The maximum number of concurrent access user varies depending on the maximum image size and transmission format.

### 2.9.3.4 Generation of the CRT key (SSL encryption key)

#### **IMPORTANT**

- When the CA certificate is valid, it is impossible to generate the CRT key.
  - When the CA certificate is used, the available key size varies depending on the CA. Confirm the available key size in advance.
  - To generate the CRT key, it may take about 2 minutes. Do not operate the web browser until the generation of CRT key is complete. While the CRT key is being generated, the refresh interval and line speed may be lower.
1. Click the [Execute] button of “CRT key generate”.  
→ The “CRT key generate” dialog box will be displayed.

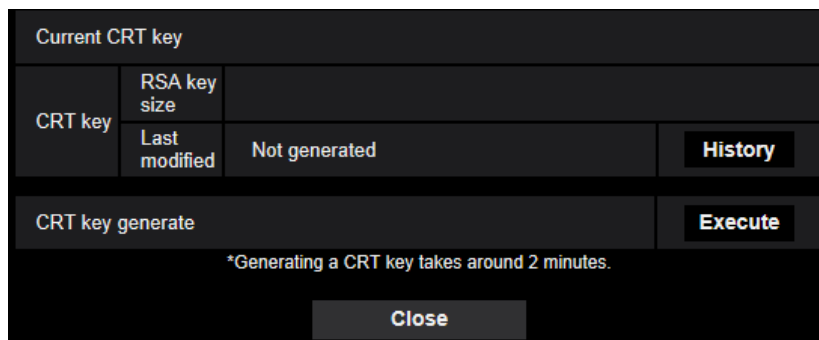

2. Click the [Execute] button.  
→ The generation of CRT key will be started. When the generation is finished, the key size and generation time & date of the generated key will be displayed on “Current CRT key”.

#### **Note**

- To change (or update) the generated CRT key, perform step 1 to 2. The CRT key and CA certificate are valid in a set. When the CRT key is changed, it is necessary to re-apply for the CA certificate.
- When the CRT key is updated, the log of the previous CRT key is saved. When the [History] button of “Current CRT key” on the “CRT key generate” dialog box is clicked, the “Previous CRT key” dialog box will be displayed, and it is possible to check the key size and generation time & date of the previous

key. When the [Apply] button is clicked on the “Previous CRT key” dialog box, it is possible to replace the current CRT key with the previous one.

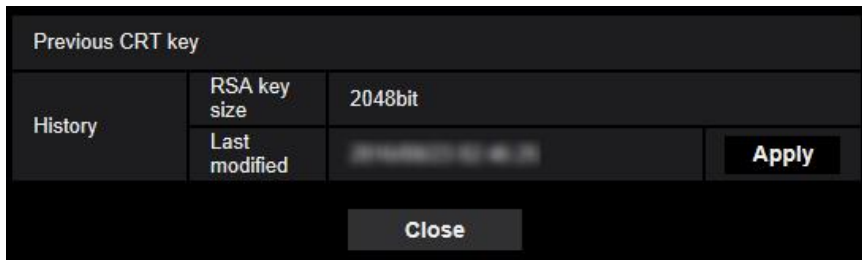

### 2.9.3.5 Generation of CSR (Certificate Signing Request)

**IMPORTANT**

- If the CRT key is not generated, it is impossible to generate the CSR.
  - Before generating the CSR file, configure the following settings on [Internet Options] of the web browser in advance. Click [Internet Options...] under [Tools] of the menu bar of Internet Explorer, and then click the [Security] tab.
    - Register the camera for [Trusted Sites].
    - Click the [Custom level...] button to open the [Security Settings] window, and check the [Enable] radio button of [File Download] under [Downloads].
    - Click the [Custom level...] button to open the [Security Settings] window, and check the [Enable] radio button of [Automatic prompting for file downloads] under [Downloads].
1. Click the [Execute] button of “CA Certificate - Generate Certificate Signing Request”.  
→ The “CA Certificate - Generate Certificate Signing Request” dialog box will be displayed.



2. Enter the information of the certificate to be generated.

Item	Description	Available number of characters
[Common Name]	Enter the camera address or host name.	64 characters
[Country]	Enter the country name.	2 characters (Country code)

Item	Description	Available number of characters
[State]	Enter the state name.	128 characters
[Locality]	Enter the locality name.	128 characters
[Organization]	Enter the organization name.	64 characters
[Organizational Unit]	Enter the unit name of the organization.	64 characters
[CRT key]	Displays the key size and generation time & date of the current key.	—

**Note**

- To use the CA certificate, follow the requests from the CA about the information to be entered.
  - The available characters for [Common Name], [State], [Locality], [Organization], [Organizational Unit] are 0-9, A-Z, a-z and the following marks.  
- . \_ , + / ( )
- Click the [OK] button after entering the items.  
→ The [Save As] dialog box will be displayed.
  - Enter a file name for the CSR in the [Save As] dialog box to save on the PC.  
→ The saved CSR file will be applied to the CA.

**IMPORTANT**

- The CA certificate will be issued for the set of the generated CSR and CRT key. If the CRT key is re-generated or updated after applying to the CA, the issued CA certificate will be invalidated.

**Note**

- This camera generates the CSR file in the PEM format.

### 2.9.3.6 Installation of the CA certificate

**IMPORTANT**

- If the CSR file is not generated, it is impossible to install the CA certificate.
  - For the installation of the CA certificate, the CA certificate issued by CA is required.
- Click the [Browse...] button of "CA Certificate - CA Certificate install".  
→ The [Open] dialog box will be displayed.
  - Select the CA certificate file and click the [Open] button. Then, click the [Execute] button.  
→ The CA certificate will be installed.

**Note**

- The host name registered in the installed CA certificate will be displayed on "CA Certificate - Information". Depending on the status of the CA certificate, the following are displayed.

Indication	Description
Invalid	The CA certificate is not installed.
[CA certificate Host name]	The CA certificate has already been installed and validated.

Indication	Description
Expired	The CA certificate has already expired.

- When the [Confirm] button is clicked, the registered information of the CA certificate will be displayed in the “CA Certificate - Confirm” dialog box. (Only “Organizational Unit” will be displayed with an asterisk (\*).)

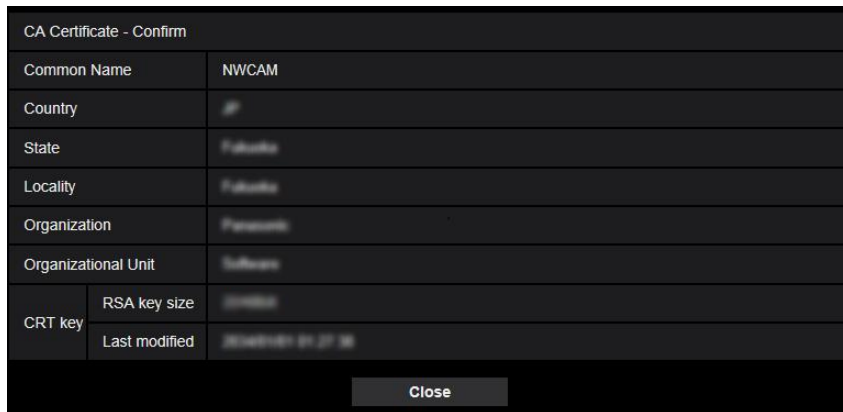

- When the [Delete] button is clicked, the installed CA certificate will be deleted.
- When “HTTPS” is selected for “Connection”, it is impossible to delete the CA certificate.
- To update the CA certificate, perform step 1 and 2.

**IMPORTANT**

- Before deleting the valid CA certificate, confirm that there is a backup file of the CA certificate on the PC or another media. The backup file of the CA certificate will be required when installing the CA certificate again.
- When the CA certificate has expired, the HTTPS function will become unavailable. When the camera is restarted, the connection protocol will be changed to HTTP. Update the CA certificate before it expires.
- The expiration date of the CA certificate can be checked by double-clicking the CA certificate file issued by CA.

## 2.9.4 Access the camera using the HTTPS protocol (for pre-installed certificate)

When accessing the camera with HTTPS from a browser using the pre-installed certificate, in order to stop a warning message from being played, you must configure your PC by following the steps below. Explanations are based on procedures for Windows 7 using Internet Explorer 11. Procedures for other operating systems or browsers may differ.

### 2.9.4.1 Configuration of the host file

This procedure must be done on each PC for all the camera that are accessed.

**Note**

- The following procedure cannot be used if you are using DDNS.

1. Start the browser and then access the camera using the HTTPS protocol.

- When the security alert window is displayed, click “Continue to this website (not recommended).”

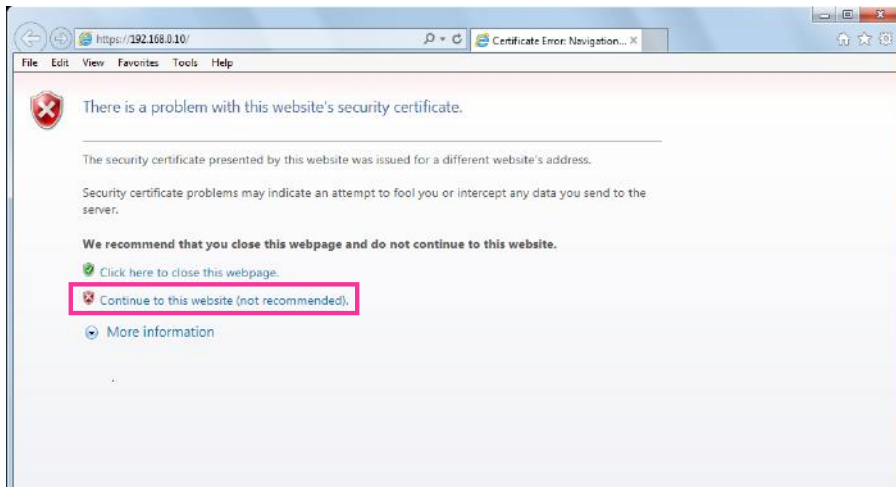

→The “Live” page will be displayed. If an authentication window is displayed, enter the user name and password.

#### Note

- This warning is displayed because the text entered in the address box does not match the text displayed in the subject of the certificate. This type of warning is displayed because when the certificate for the pre-installed certificate is created, the IP address or domain name assigned to the camera has not been determined yet. However, because the certificate configured in “2.9.3.2 Obtaining the root certificate” (→page 210) is only issued for Panasonic products, this is not a problem.
- Click “Certificate error” over the URL, and click “View certificates” on the bottom of the “Mismatched Address” window.

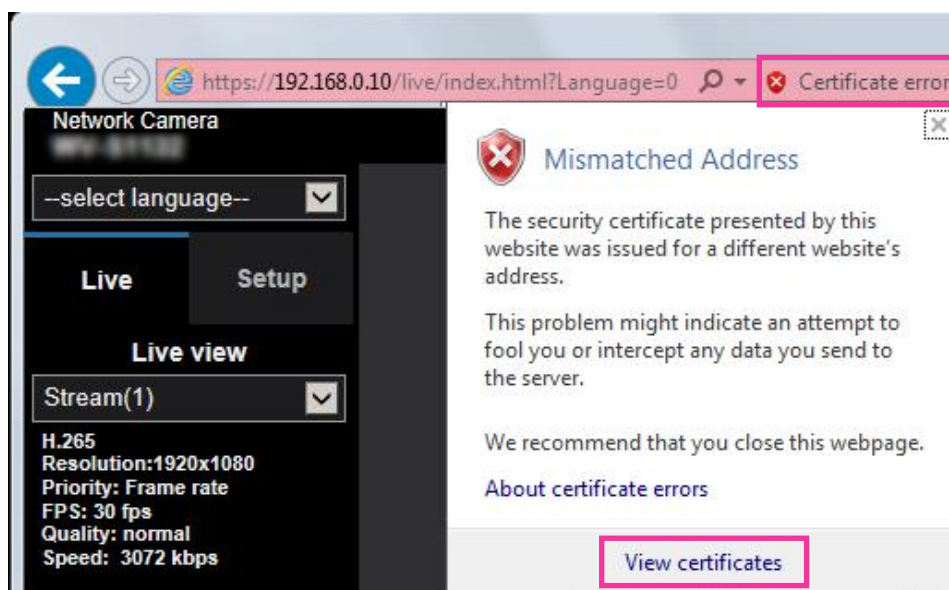

### Note

- If “Certificate Invalid” is displayed as shown below even though you have installed the root certificate (→page 210), end the connection, and check that no suspicious devices are connected.

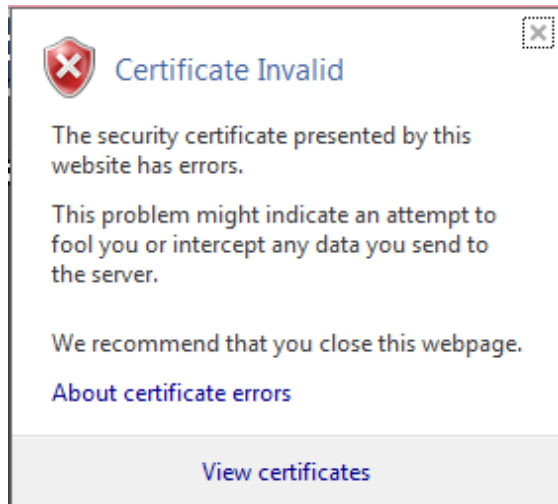

4. The “Certificate” window is displayed. Select the “Details” tab.

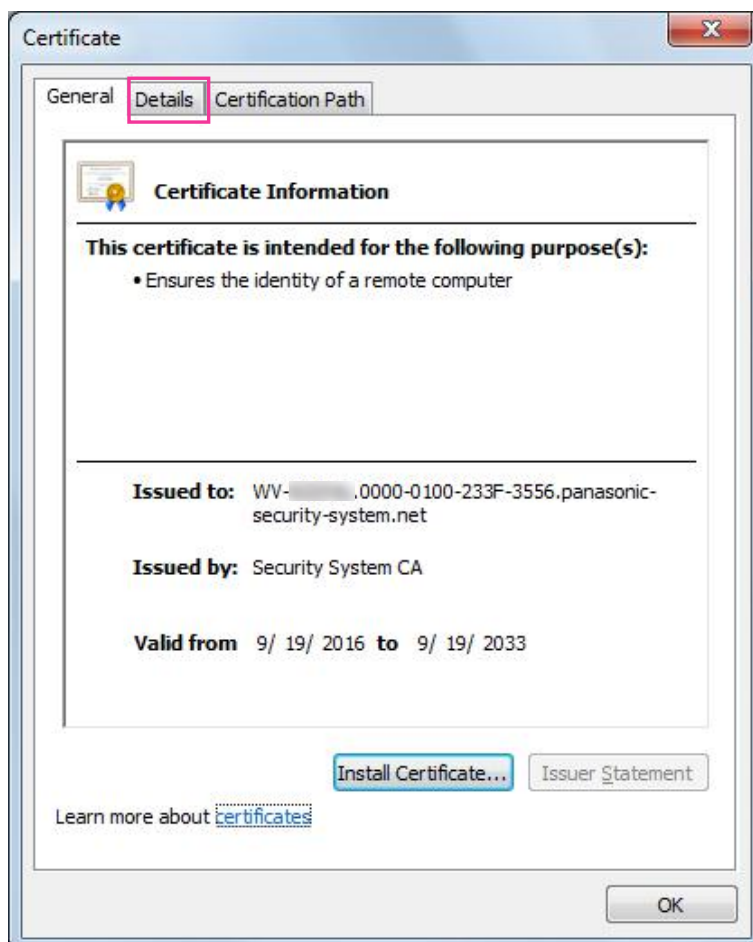

5. Confirm <All> that is displayed for “Show” and then click “Subject” in the field. Copy the text shown after “CN=” in the lower box.

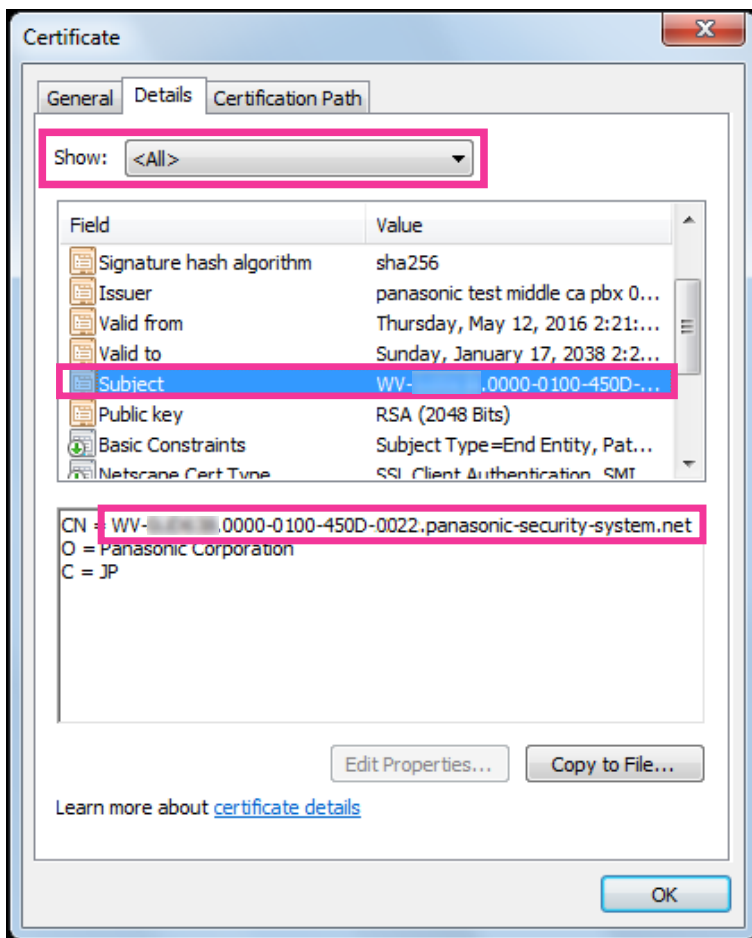

## 2 Settings

- From the Start menu enter the following text in the “Search programs and files” text box and then press [Ctrl], [Shift], and [Enter] at the same time.  
notepad C:\Windows\System32\drivers\etc\hosts

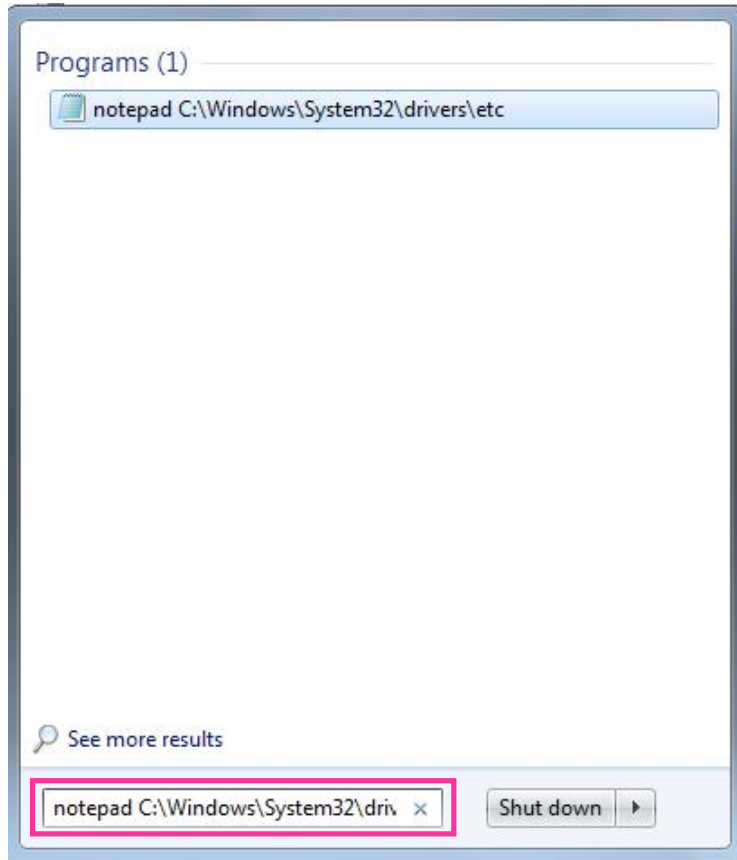

- If the “User Account Control” window is displayed, select “Yes”.
- The “hosts - Notepad” window is opened. Add the following text to the end of the file.  
(camera IP address) (copied text from step 5)  
The example is when the IP address is “192.168.0.10” and the CN of the camera is “WV-xxxxxx.0000-0100-450D-0022.panasonic-security-system.net”.

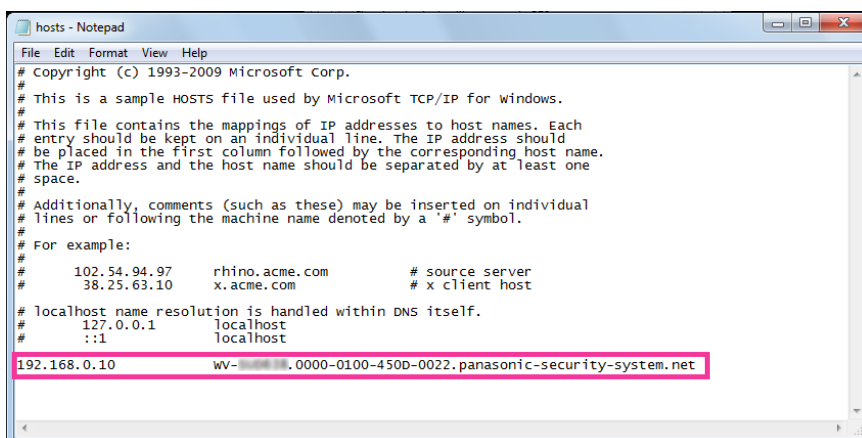

- Select “File” → “Save” to save the file and then close the file.



10. When accessing with a browser, add the following text for the CN after entering “https://” in the “address” box.

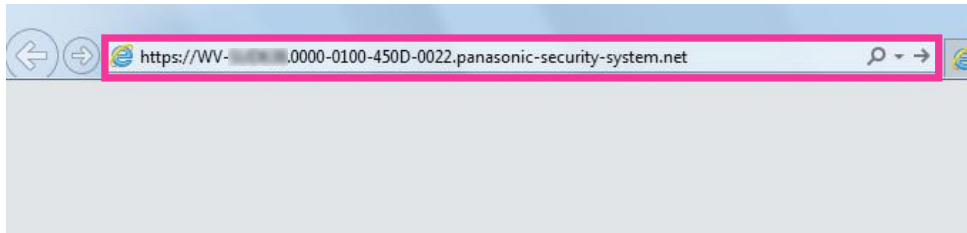

### IMPORTANT

- When the HTTPS port number is changed from “443”, enter “the following text for CN + : (colon) + port number” in the address box of the browser.  
Example of when the port number is “61443”:  
https://WV-xxxxxx.0000-0100-450D-0022.panasonic-security-system.net:61443
- We recommend adding the camera's URL to your browser's bookmark. If you forget the camera's URL, refer to the hosts file.

11. When the settings are completed, the color of the background of the address box changes to white. Confirm that “Website Identification” is displayed after clicking the key mark on the right side of the address bar.

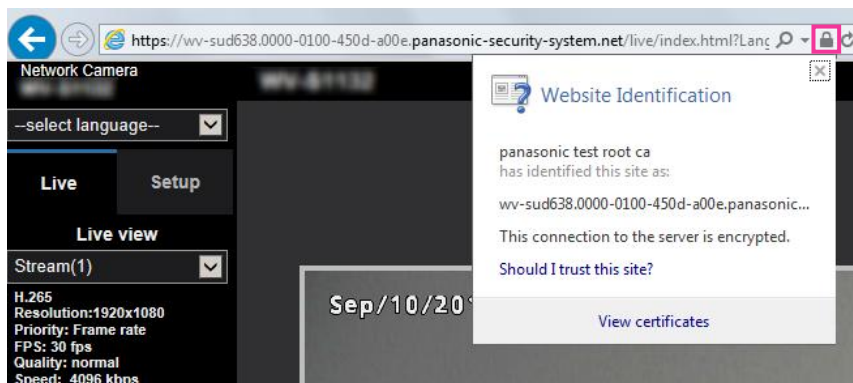

### Note

- If you cannot access with this method it may be because of proxy server settings. Ask the network administrator.

### IMPORTANT

- When the camera is accessed using the HTTPS protocol, the refresh interval and frame rate of images may be lower.

## 2.9.5 Access the camera using the HTTPS protocol (for CA Certification)

1. Start up the web browser.
2. Enter the IP address of the camera in the address box of the browser.
  - **Example of entry:** https://192.168.0.10/

### **IMPORTANT**

- When the HTTPS port number is changed from “443”, enter “https://IP address of the camera + : (colon) + port number” in the address box of the browser.  
(**Example:** https://192.168.0.11:61443)
  - When the camera is in a local network, configure the proxy server setting of the web browser (under [Internet Options...] under [Tools] of the menu bar) to bypass the proxy server for the local address.
3. Press the [Enter] key on the keyboard.  
→ The “Live” page will be displayed.

### **IMPORTANT**

- When the camera is accessed using the HTTPS protocol, the refresh interval and frame rate of images may be lower.

## 2.9.6 How to configure the settings relating to DDNS

When activating the DDNS function using the camera, either of the following DDNS services is available.

- “Viewnetcam.com” service
- Dynamic DNS Update (RFC2136 compliant)

### **IMPORTANT**

- Before using the DDNS service, it is necessary to perform the port forwarding setting for the router.
- **About Dynamic DNS Update (RFC2136 compliant)**  
Operation using DDNS services other than the “Viewnetcam.com” service is not guaranteed. We are not responsible for any troubles or accidents on the circumstances where the camera is used arising out of such services.  
Refer to the DDNS service providers for the selection and configuration of the DDNS services other than the “Viewnetcam.com” service.

### **Note**

- “Viewnetcam.com” is a Dynamic DNS service designed for use with Panasonic Network Cameras. Refer to the “Viewnetcam.com” website (<http://www.viewnetcam.com/>) for further information about the service.

## About DDNS services (IPv4/IPv6)

By using a DDNS service, it becomes possible to view camera images via the Internet.

The DDNS service associates dynamic global addresses and domain names.

It is possible to configure the settings for the “Viewnetcam.com” or Dynamic DNS Update (RFC2136 compliant). In most of the DNS services offered by providers, global addresses are not static but dynamic. Therefore, access to the camera via an old global address may be invalidated after a certain period of time. Either of the following services is required when accessing a camera whose global address is not static via the Internet.

- **DDNS service (such as “Viewnetcam.com”)**  
It is possible to access via a registered and static domain name (example: \*\*\*\*\*.viewnetcam.com) even after the global address is changed. Enrollment in a domain name service is required even when using the IPv6 connection.  
Refer to the “Viewnetcam.com” website (<http://www.viewnetcam.com/>) for further information about the service.
- **Static IP address service (such as a service offered by a contracted provider)**  
In this service, global addresses are static (not changed).

## 2.9.6.1 Configuration of the DDNS service (Example of the “Viewnetcam.com” service)

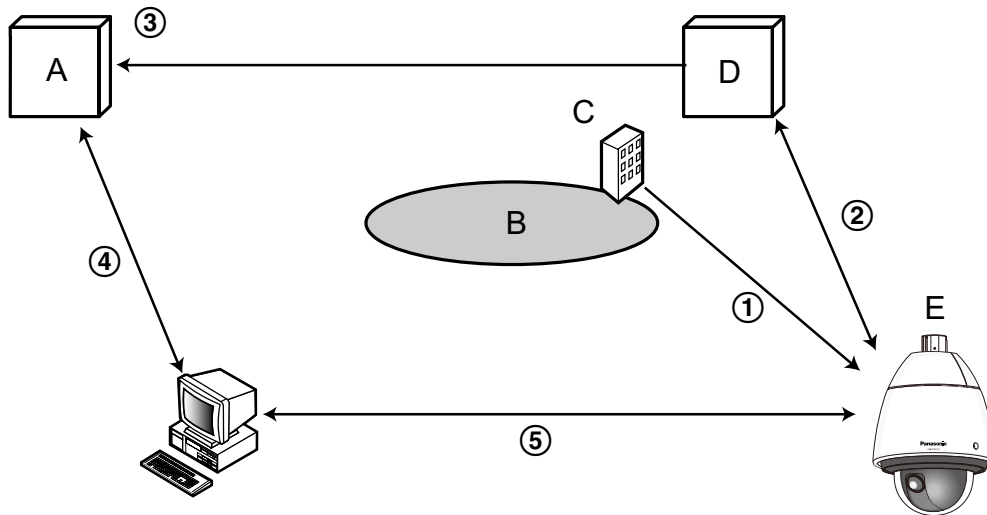

- A.** DNS server  
**B.** Internet  
**C.** Provider  
**D.** “Viewnetcam.com” service server  
**E.** Remote site

**① Global address is changed.**

The contracted provider allocates a global address to the router (or the camera). The global address is not static but dynamic.

**② “\*\*\*\*\*.viewnetcam.com” and the current global address is automatically registered.**

If you are enrolled in “Viewnetcam.com”, the unique “domain name” (example: \*\*\*\*\*.viewnetcam.com) will be allocated. The “Viewnetcam.com” service server automatically manages the domain name of camera and the global address of router (or camera) when a camera automatically notifies the service server of the global address.

**③ Current global address is automatically registered via “\*\*\*\*\*.viewnetcam.com”.**

The “Viewnetcam.com” service server registers the global address and the domain name of router (or camera) in the DNS server.

**④ Global address is obtained via the URL (domain name).**

By entering the URL (including the domain name) on the web browser when accessing the camera via the Internet, the DNS server identifies the registered global address of router (or camera).

**⑤ Access using the current global address**

The identified global address is used for accessing the router (or camera) to monitor images.

**Note**

- Refer to the contracted provider whether the current IP address is static or not.
- Depending on the provider, local addresses may be allocated. In this case, the DDNS service is unavailable. Refer to the contract provider for further information.

### When using the “Viewnetcam.com” service

DDNS	
Area	Global
Service	Viewnetcam.com
Personal(Camera) URL	
Your Account Link	
Access interval	1h
Global IP Address Notification Method	<input type="radio"/> Normal <input checked="" type="radio"/> Advanced

**Set**

#### [Personal(Camera) URL]

The URL of the camera registered for “Viewnetcam.com”.

#### [Your Account Link]

When the displayed URL is clicked, the registration window for the “Viewnetcam.com” service will be displayed in a newly opened window.

Register the information in the registration window to enroll in the “Viewnetcam.com” service.

#### [Access interval]

Select the interval to access the “Viewnetcam.com” service server to check the IP address and the host name from the following.

10min/ 20min/ 30min/ 40min/ 50min/ 1h

- **Default:** 1h

#### [Global IP Address Notification Method]

Typically [Global IP Address Notification Method] should be set to “Normal”.

If you cannot access the camera using the registered URL 30 minutes after registering with “Viewnetcam.com”, select “Advanced”.

In this case, UPnP (→page 201) must be enabled for the camera and for the router.

- **Default:** Normal

### Procedure to register information for the “Viewnetcam.com” service

1. Select [Viewnetcam.com] for [Service] and click the [Set] button.  
→ A URL is displayed in [Your Account Link].  
If a URL is not displayed in [Your Account Link], confirm the camera's network settings and Internet connection, then click [Set] again.
2. Register the information for “Viewnetcam.com” by following the instructions of the wizard.  
→ The registration window for “Viewnetcam.com” will be displayed in a newly opened window.

When the registration window is not displayed, check that the PC is being connected to the Internet, and click the reload button of the browser.

The screenshot shows the 'Advanced' settings page with the 'DDNS' section expanded. The 'Personal(Camera) URL' field is currently empty. The 'Global IP Address Notification Method' is set to 'Advanced'.

DDNS	
Area	Global
Service	Viewnetcam.com
Personal(Camera) URL	
Your Account Link	http://:*****
Access interval	1h
Global IP Address Notification Method	<input type="radio"/> Normal <input checked="" type="radio"/> Advanced

**Set**

3. Register the information for “Viewnetcam.com” by following the instructions of the wizard.
  - When the message “The new camera is successfully registered to Viewnetcam.com” is displayed, close the registration window.

The URL set at the time of registration can be used for camera access. However, this URL is unavailable when accessing the camera from the PC connected to the same network (LAN).

The screenshot shows the 'Advanced' settings page with the 'DDNS' section expanded. The 'Personal(Camera) URL' field now contains a generated URL: \*\*\*\*.\*\*\*\*.\*\*\*. The 'Global IP Address Notification Method' is set to 'Advanced'.

DDNS	
Area	Global
Service	Viewnetcam.com
Personal(Camera) URL	****.****.***
Your Account Link	http://:*****
Access interval	1h
Global IP Address Notification Method	<input type="radio"/> Normal <input checked="" type="radio"/> Advanced

**Set**

### Note

- When the registration for the “Viewnetcam.com” service is completed, the URL registered for “Personal(Camera) URL” is displayed. It may take up to about 30 minutes until the URL of the registered camera is validated.
- To cancel the enrollment in the “Viewnetcam.com” service, access the “Viewnetcam.com” website (<http://www.viewnetcam.com/>) later.
- When “Expired” is displayed in the URL of “Viewnetcam.com” in the viewnetcam settings page or the status page, restart the camera after registering the “Viewnetcam.com” service. After restarting the camera, check that the registered URL is displayed in the URL of “Viewnetcam.com” of [Status] - [Viewnetcam.com] on the “Maintenance” page.
- It is possible to check the information registered for the “Viewnetcam.com” service by accessing the URL displayed beside “Your Account Link”. When the URL is not displayed, check that the PC is being connected to the Internet, and click the [Set] button.

- If access often fails due to the change in the global address of router, set a smaller value for “Access interval”.

### Checking the information registered for the “Viewnetcam.com” service

It is possible to check if the camera has been registered for the “Viewnetcam.com” service. (→page 241)

#### 2.9.6.2 When using “Dynamic DNS Update”

The screenshot shows a web interface for configuring Dynamic DNS Update. At the top, there are tabs for 'Network' and 'Advanced', with 'Advanced' selected. Below the tabs, there are links for 'SMTP(E-mail)', 'FTP', 'NTP', 'UPnP', 'HTTPS', 'DDNS', 'SNMP', and 'QoS'. The 'DDNS' section is active, showing a table with the following fields: 'Area' (Global), 'Service' (Dynamic DNS Update), 'Host name' (empty text box), and 'Access interval' (24h). A 'Set' button is located at the bottom of the form.

DDNS	
Area	Global
Service	Dynamic DNS Update
Host name	
Access interval	24h

Set

##### [Host name]

Enter the host name to be used for the Dynamic DNS Update service.

- **Available number of characters:** 3 - 250 characters  
Enter in the form of “(host name). (domain name)”.
- **Available characters:** Alphanumeric characters, the colon (:), the period (.), the underscore (\_), and the hyphen (-).
- **Default:** None (blank)

##### **Note**

- Refer to the network administrator for further information about the available host names.

##### [Access interval]

Select the interval to access the Dynamic DNS Update service server to check the IP address and the host name from the following.

10min/ 20min/ 30min/ 40min/ 50min/ 1h/ 6h/ 24h

- **Default:** 24h

### 2.9.6.3 When using “Dynamic DNS Update(DHCP)”

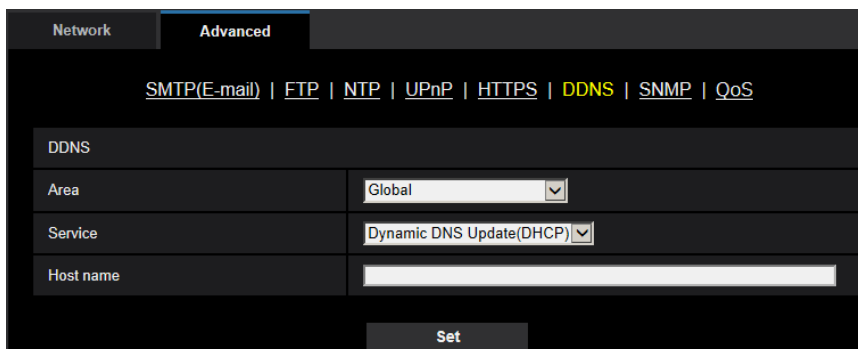

The screenshot shows a web-based configuration interface for Dynamic DNS Update (DHCP). At the top, there are tabs for 'Network' and 'Advanced', with 'Advanced' selected. Below the tabs, there is a navigation bar with links for SMTP(E-mail), FTP, NTP, UPnP, HTTPS, DDNS (highlighted in yellow), SNMP, and QoS. The main content area is titled 'DDNS' and contains a table with the following fields:

DDNS	
Area	Global
Service	Dynamic DNS Update(DHCP)
Host name	<input type="text"/>

At the bottom of the form is a 'Set' button.

#### [Host name]

Enter the host name to be used for the Dynamic DNS Update service.

- **Available number of characters:** 3 - 250 characters  
Enter in the form of “(host name). (domain name)”.
- **Available characters:** Alphanumeric characters, the colon (:), the period (.), the underscore (\_), and the hyphen (-).
- **Default:** None (blank)

#### **Note**

- Refer to the network administrator for further information about the available host names.

## 2.10 Configure the settings relating to the schedules [Schedule]

On the “Schedule” page, it is possible to configure the settings relating to schedules as follows.

- Alarm permission (Terminal alarm 1, 2, 3)
- Alarm permission(Terminal alarm 1)
- Alarm permission(Terminal alarm 2)
- Alarm permission(Terminal alarm 3)
- VMD permission
- Audio detection permission
- Access permission
- SD memory recording
- Scene file
- FTP periodic image transmission
- Allow e-mail transmission
- Position refresh
- Preset position (1-256)

The “Schedule” page has only the [Schedule] tab.



Up to 5 schedules can be set.

The screenshot displays the 'Schedule' configuration screen. It features five schedule entries, each with a color-coded icon and a 'Schedule mode' dropdown menu set to 'Off'. Below each mode is a 'Time range' section with checkboxes for days of the week (Mon-Sun) and a '24h' checkbox. A weekly calendar grid is shown below, with time slots from 0:00 to 24:00. A 'Set' button is located at the bottom of the screen.

1. Select an action to be assigned to the schedule from "Schedule mode".  
 "Off" is selected at the default.
  - **Off:** No action will be taken for the respective schedule.
  - **Alarm permission (Terminal alarm 1, 2, 3):** Alarm input (terminal alarm) will be allowed during the period of the schedule.
  - **Alarm permission(Terminal alarm 1):** Terminal 1 alarm input will be allowed during the period of the schedule.
  - **Alarm permission(Terminal alarm 2):** Terminal 2 alarm input will be allowed during the period of the schedule.

- **Alarm permission(Terminal alarm 3):** Terminal 3 alarm input will be allowed during the period of the schedule.
- **VMD permission:** The video motion detection (VMD) function will be active during the period of the schedule.
- **Audio detection permission:** The audio detection function will be active during the period of the schedule.
- **Access permission:** Users whose access level is set to “2. Camera control” and “3. Live only” on the [User auth.] tab (→page 177) can access the camera only in the period of schedule.
- **Recording to SD(Recording stream1):** The SD recording will be performed at the designated time in the schedule. Further, the “Recording format” is enabled only when there is a stream.
- **Recording to SD(Recording stream2):** The SD recording will be performed at the designated time in the schedule. Further, the “Recording format” is enabled only when there is a stream.
- **Position refresh:** The camera position will be refreshed at the designated time in the schedule.
- **1-256:** The camera will move to the selected position from the preset position at the designated time in the schedule.
- **Image adjust 1: Scene 1:** Images are set to the image settings of “Scene file 1” at the designated time in the schedule. When the designated time for the schedule finishes, images are set to the image settings of “Scene file is not applied”.
- **Image adjust 1: Scene 2:** Images are set to the image settings of “Scene file 2” at the designated time in the schedule. When the designated time for the schedule finishes, images are set to the image settings of “Scene file is not applied”.
- **Image adjust 1: Scene 3:** Images are set to the image quality settings of “Scene file 3” at the designated time in the schedule. Once designated time in the schedule is over, the image quality setting is set to “Scene file is not applied”.
- **Image adjust 1: Scene 4:** Images are set to the image quality settings of “Scene file 4” at the designated time in the schedule. Once designated time in the schedule is over, the image quality setting is set to “Scene file is not applied”.
- **FTP periodic image transmission:** FTP periodic image transmission will be performed at the designated time in the schedule.
- **E-mail permission:** While the schedule is set, e-mail notification is sent when alarm is input.

### **Note**

- Select “On” for “User auth.” on the [User auth.] tab of “User mng.” page (→page 177) and “Off” for “Host auth.” on the “Host auth.” page (→page 180) to validate “Access permission”.
  - When selecting “Recording to SD(Recording stream1)” or “Recording to SD(Recording stream2)”, select “Stream(1)”, “Stream(2)”, “Stream(3)”, or “Stream(4)” for “Recording format” on the [SD memory card] tab and select “Schedule” for “Save trigger”. (→page 81)
2. Select days of a week by checking the respective checkboxes.
  3. From the pull-down menu, select the start time and the end time of the schedule.  
When not designating time, check the checkbox of “24h”.
  4. Click the [Set] button after completing the settings.  
→ The result will be displayed at the bottom of the window.

### **Note**

- The schedules displayed at the bottom of the window can be identified by colors assigned to each schedule.
- If the schedules for position refresh and image quality are set to the same times, the action for image quality will be performed after the action for position refresh is finished.

## 2.10.1 How to set the schedules

The screenshot displays the 'Schedule' configuration page. It features five schedule entries, each with a color-coded label and a corresponding color swatch:

- Schedule 1 (White):** Schedule mode: Off. Time range: Mon, Tue, Wed, Thu, Fri, Sat, Sun. 24h checkbox is checked.
- Schedule 2 (Blue):** Schedule mode: Off. Time range: Mon, Tue, Wed, Thu, Fri, Sat, Sun. 24h checkbox is checked.
- Schedule 3 (Green):** Schedule mode: Off. Time range: Mon, Tue, Wed, Thu, Fri, Sat, Sun. 24h checkbox is checked.
- Schedule 4 (Red):** Schedule mode: Off. Time range: Mon, Tue, Wed, Thu, Fri, Sat, Sun. 24h checkbox is checked.
- Schedule 5 (Black):** Schedule mode: Off. Time range: Mon, Tue, Wed, Thu, Fri, Sat, Sun. 24h checkbox is checked.

Below the entries is a 24-hour grid for each day of the week (Mon-Sun). The grid has time markers at 0:00, 6:00, 12:00, 18:00, and 24:00. A 'Set' button is located at the bottom center of the interface.

1. Check the check box of the desired day of the week of “FTP image transmission schedule”.  
→ The selected day of the week will be validated for the schedule.
2. To designate time, select the desired “hour” and “minute” from the pull-down menu.  
When not designating time, check the checkbox of “24h”.

## 2 Settings

3. Click the [Set] button after completing the settings.  
→ The result will be displayed at the bottom of the window.

The screenshot displays the 'Schedule' configuration window. It features a table for configuring five schedules and a Gantt chart below it.

Schedule	Schedule mode	Time range
Schedule 1 (White)	VMD permission	<input checked="" type="checkbox"/> Mon <input checked="" type="checkbox"/> Tue <input checked="" type="checkbox"/> Wed <input checked="" type="checkbox"/> Thu <input checked="" type="checkbox"/> Fri <input checked="" type="checkbox"/> Sat <input checked="" type="checkbox"/> Sun 24h 09:00 - 17:30
Schedule 2 (Blue)	VMD permission	<input checked="" type="checkbox"/> Mon <input checked="" type="checkbox"/> Tue <input checked="" type="checkbox"/> Wed <input checked="" type="checkbox"/> Thu <input checked="" type="checkbox"/> Fri <input checked="" type="checkbox"/> Sat <input checked="" type="checkbox"/> Sun 24h 23:00 - 07:00
Schedule 3 (Green)	FTP periodic image transmission	<input type="checkbox"/> Mon <input type="checkbox"/> Tue <input type="checkbox"/> Wed <input type="checkbox"/> Thu <input type="checkbox"/> Fri <input checked="" type="checkbox"/> Sat <input checked="" type="checkbox"/> Sun <input checked="" type="checkbox"/> 24h
Schedule 4 (Red)	Off	<input type="checkbox"/> Mon <input type="checkbox"/> Tue <input type="checkbox"/> Wed <input type="checkbox"/> Thu <input type="checkbox"/> Fri <input type="checkbox"/> Sat <input type="checkbox"/> Sun 24h
Schedule 5 (Black)	Off	<input type="checkbox"/> Mon <input type="checkbox"/> Tue <input type="checkbox"/> Wed <input type="checkbox"/> Thu <input type="checkbox"/> Fri <input type="checkbox"/> Sat <input type="checkbox"/> Sun 24h

The Gantt chart below the table shows the time ranges for each schedule across the days of the week (0:00 to 24:00). Schedule 1 (White) is active from 09:00 to 17:30 on all days. Schedule 2 (Blue) is active from 23:00 to 07:00 on all days. Schedule 3 (Green) is active 24 hours on Saturday and Sunday. Schedules 4 (Red) and 5 (Black) are inactive (Off) on all days.

At the bottom of the window, there is a 'Set' button.

## 2.10.2 How to delete the set schedule

Schedule

Schedules

Schedule 1 (White) <span style="color: #fff;">■</span>	Schedule mode VMD permission
Time range	<input checked="" type="checkbox"/> Mon <input checked="" type="checkbox"/> Tue <input checked="" type="checkbox"/> Wed <input checked="" type="checkbox"/> Thu <input checked="" type="checkbox"/> Fri <input checked="" type="checkbox"/> Sat <input checked="" type="checkbox"/> Sun 24h 09:00 - 17:30
Schedule 2 (Blue) <span style="color: #007bff;">■</span>	Schedule mode VMD permission
Time range	<input checked="" type="checkbox"/> Mon <input checked="" type="checkbox"/> Tue <input type="checkbox"/> Wed <input checked="" type="checkbox"/> Thu <input checked="" type="checkbox"/> Fri <input checked="" type="checkbox"/> Sat <input checked="" type="checkbox"/> Sun 24h 23:00 - 07:00
Schedule 3 (Green) <span style="color: #28a745;">■</span>	Schedule mode FTP periodic image transmission
Time range	<input type="checkbox"/> Mon <input type="checkbox"/> Tue <input type="checkbox"/> Wed <input type="checkbox"/> Thu <input type="checkbox"/> Fri <input checked="" type="checkbox"/> Sat <input checked="" type="checkbox"/> Sun 24h : - :
Schedule 4 (Red) <span style="color: #dc3545;">■</span>	Schedule mode Off
Time range	<input type="checkbox"/> Mon <input type="checkbox"/> Tue <input type="checkbox"/> Wed <input type="checkbox"/> Thu <input type="checkbox"/> Fri <input type="checkbox"/> Sat <input type="checkbox"/> Sun 24h : - :
Schedule 5 (Black) <span style="color: #333;">■</span>	Schedule mode Off
Time range	<input type="checkbox"/> Mon <input type="checkbox"/> Tue <input type="checkbox"/> Wed <input type="checkbox"/> Thu <input type="checkbox"/> Fri <input type="checkbox"/> Sat <input type="checkbox"/> Sun 24h : - :

	0:00	6:00	12:00	18:00	24:00
Mon					
Tue					
Wed					
Thu					
Fri					
Sat					
Sun					

Set

1. Uncheck the check box of the set day of the week.

## 2 Settings

2. Click the [Set] button after completing the settings.  
→ The schedule of the selected day of the week is deleted.

The screenshot displays the 'Schedule' configuration screen. At the top, the title 'Schedule' is visible. Below it, the 'Schedules' section contains five entries, each with a color-coded label and a corresponding color swatch: Schedule 1 (White), Schedule 2 (Blue), Schedule 3 (Green), Schedule 4 (Red), and Schedule 5 (Black). Each entry has two rows of settings: 'Schedule mode' (a dropdown menu currently set to 'Off') and 'Time range' (checkboxes for days of the week and a '24h' option with time selection dropdowns). Below the settings is a grid representing the days of the week (Mon to Sun) and time intervals (0:00, 6:00, 12:00, 18:00, 24:00). The grid cells are shaded in alternating light and dark gray. At the bottom center, there is a 'Set' button.

## 2.11 Maintenance of the camera [Maintenance]

System log check, firmware upgrade, status check and initialization of the setup menu can be performed on this page.

The “Maintenance” page has the [System log] tab, the [Upgrade] tab, [Status] tab, the [Default reset] tab, and the [Data] tab.

### 2.11.1 Check the system log [System log]

Click the [System log] tab of the “Maintenance” page. (→For menu display and how to operate, refer to page 47, page 48)

Up to 4,000 system logs can be saved on the SD memory card when the SD memory card is inserted after selecting “Use” for “SD memory card” on the [SD memory card] tab (→page 78)

When “Not use” is selected for “SD memory card”, up to 100 system logs can be saved on the built-in memory of the camera.

When the saved system logs have reached the maximum number, the newer logs will overwrite the older system logs. In this case, the oldest log is the first to be overwritten.

The system logs will be displayed in group of 100 logs each, and the logs will be saved even when the power of the camera is turned off.

System log	Upgrade	Status	Default reset	Data
<< Previous 100		Next 100 >>		
No.	Time & date	Description		

#### [Next 100 >>]

When clicking “Next 100 >>”, the next 100 system logs will be displayed.

#### [<< Previous 100]

When clicking “<< Previous 100”, the previous 100 system logs will be displayed.

#### [No.]

The serial number of the system log will be displayed.

#### [Time & date]

Time and date at the error occurrence will be displayed.

#### Note

- When “Off” is selected for “Time display format” on the [Basic] tab (→page 71), time & date of logs will be displayed in 24-hour format.

#### [Description]

The descriptions about the system log will be displayed. Refer to page 254 for further information about the system logs.

### 2.11.2 Upgrade the firmware [Upgrade]

Click the [Upgrade] tab of the “Maintenance” page. (→page 47, page 48)

## 2 Settings

The current firmware can be checked and upgraded to the latest version on this page. Contact the dealer for further information about the firmware upgrade.

System log	Upgrade	Status	Default reset	Data
Model no.		[Model no.]		
MAC address		[MAC address]		
Serial no.		[Serial no.]		
Firmware version		[Firmware version]		
IP address(IPv6)	Linklocal			
	Static			
	RA			
	DHCPv6			
Viewer software installation counter		[Viewer software installation counter]		
Time past from the date of manufacture		[Time past from the date of manufacture]		
<a href="#">Ext. software &gt;&gt;</a>				
<div style="border: 1px solid black; padding: 10px;"><p style="text-align: right;"><a href="#">Browse...</a></p><p><input checked="" type="radio"/> Reset the settings to the default after completing the upgrade. (Except the network settings) <span style="float: right;"><b>Execute</b></span></p><p><input type="radio"/> Do not reset the settings to the default after the upgrade.</p><p>Resets to default HTML data after completing the upgrade.</p><p>Download the latest firmware from the following our website. Note: Internet connection required to view this page. - In case of using outside of Japan. <a href="http://security.panasonic.com/support/">http://security.panasonic.com/support/</a> - In case of using in Japan. <a href="http://sol.panasonic.biz/security/support/index.html">http://sol.panasonic.biz/security/support/index.html</a></p><p>It will take [ ] to complete the upgrade. Please wait and do not operate the browser during this process.</p></div>				

**[Model no.], [MAC address], [Serial no.], [Firmware version], [IP address(IPv6)], [Viewer software installation counter], [Time past from the date of manufacture]**

Information of each item will be displayed.

### **[Ext. software >>]**

A link for the extension software screen is displayed.

Refer to our website (<https://security.panasonic.com/kms/>) for further information about extension software.

1. Contact the dealer and download the latest firmware onto a PC.

### **IMPORTANT**

- A blank (space) cannot be used for the name of the directory where the downloaded firmware to be saved.



- Click the [Browse...] button and designate the downloaded firmware.

**Note**

- The latest firmware upgrade is posted on our website. The firmware is in a zip file. After downloading the file, unzip it and use the file with the “.img” extension to upgrade the firmware.
    - When using the camera in Japan  
<https://sol.panasonic.biz/security/support/index.html>
    - When using the camera outside of Japan  
<https://security.panasonic.com/support/>
  - To view the website, it is necessary to be connected to the internet.
- Click the radio button respective to the desired option to determine whether or not to initialize the settings after completing the firmware upgrade.  
**Default:** Do not reset the settings to the default after the upgrade.

**Note**

- Note that the settings cannot be restored after an initialization is operated.
- Click the [Execute] button.  
 → The confirmation window will be displayed.

**IMPORTANT**

- After upgrading, make sure to check the version on this page.
- After completing the upgrade, delete temporary internet files. (→page 259)
- Upgrade the firmware using a PC in the same subnet as the unit.
- Follow the instructions from the dealer when upgrading the firmware.
- When upgrading the application software, use the designated file (extension: img) for the firmware upgrade.  
 The name of the firmware to be used for the upgrade should be “model name (Use small letters. “WV-” is not required.)\_xxxxx.img”.  
 \* (“xxxxx” indicates the version of the firmware.)
- Do not turn off the power of the camera during the upgrade process.
- Do not perform any operation during upgrading and wait until it completes.
- The following network settings will not be reset when upgrading the firmware after selecting “Reset the settings to the default after completing the upgrade. (Except the network settings)”.  
 Primary server address and secondary server address DNS settings for IPv4, primary DNS server address and secondary DNS server address settings for IPv6, On/Off for DHCP, IP address, subnet mask, default gateway, HTTP port, HTTPS port, connection protocol (HTTP/HTTPS), CRT key, CA certificate, UPnP setting, line speed, bandwidth control (bit rate), time & date, preset position.
- The viewer software used on each PC should be licensed individually. Refer to your dealer for the software licensing.

### 2.11.3 Check the status [Status]

Click the [Status] tab of the “Maintenance” page. (→For menu display and how to operate, refer to page 47, page 48)

## 2 Settings

The status of this camera can be checked on this page.

System log	Upgrade	Status	Default reset	Data
UPnP				
Port number(HTTP)	-			
Status	Disable			
Port number(HTTPS)	-			
Status	Disable			
Router global address				
Self check				
Hardware1	0000 0000 0000 0000 0000 0000 0000 00			
Hardware2	0000 0000 0000 0000 0000 0000 0000 00			
Self check hardware status. There are no problems if number contains all 0's.				
Hardware information				
Status	Power On / Standby / Sleep / Motion / Alarm / (None)			
SD memory card				
Model no.	Not use			
Serial no.	Unknown			
Remaining capacity	----- 4GB ----- 4GB(remaining capacity/original capacity)			
Total use time	Unknown			
Number of overwrite times	Unknown			
No.	Time & date	Description		

## Viewnetcam.com

### [Server]

The URL of the "Viewnetcam.com" service server will be displayed.

### [Status]

The registration status for the "Viewnetcam.com" will be displayed.

### [Personal(Camera) URL]

The URL of the camera registered for "Viewnetcam.com" will be displayed.

## UPnP

### [Port number(HTTP), Port number(HTTPS)]

The port number that is set for UPnP port forwarding will be displayed.

### [Status]

The port forwarding status will be displayed.

**[Router global address]**

The global address of router will be displayed.

## Self check

The self check result of the hardware will be displayed. If all the items are "0", it indicates that the hardware is working normally.

## Hardware information

Information about PAN, TILT, ZOOM, FOCUS, Day Night(IR), reboot counter, operating time, and thermo-sensor, etc. will be displayed.

**Note**

- Refer to our website (<https://security.panasonic.com/support/info/>) for further information about the contents of the displayed statuses (relating to the "Viewnetcam.com" service, the UPnP function, or the self check).

## SD memory card

**[Model no.]**

This model does not support the model number display function.

**[Serial no.]**

This model does not support the serial number display function.

**[Remaining capacity]**

Displays the remaining capacity and total capacity of the SD memory card.

This is the same information that is displayed in [Remaining capacity] of the SD memory card information on the [SD memory card] tab of the "Basic" page.

**[Total use time]**

Displays the length of time that SD memory card has been inserted into and used with the camera.

If the length of time that the SD memory card has been used for cannot be obtained, "Unknown" is displayed. "Total use time" is updated once per hour.

**[Number of overwrite times]**

Displays the number of overwrite times as calculated from the total capacity of the SD memory card, the number of times the camera has written files to the SD memory card, and the file sizes.

If the number of overwrite times cannot be calculated, "Unknown" is displayed.

**Note**

- Because the overwrite time values are just estimates calculated by the camera, they may differ to the actual number of overwrite times.

## [No.] / [Time & date] / [Description] of the log

Displays the log related to the SD memory card.

Category	Indication	Description
SD memory card	<SD> Format	Successfully formatted the SD memory card.
	<SD> Format error	Error occurred when formatting the SD memory card.
	<SD> Write-protect ON (Locked card)	A write-protected SD memory card is inserted.
	<SD> Detection error	The SD memory card could not be correctly recognized.
	<SD> Write error	An error occurred when writing to the SD memory card.
	<SD> Read error	An error occurred when reading from the SD memory card.
	<SD> Delete error	An error occurred when deleting data from the SD memory card.
	<SD> File system error	An error occurred in File system of the SD memory card.
	<SD> Undefined error	An error other than the ones above has occurred for the SD memory card.

**IMPORTANT**

- In order to be able to correctly use this function, format the SD memory card with the camera before using it.
- When using SD memory cards that have been used on other devices such as PCs, the correct information may not be able to be displayed.
- Up to 30 SD memory card logs can be saved to the built-in memory of the camera. When the saved system logs have reached the maximum number, the newer logs will overwrite the older system logs.

**Note**

- Refer to our website (<https://security.panasonic.com/support/info/>) for further information about the contents of the displayed statuses (relating to the “Viewnetcam.com” service, the UPnP function, or the self check).

### 2.11.4 Reset the settings/Reboot the camera [Default reset]

Click the [Default reset] tab of the “Maintenance” page. (→For menu display and how to operate, refer to page 47, page 48)

The settings and the HTML data of the camera can be initialized and reboot of the camera can be performed on this page.



**[Reset to the default (Except the network settings)]**

Click the [Execute] button to reset the settings to the default. Note that the network settings will not be reset. It is impossible to operate the camera for about 3 minutes after the initialization.

**[Load the default HTML files (setup menu).]**

Click the [Execute] button to reset the HTML files to the default. It is impossible to operate the camera for about 3 minutes after the initialization.

**[Reset to the default and load the default HTML files.]**

Click the [Execute] button to reset the settings of the camera and the HTML files to the default. Note that the network settings will not be reset. It is impossible to operate the camera for about 3 minutes after the initialization.

**[Reboot]**

Click the [Execute] button to reboot the camera. It is impossible to operate the camera for about 2 minutes after rebooting the camera.

**[Position refresh]**

The camera position can be refreshed.

When the camera has moved from the correct home/preset position during normal use, or when it has been inadvertently moved while turning on the power of the camera, use this function to correct the camera position. It is impossible to operate the camera during the position refresh process for about 2 minutes.

**IMPORTANT**

- The direction of the camera may be accidentally changed when the camera is installed. When registering presets after the installation, we recommend performing position refresh.

**Note**

- Refer to the Important Information in the supplied CD-ROM for more information about initializing the network settings. (→Page 185)
- If “Diag.” of the alarm or e-mail notification function is selected, a notification of error will be sent to “Destination E-mail address” or to “Destination of notification” when an error such as no SD memory card insertion after the reboot or a locked SD memory card insertion occurs. (→page 191, page 172)

## 2.11.5 Settings data/backing up or restoring logs [Data]

Click the [Data] tab of the “Maintenance” page. (→For menu display and how to operate, refer to page 47, page 48)

## 2 Settings

The settings related to backing up or restoring settings data, and saving logs can be configured in this section.

The screenshot shows a web interface with a dark theme. At the top, there are navigation tabs: 'System log', 'Upgrade', 'Status', 'Default reset', and 'Data' (which is selected). Below the tabs, there are two main sections: 'Backup' and 'Restore'.  
The 'Backup' section contains three rows, each with a label on the left and an 'Execute' button on the right:  
- 'Setup data' with an 'Execute' button.  
- 'Scene file' with an 'Execute' button.  
- 'Logs' with an 'Execute' button.  
The 'Restore' section contains two rows, each with a label on the left, a 'Browse...' button, and an 'Execute' button:  
- 'Setup data' with a 'Browse...' button, two radio buttons (the first is selected), and an 'Execute' button.  
- 'Scene file' with a 'Browse...' button and an 'Execute' button.  
At the bottom of the 'Restore' section, there is a message box: 'It will take around 2 minutes to complete restoring data. Please wait and do not operate the browser during this process.'

### Backup

#### [Setup data]

Click the [Execute] button to backup the setup data of the camera to a PC.

#### [Scene file]

Click the [Execute] button to backup the scene files of the camera to a PC.

#### [Logs]

Click the [Execute] button to backup the log data of the camera to a PC.

### IMPORTANT

- When backing up settings or logs, creating the backup files takes time.
- When the backup operation takes 10 minutes or more, a communication timeout may occur. In this case all of the backup data may not be obtained. Therefore, we recommend completing backup operations within 10 minutes. It is also possible to check whether or not the correct data was obtained by restoring the obtained data (excluding log data).

### Restore

#### [Setup data]

Press the [Browse...] button and select the setup data files to restore.

Click the radio button respective to the desired option to determine whether or not to also restore network related setting contents.

Click the [Execute] button to start restoring. Do not perform operations until the restoration is complete. (The camera will be rebooted when the restoration is complete.)

Make sure to set the file name of setup data files used when restoring to "model name.dat". (The model name must be written in lower case letters and "WV-" is not needed.)

### **[Scene file]**

Press the [Browse...] button and select the scene files to restore.

Click the [Execute] button to start restoring. Do not perform operations until the restoration is complete.

Make sure to set the file name of scene file data used when restoring to "model name.txt". (The model name must be written in lower case letters and "WV-" is not needed.)

## 3 Others

### 3.1 Using the CD-ROM

#### 3.1.1 About the CD launcher

By inserting the provided CD-ROM into the CD-ROM drive of your PC, the CD launcher is automatically started and the license agreement is displayed. Read the agreement and select “I accept the terms in the license agreement”, and then click “OK”.

The CD launcher window is displayed.

- If the launcher window is not displayed, double click the “CDLauncher.exe” file on the CD-ROM.

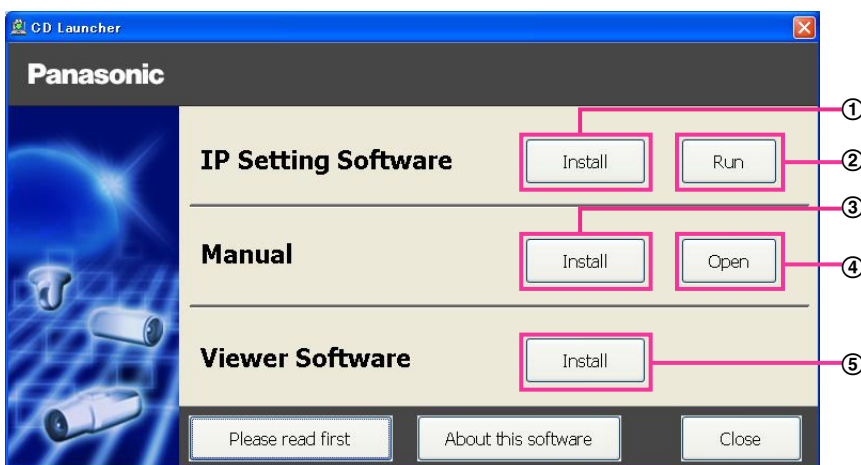

Using the supplied CD-ROM, the following actions can be performed.

- ① The Panasonic “IP Setting Software” can be installed on the PC. (→page 249)
- ② Settings related to the camera’s network can be set from the Panasonic “IP Setting Software”. (→page 251)
- ③ The manuals can be installed on the PC. (→page 250)
- ④ You can also view the manuals without installing them to the PC by clicking the [Open] button.
- ⑤ The Viewer software can be installed on the PC. (→page 250)



### 3.1.2 Installing Panasonic “IP Setting Software”

On the CD launcher window, click the [Install] button next to [IP Setting Software] to display the Panasonic “IP Setting Software” installation window. Confirm the following settings before starting the installation.

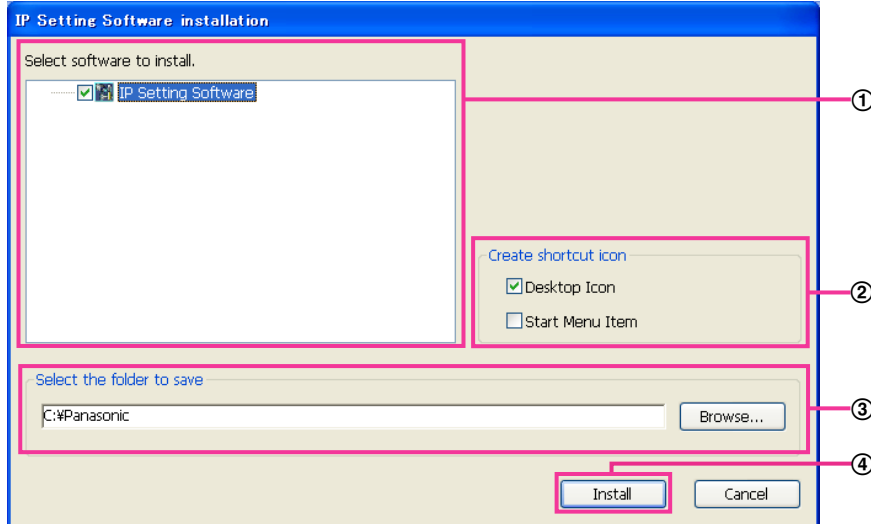

- ① Select the Panasonic “IP Setting Software” to install.
- ② Select where to create the Panasonic IP setting shortcut icon when the Panasonic “IP Setting Software” is installed.
- ③ Specify which folder on the PC to install the Panasonic “IP Setting Software” to.
- ④ Click the [Install] button to start the installation.

#### Note

- To uninstall the Panasonic “IP Setting Software” delete the shortcut icon from where you specified it to be installed (the default is on the desktop) during installation and the [EasyIPConfig] folder from the folder (the default is C:\Panasonic) you specified during installation.

### 3.1.3 Installing the manuals

On the CD launcher window, click the [Install] button next to [Manual] to display the Manual installation window. Confirm the following settings before starting the installation.

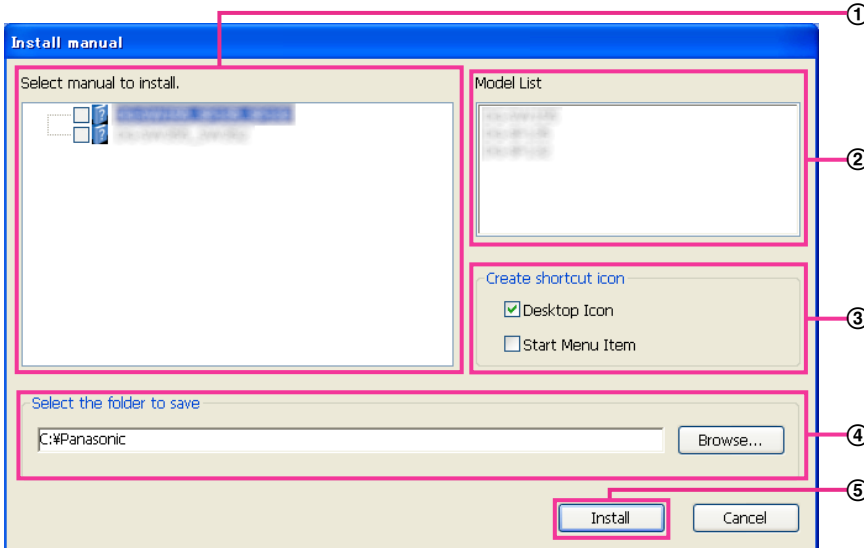

- ① Select which manuals to install. The camera models that the manuals support are displayed in ② “Model List”.
- ② The camera models that are supported by the manuals selected in ① are displayed here.
- ③ Select where to create the manuals shortcut icon when the manuals are installed.
- ④ Specify which folder on the PC to install the manuals to.
- ⑤ Click the [Install] button to start the installation.

**Note**

- To uninstall the manuals delete the shortcut icon from where you specified it to be installed (the default is on the desktop) during installation and the [Manual] folder from the folder (the default is C:\Panasonic) you specified during installation.

### 3.1.4 Installing the Viewer software

In order to display H.265 (or H.264) images, send/receive audio to/from the camera, and display logs or play images saved on the SD memory card, the “Network Camera View 4S” (ActiveX) viewer software must be installed. On the CD launcher window, click the [Install] button next to [Viewer Software], and follow the instructions displayed on the window to install the software. A message is displayed if a PC that does not have the Viewer software installed tries to access the camera. Install the software by following the instructions displayed on the window. Refer to page 4 for further information.

**Note**

- To uninstall the Viewer software, follow the steps below depending on the OS used on your PC. Delete [Network Camera View 4S] from [Control Panel] - [Programs] - [Uninstall a program].

### 3.1.5 Configure the network settings of the camera using the Panasonic “IP Setting Software”

It is possible to perform the network settings of the camera using the “IP Setting Software” on the provided CD-ROM. When using multiple cameras, it is necessary to configure the network settings of each camera independently. If the Panasonic “IP Setting Software” does not work, access the “Network” page from the setup menu of the camera in the browser and perform settings separately. (→page 185)

#### **IMPORTANT**

- The “Windows Security Alert” window may be displayed when starting the “IP Setting Software”. In this case, disable “User Account Control” from the control panel.
  - Panasonic “IP Setting Software” is inoperable in other subnets via the same router.
  - This camera cannot be displayed or set with an older version of the “IP Setting Software” (version 2.xx).
  - Due to security enhancements in “IP Setting Software”, “Network Settings” of the camera to be configured cannot be changed when around 20 minutes have passed after turning on the power of the camera. (When the effective period is set to “20min” in the “Easy IP Setup accommodate period”.) However, settings can be changed after 20 minutes for cameras in the initial set mode.
1. To start the Panasonic “IP Setting Software”, click the [Run] button next to [IP Setting Software] from the CD launcher menu window, or double-click on the shortcut icon created after installing the software on the PC.
    - The License Agreement will be displayed. Read the Agreement and choose “I accept the terms in the license agreement”, and click [OK].
    - The “Panasonic IP Setting Software” screen is displayed. If a camera is found, information about it, such as the MAC address and IP address, is displayed.
  2. Click the [Access Camera] button after selecting the MAC address/IP address of the camera to be configured.

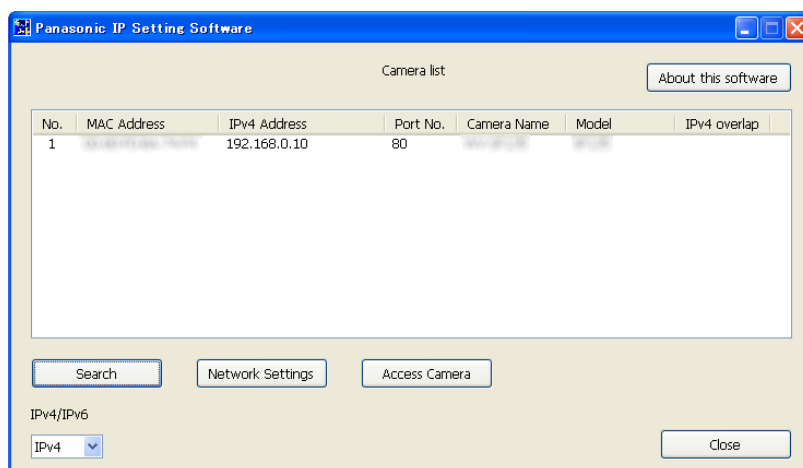

#### **Note**

- When using a DHCP server, the IP address assigned to the camera can be displayed by clicking the [Search] button of the “IP Setting Software”.
- When duplicate IP addresses are used, the number of the camera with the duplicate address is displayed in overlap.
- The displayed camera information is not automatically updated. Click the [Search] button to update the information.
- It is possible to change the “Camera list” display between IPv4 addresses and IPv6 addresses in accordance with the protocol in use.

- The information displayed can be sorted by clicking the title of each displayed item.
  - When the [Network Settings] button is clicked, the “Network Settings” screen is displayed and network settings can be changed. For further information, refer to page 252.
3. When the viewer software “Network Camera View 4S” installation screen is displayed, follow the on-screen instructions to install the software. (The viewer software “Network Camera View 4S” is installed from the camera.)
- The “Live” page of the camera is displayed.
  - If the viewer software “Network Camera View 4S” cannot be installed or images are not displayed, click the [Install] button next to [Viewer Software] from the CD launcher window to install the software.

### Changing Network Settings

When changing settings related to the network settings, such as connection mode, IP address, and subnet mask, click the [Network Settings] button in “Panasonic IP Setting Software” screen. The “Network Settings” screen is displayed. Enter each item and then click the [Save] button.

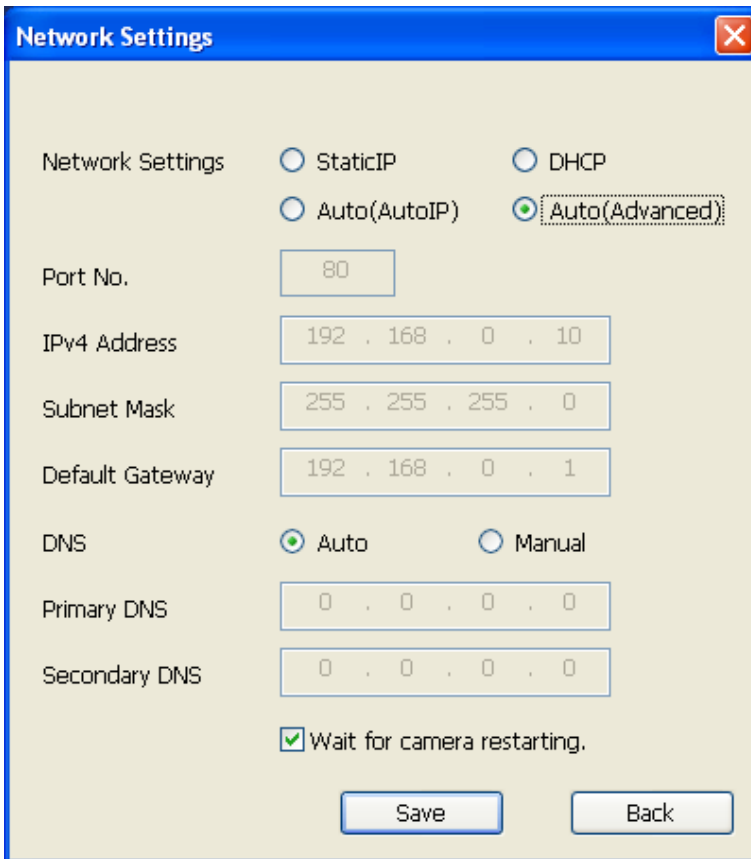

#### Note

- By unchecking the “Wait for camera restarting.” checkbox, multiple cameras can be continuously configured.
- For further information about each setting of the “Network Settings” page, refer to page 185.

### IMPORTANT

- It may take for around 2 minutes to complete to upload the settings to the camera after clicking the [Save] button. The settings may be invalidated when the LAN cable is disconnected before completing the upload. In this case, perform the settings again.

- When using a firewall (including software), allow access to all UDP ports.

## 3.2 About the displayed system log

### Error indications relating to SMTP

Category	Indication	Description
POP3 server error	Authentication error.	<ul style="list-style-type: none"> <li>Entered user name or password may be incorrect. Check if the E-mail settings are configured correctly.</li> </ul>
	Failed to find the POP3 server.	<ul style="list-style-type: none"> <li>The IP address of the server may be incorrect. Check if the IP address of the server is configured correctly.</li> <li>The POP3 server may be down. Ask the network administrator.</li> </ul>
SMTP server error	Authentication error.	<ul style="list-style-type: none"> <li>Entered user name or password may be incorrect. Check if the E-mail settings are configured correctly.</li> </ul>
	Failed to resolve the E-mail server address from DNS.	<ul style="list-style-type: none"> <li>The designated IP address of the DNS may be incorrect. Check if the DNS settings are configured correctly.</li> <li>The DNS server may be down. Ask the network administrator.</li> </ul>
	Failed to find the SMTP server.	<ul style="list-style-type: none"> <li>The IP address of the server may be incorrect. Check if the IP address of the server is configured correctly.</li> <li>The SMTP server may be down. Ask the network administrator.</li> </ul>
Internal error	Undefined error.	<ul style="list-style-type: none"> <li>An error occurred in the E-mail function. Check if the E-mail settings are configured correctly.</li> </ul>

### Error indications relating to FTP

Category	Indication	Description
FTP server error	Failed to resolve the FTP server address from DNS.	<ul style="list-style-type: none"> <li>The FTP server may be down. Ask the network administrator.</li> </ul>
	Failed to find the FTP server.	<ul style="list-style-type: none"> <li>The IP address of the server may be incorrect. Check if the IP address of the server is configured correctly.</li> </ul>
Connection error	File transfer error.	<ul style="list-style-type: none"> <li>The FTP server settings may be incorrect. Check if the FTP settings are configured correctly.</li> </ul>
	Passive mode error.	<ul style="list-style-type: none"> <li>The settings relating to the indicated item may be incorrect. Check if the FTP settings are configured correctly.</li> </ul>
	Log out failed.	
	Failed to change the directory.	
	User name or password isn't correct.	

Category	Indication	Description
Internal error	Undefined error.	<ul style="list-style-type: none"> <li>An error occurred in the FTP function. Check if the FTP settings are configured correctly.</li> </ul>

### Error indications relating to “Viewnetcam.com”

Category	Indication	Description
Access test error	Access test failed	<ul style="list-style-type: none"> <li>Port forwarding may not be configured for the router. Refer to the manuals provided with the router in use to enable the UPnP setting.</li> </ul>
Viewnetcam.com server error	Failed to resolve the Viewnetcam.com server address from DNS.	<ul style="list-style-type: none"> <li>The designated IP address of the DNS may be incorrect. Check if the DNS settings are configured correctly.</li> <li>The DNS server may be down. Ask the network administrator.</li> </ul>
Connection error	No response from the Viewnetcam.com server.	<ul style="list-style-type: none"> <li>The “Viewnetcam.com” server may be down. Ask the network administrator.</li> </ul>
	File transfer error.	
Internal error	Undefined error.	<ul style="list-style-type: none"> <li>An error relating to the “Viewnetcam.com” function occurred. Check if the “Viewnetcam.com” settings are configured correctly.</li> </ul>

### Error indications relating to Dynamic DNS Update

Category	Indication	Description
DDNS server error	Failed to resolve the DDNS server address from DNS.	<ul style="list-style-type: none"> <li>The designated IP address of the DNS may be incorrect. Check if the DNS settings are configured correctly.</li> <li>The DNS server may be down. Ask the network administrator.</li> </ul>
Connection error	No response from the DDNS server.	<ul style="list-style-type: none"> <li>The DDNS server may be down. Ask the network administrator.</li> </ul>
	Same host name has registered.	<ul style="list-style-type: none"> <li>The same host name has already been registered in the DDNS server. Check if the DDNS Update settings are configured correctly.</li> </ul>
Internal error	Undefined error.	<ul style="list-style-type: none"> <li>An error occurred in the DDNS function. Check if the DDNS Update settings are configured correctly.</li> </ul>

## Error indications relating to NTP

Category	Indication	Description
Connection error	No response from the NTP server.	<ul style="list-style-type: none"> <li>The IP address of the server may be incorrect. Check if the IP address of the server is configured correctly.</li> <li>The NTP server may be down. Ask the network administrator.</li> </ul>
Internal error	Undefined error.	<ul style="list-style-type: none"> <li>An error occurred in the NTP function. Check if the NTP settings are configured correctly.</li> </ul>
Synchronizing with NTP succeeded.	NTP update succeeded.	<ul style="list-style-type: none"> <li>Time correction succeeded.</li> </ul>

## Log indications relating to HTTPS

Category	Indication	Description
HTTPS	Certificate Signing Request - Generated	<ul style="list-style-type: none"> <li>Generation of the CSR (Certificate Signing Request) is complete.</li> </ul>
	CA Certificate - Installed	<ul style="list-style-type: none"> <li>Installation of the CA certificate is complete.</li> </ul>
	CA Certificate - Deleted	<ul style="list-style-type: none"> <li>Deletion of the CA certificate is complete.</li> </ul>
	Previous CRT key - Applied	<ul style="list-style-type: none"> <li>Previous CRT key is applied.</li> </ul>
	CRT key - Generated	<ul style="list-style-type: none"> <li>Generation of the CRT key is complete.</li> </ul>

## Log indications relating to login

Category	Indication	Description
Login	User name or IP address	<ul style="list-style-type: none"> <li>The login user name will be displayed when "On" is selected for "User auth."</li> <li>The IP address of the PC currently accessing to the camera will be displayed when "On" is selected for "Host auth."</li> </ul>



## Error indications relating to Panasonic alarm protocol notification

Category	Indication	Description
Panasonic alarm protocol notification error	Failed to find destination of notification.	<ul style="list-style-type: none"> <li>The IP address of the destination of notification may be incorrect. Check if the IP address of the destination of notification is configured correctly.</li> <li>The destination of notification may be down. Ask the network administrator.</li> </ul>
	Failed to resolve destination addr. from DNS.	<ul style="list-style-type: none"> <li>The DNS server settings may be incorrect. Check if the DNS settings are configured correctly.</li> <li>The DNS server may be down. Ask the network administrator.</li> </ul>

## Error indications relating to HTTP alarm notification

Category	Indication	Description
HTTP alarm notification error	Failed to find destination of notification.	<ul style="list-style-type: none"> <li>The IP address of the destination of notification may be incorrect. Check if the IP address of the destination of notification is configured correctly.</li> <li>The destination of notification may be down. Ask the network administrator.</li> </ul>
	Failed to resolve destination addr. from DNS.	<ul style="list-style-type: none"> <li>The DNS server settings may be incorrect. Check if the DNS settings are configured correctly.</li> <li>The DNS server may be down. Ask the network administrator.</li> </ul>

## Error indications relating to SD memory card security settings

Category	Indication	Description
SD memory card	Certificate Signing Request - Generated	<ul style="list-style-type: none"> <li>Generation of the CSR (Certificate Signing Request) is complete.</li> </ul>
	CA Certificate - Installed	<ul style="list-style-type: none"> <li>Installation of the CA certificate is complete.</li> </ul>
	CA Certificate - Deleted	<ul style="list-style-type: none"> <li>Deletion of the CA certificate is complete.</li> </ul>
	Previous CRT key - Applied	<ul style="list-style-type: none"> <li>Previous CRT key is applied.</li> </ul>
	CRT key - Generated	<ul style="list-style-type: none"> <li>Generation of the CRT key is complete.</li> </ul>

Indications relating to power device connection X6531 X6511 S6530

Category	Indication	Description
Power supply	<PoE+/24VAC> Hardware detection is detected. Operating on PoE+/24VAC.	<ul style="list-style-type: none"> <li>• Connection to 24 V AC power, PoE feeding device (injector), or the PoE+ power for hardware is detected.</li> </ul>
	<PoE+> Software detection on LLDP is detected. Operating on PoE+.	<ul style="list-style-type: none"> <li>• Connection to the PoE+ power for software detection is detected.</li> </ul>
	<PoE+/24VAC> Detection error. Operating on PoE Class 0.	<ul style="list-style-type: none"> <li>• Failed to detect a connection to 24 V AC power or the PoE+ power. Check whether the power supply device in use is compatible with PoE+ (IEEE802.3at compliant). Or use 24 V AC power supply.</li> </ul>

## 3.3 Troubleshooting

**Before asking for repairs, check the symptoms with the following table.**

Contact your dealer if a problem cannot be solved even after checking and trying the solution in the table or a problem is not described below.

Symptom	Cause/solution	Reference pages
Cannot access from the web browser.	<ul style="list-style-type: none"> <li>Is the LAN cable (category 5e or better) firmly connected to the network connector of the camera?</li> </ul>	Important Information
	<ul style="list-style-type: none"> <li>Is the status indicator lit in green? When it is not lit, connection to a LAN may not be established or a network may not be working correctly. Check if the cables have any contact failure or if the wiring is correct or not.</li> </ul>	Important Information
	<ul style="list-style-type: none"> <li>Is the power of the camera on? Check if the power of the camera is turned on.</li> </ul>	Important Information
	<ul style="list-style-type: none"> <li>Are the set IP addresses valid?</li> </ul>	185
	<ul style="list-style-type: none"> <li>Are you accessing the wrong IP address? Check the connection as follows. With the Windows command prompt, &gt; ping "IP address of the camera". If there is reply from the camera, the connection is normal. If there is no reply, check the connection with the following methods using a computer connected to the same network as the camera. If the firewall settings on the PC are enabled, temporarily disable them before performing settings on the camera. <ul style="list-style-type: none"> <li>Start the Panasonic "IP Setting Software", confirm the camera's IP address, and then access that IP address.</li> <li>If the network settings (IP address, subnet mask, and default gateway) are incorrect, reboot the camera and change the network settings by using the Panasonic "IP Setting Software" within 20 minutes after the restart.</li> <li>In networks that do not have a DHCP server, the IP address of the camera will be configured to "192.168.0.10" when the camera is rebooted by holding the INITIAL SET switch on the camera. After the camera is initialized, access the camera and set the IP address again. (When the camera is initialized, all the settings of the camera previously configured on the setup menu will be initialized.)</li> </ul> </li> </ul>	251

Symptom	Cause/solution	Reference pages
	<ul style="list-style-type: none"> <li>Is “554” selected for the HTTP port number? For the HTTP port number, select a port number other than the following port numbers used by the camera. The number used by the camera: 20, 21, 23, 25, 42, 53, 67, 68, 69, 110, 123, 161, 162, 443, 554, 995, 10669, 10670, 59000 - 61000</li> </ul>	188
	<ul style="list-style-type: none"> <li>Is the same IP address provided to other devices? Are there contradictions between the address and the network subnet to be accessed? <b>When the camera and the PC are connected in the same subnet:</b> Are the IP addresses of the camera and the PC set in a common subnet? Or is “Use Proxy Server” for the settings of the web browser checked? When accessing the camera in the same subnet, it is recommended to enter the address of the camera in the “Don’t Use Proxy For These Addresses” box. <b>When the camera and the PC are connected in the different subnet:</b> Is the IP address of the default gateway set for the camera correct?</li> </ul>	-
	<ul style="list-style-type: none"> <li>Is the name currently used to access the camera different from the name registered for the “Viewnetcam.com” service? Access the camera again with the registered name.</li> </ul>	228
	<ul style="list-style-type: none"> <li>Did you access “http://” while using the HTTPS function? To use the HTTPS function, access “https://”. It is also necessary to enter the port number.</li> </ul>	220 225
	<p>Cannot access the camera via the Internet.</p>	<ul style="list-style-type: none"> <li>Are the network settings of the camera correct? Set the default gateway or DNS server address correctly. To use the DDNS service, check that the settings are correct.</li> <li>Is the setting for “Default gateway” on the “Network” page configured? Or is the setting correct? <b>When communicating using IPv4:</b> Configure the setting for “Default gateway” of “IPv4 network” on the [Network] tab of the setup menu.</li> </ul>

Symptom	Cause/solution	Reference pages
	<ul style="list-style-type: none"> <li>• Is the setting of port forwarding configured for the router? To enable the access to the camera via the Internet, it is necessary to perform the port forwarding setting when the router in use does not support the UPnP function. Refer to the manuals provided with the router for further information.</li> <li>• Is UPnP function of the router disabled? Refer to the manuals provided with the router in use to enable the UPnP function.</li> <li>• Is packet filtering set for the router to forbid the access via the Internet? Configure the settings of the router in use to enable the access via the Internet. Refer to the manuals provided with the router for further information about the settings.</li> </ul>	201
	<ul style="list-style-type: none"> <li>• Are you accessing the camera using the local address (the IP address used in a local network)? When accessing the camera, use the global address (or the URL registered in the DDNS service) and the port number of the camera as the IP address to be used in the Internet.</li> </ul>	186 187 226
Cannot access the camera via the URL of the "Viewnetcam.com" service.	<ul style="list-style-type: none"> <li>• Is the global address of camera (or router) notified to the "Viewnetcam.com" service server? Log into the "My Account" page of "Viewnetcam.com" website (<a href="http://www.viewnetcam.com/">http://www.viewnetcam.com/</a>) to check the information of the registered camera. If the global address is not displayed for the IP address, access the camera, and register the user information for the "Viewnetcam.com" service on the [Advanced] tab on the "Network" page of the setup menu. In addition, check the "Status" of "Viewnetcam.com" (on the [Status] tab) and the system log (on the [System log] tab) of the "Maintenance" page of the setup menu.</li> </ul>	228 241
Authentication window is displayed repeatedly.	<ul style="list-style-type: none"> <li>• Is the user name and password changed? While accessing the camera, when changing the user name and password of another user logging into the camera on another web browser, the authentication window will be displayed each time the screen is changed or refreshed. Close the browser and access the camera again.</li> <li>• Have you changed the [Authentication] setting? When the [Authentication] setting has been changed, close the web browser, and then access the camera again.</li> </ul>	-

### 3 Others

Symptom	Cause/solution	Reference pages
It takes time to display the screen.	<ul style="list-style-type: none"> <li>Are you accessing the camera in the HTTPS mode? In this mode, the refresh interval becomes slower due to decode procession.</li> </ul>	-
	<ul style="list-style-type: none"> <li>Are you accessing another camera in the same local network via a proxy server? Configure the web browser to not use the proxy server.</li> </ul>	-
	<ul style="list-style-type: none"> <li>Are two or more users browsing the camera images simultaneously? It may take time to display the screen or refresh interval may become slower when two or more users browse the camera images simultaneously.</li> </ul>	-
Cannot access the camera from a cellular phone.	<ul style="list-style-type: none"> <li>Is the URL correct? Or is "/mobile" missing at the end of the URL? Check if the URL is entered correctly. When accessing the camera from a cellular phone, it is necessary to enter "/mobile" at the end of the URL that is used for the camera access from a PC.</li> </ul>	21
	<ul style="list-style-type: none"> <li>Is the SSL encryption method different from that of the camera? Select "HTTP" (Do not select "HTTPS") for "HTTPS" - "Connection" on the "Network" page - the [Advanced] tab, and access the camera again.</li> </ul>	203
	<ul style="list-style-type: none"> <li>Did you access "http://" while using the HTTPS function? To use the HTTPS function, access "https://". It is also necessary to enter the port number.</li> </ul>	220
Cannot access the camera from a mobile terminal.	<ul style="list-style-type: none"> <li>Is the URL correct? Or is "/cam" missing at the end of the URL? Check if the URL is entered correctly. When accessing the camera from a mobile terminal, it is necessary to enter "/cam" at the end of the URL that is used for the camera access from a PC.</li> </ul>	23
	<ul style="list-style-type: none"> <li>Is the SSL encryption method different from that of the camera? Select "HTTP" (Do not select "HTTPS") for "HTTPS" - "Connection" on the "Network" page - the [Advanced] tab, and access the camera again.</li> </ul>	203
	<ul style="list-style-type: none"> <li>Did you access "http://" while using the HTTPS function? To use the HTTPS function, access "https://". It is also necessary to enter the port number.</li> </ul>	220
A cookie error was displayed when performing user registration for "Viewnetcam.com".	<ul style="list-style-type: none"> <li>Is the web browser configured to allow cookies? Configure the web browser to allow cookies. In Internet Explorer, from [Tools] select [Internet Options] and configure the cookies setting in the [Privacy] tab.</li> </ul>	-

Symptom	Cause/solution	Reference pages
User registration for the "Viewnetcam.com" service fails.	<ul style="list-style-type: none"> <li>Is the registered E-mail address correct? When an E-mail with the "Viewnetcam.com" website link is not received, the registered E-mail address may be incorrect. Visit the "Viewnetcam.com" website (<a href="http://www.viewnetcam.com/">http://www.viewnetcam.com/</a>) to register the correct E-mail address.</li> </ul>	-
Cannot obtain images on the SD memory card.	<ul style="list-style-type: none"> <li>Is "Allow" selected for "FTP access to camera" on the [Network] tab of "Network" page? It is necessary in advance to select "Allow" for "FTP access to camera" on the [Network] tab of the "Network" page.</li> </ul>	190
	<ul style="list-style-type: none"> <li>Is the entered password correct? Restart the web browser and enter the password again.</li> </ul>	91
	<ul style="list-style-type: none"> <li>Access to the SD memory card may be failed. Restart the web browser and retry to obtain images.</li> </ul>	-
No image is displayed.	<ul style="list-style-type: none"> <li>Is the viewer software installed on the PC? Install the viewer software on a PC.</li> </ul>	4
	<ul style="list-style-type: none"> <li>Is the cellular phone in use support the 320×240 or 640×480 resolution? Or is the image data size too big to display images on the cellular phone? Refer to the manuals provided with the cellular phone in use for the restrictions of image data sizes.</li> </ul>	-
No image is displayed. / Older images or logs are displayed.	<ul style="list-style-type: none"> <li>When [Every time I visit the webpage] is not selected for [Check for newer versions of stored pages:] in the [Temporary Internet Files] section, images sometimes may not be displayed on the "Live" page. In this case, do the following. <ol style="list-style-type: none"> <li>Select [Internet Options...] from [Tools] on the menu bar of Internet Explorer. The [Internet Options] window will be displayed.</li> <li><b>When using Internet Explorer 10 or Internet Explorer 11:</b> Click the [Settings] button in the [Browsing history] section on the [General] tab, and then select [Every time I visit the webpage] for [Check for newer versions of stored pages:] in the [Temporary Internet Files] tab on the [Website Data Settings] window. <b>When using Internet Explorer 8 or Internet Explorer 9:</b> Click the [Settings] button in the [Browsing history] section on the [General] tab, and then select [Every time I visit the webpage] for [Check for newer versions of stored pages:] in the [Temporary Internet Files] section on the [Temporary Internet Files and History Settings] window.</li> </ol> </li> </ul>	-

### 3 Others

Symptom	Cause/solution	Reference pages
The camera does not face to the preset position.	<ul style="list-style-type: none"> <li>When the camera position is moved from the preset position after turning on the power of the camera, execute the position refresh function from the [Default reset] tab of the "Maintenance" page. When "Position refresh" is set for the created schedule, the camera position will be corrected periodically.</li> </ul>	234 245
	<ul style="list-style-type: none"> <li>Is any part of the camera worn out? The driving parts may be worn out. Contact the dealer for assistance.</li> </ul>	Important Information
The camera does not automatically move to the previous position when turning on the power of the camera.	<ul style="list-style-type: none"> <li>To move the camera to the position before the power is turned on, register the position as the home position so that the camera will return to the position using the self return function when turning on the power of the camera.</li> </ul>	105
The movement of the camera automatically changes.	<ul style="list-style-type: none"> <li>Check the settings for the self return function.</li> </ul>	105
Images are displayed blurry.	<ul style="list-style-type: none"> <li>Is the focus adjusted correctly? Check if the focus is adjusted correctly.</li> </ul>	Installation Guide
The image is not being refreshed.	<ul style="list-style-type: none"> <li>Depending on the version of your browser, there might be difficulties refreshing the picture, etc.</li> </ul>	Important Information
	<ul style="list-style-type: none"> <li>Depending on the traffic of the network or the concentration of access to the camera, there might be difficulties displaying the camera picture. Request the camera picture using the web browser such as by pressing the [F5] key, etc.</li> </ul>	-
No image is displayed (or too dark).	<ul style="list-style-type: none"> <li>Is the brightness setting set at an appropriate level? Click the [Normal] button of [Brightness].</li> </ul>	12
Images are displayed washed out.	<ul style="list-style-type: none"> <li>Is the brightness setting set at an appropriate level? Click the [Normal] button of [Brightness].</li> </ul>	12
Flicker appears on the screen.	<ul style="list-style-type: none"> <li>When flicker occurs frequently, select "Indoor scene" for "Light control mode".</li> </ul>	114
Images are displayed blurry.	<ul style="list-style-type: none"> <li>Make sure that there is no dust or dirt on the dome of the camera.</li> <li>When defocusing is caused by the camera position being moved, carry out the position refresh to correct the focus.</li> </ul>	Installation Guide
	<ul style="list-style-type: none"> <li>Is "Limited" selected for "Focus Distance" in the [Cam. Function] tab? Select "Unlimited".</li> </ul>	108
The upper part of images becomes a little dark.	<ul style="list-style-type: none"> <li>When the camera is used with the tilt angle near horizontal (near 0°) or higher (0° or higher), as the camera is operated to zoom to the "Tele" side, the upper part of images may become a little dark.</li> </ul>	Important Information



Symptom	Cause/solution	Reference pages
Images are displayed blurry.	<ul style="list-style-type: none"> <li>Is there dust or dirt on the dome section? Clean the dome section.</li> </ul>	Important Information
	<ul style="list-style-type: none"> <li>Are photographic subjects hard to focus on with the auto focus function? Adjust the focus manually.</li> </ul>	14
	<ul style="list-style-type: none"> <li>Is "Limited" selected for "Focus Distance" in the [Cam. Function] tab? Select "Unlimited".</li> </ul>	108
The image refresh on the web browser is slow or the image is intermittently displayed.	<ul style="list-style-type: none"> <li>If the camera is used in a high frame rate or in the high quality, the problem may be due to the PC specifications. In that case, using the PC that meets the following may solve the problem. <ul style="list-style-type: none"> <li>CPU: Intel Core i7 6700 or more</li> <li>Memory: 8 GB dual channel (4 GBx2) or more [Example of camera setting that may cause late refresh interval or intermittent display]</li> <li>Image capture size: 1920x1080, Frame rate: 60 fps, Bit rate: 4096 kbps</li> <li>Image capture size: 1280x720, Frame rate: 60 fps, Bit rate: 3072 kbps</li> <li>Image capture size: 1280x720, Frame rate: 30 fps, Bit rate: 2048 kbps (When multiple browsers are viewed, 4 images or more)</li> </ul> </li> </ul>	-
<p>Images cannot be saved on the SD memory card.</p> <p>Failed to write/read data on the SD memory card.</p>	<ul style="list-style-type: none"> <li>Is the SD memory card inserted correctly? Check if the SD memory card is inserted correctly.</li> </ul>	Important Information
	<ul style="list-style-type: none"> <li>Is the SD memory card formatted? Format the SD memory card.</li> </ul>	83
	<ul style="list-style-type: none"> <li>Isn't the write protect switch set to "LOCK"? When the write protect switch is set to "LOCK", available size/total size indication of the SD memory card to be displayed on "Remaining capacity" of the [SD memory card] tab will be "*****MB/*****MB".</li> </ul>	-
	<ul style="list-style-type: none"> <li>Is "-----MB/-----MB" displayed on "Remaining capacity" of the [SD memory card] tab? Format the SD memory card.</li> </ul>	83
	<ul style="list-style-type: none"> <li>Is any recognition error received when the "Diag." of "E-mail notification" or "Panasonic alarm protocol" is used? Format the SD memory card.</li> </ul>	83 191 172
	<ul style="list-style-type: none"> <li>Isn't the SD memory card out of order? There are limited times to overwrite on an SD memory card. When frequently overwritten, it may be at the end of product life. It is recommended to replace the SD memory card.</li> </ul>	-

### 3 Others

Symptom	Cause/solution	Reference pages
Cannot transmit audio to the camera.	<ul style="list-style-type: none"> <li>Are the microphone and the speaker connected correctly and firmly? Confirm that they are connected correctly and firmly.</li> </ul>	Installation Guide
	<ul style="list-style-type: none"> <li>Is the viewer software installed on the PC? Confirm that the viewer software "Network Camera View 4S" is installed.</li> </ul>	4
Audio is not output from other products such as a network disk recorder or PC software package.	<ul style="list-style-type: none"> <li>Some of the products such as a network disk recorder or PC software package may not support "G.711" or "AAC-LC". Set "Audio input encoding format" of the products to "G.726 (32 kbps)."</li> </ul>	146
The alarm occurrence indication button and the SD recording status indicator on the "Live" page do not display the current status in real time.	<ul style="list-style-type: none"> <li>Is the viewer software installed on the PC? Confirm that the viewer software "Network Camera View 4S" is installed.</li> </ul>	4
	<ul style="list-style-type: none"> <li>Is "Real time" selected for "Alarm status update mode"?</li> </ul>	71
No image is displayed on the "Live" page.	<ul style="list-style-type: none"> <li>Press the [F5] key on the keyboard of the PC or click the [Live] button.</li> </ul>	12
Shortcut icon of the camera is not displayed on "Network" of the PC.	<ul style="list-style-type: none"> <li>Is the Windows component of UPnP added? Add the component to the PC in use.</li> </ul>	201
Cannot download the log list.	<ul style="list-style-type: none"> <li>Download of files using Internet Explorer may be disabled. Click "Internet Options..." on the [Tools] menu of Internet Explorer, and [Security] tab. Then, click the [Custom level...] button to open the "Security Settings" window. Under "Downloads", select "Enable" for "Automatic prompting for file downloads" (except Internet Explorer 9, Internet Explorer 10, and Internet Explorer 11). Click the [OK] button. The warning window will be displayed. Click the [Yes] button. After changing the settings, close the web browser, and then access the camera again.</li> </ul>	-
Images are not displayed or not refreshed smoothly.	<ul style="list-style-type: none"> <li>Delete temporary internet files as follows. <ol style="list-style-type: none"> <li>Select "Internet Options..." under "Tools" on the menu bar of Internet Explorer. The "Internet Options" window will be displayed.</li> <li>Click the [Delete Files...] button in the "Temporary Internet Files" section on the [General] tab.</li> </ol> </li> </ul>	-
	<ul style="list-style-type: none"> <li>The firewall function of the anti-virus software may be filtering the port of the camera. Exclude the port number of the camera from the list of the port numbers to be filtered by the anti-virus software.</li> </ul>	-

Symptom	Cause/solution	Reference pages
The status indicator does not light up.	<ul style="list-style-type: none"> <li>Is "Off" selected for "Indicator" on the "Basic" page? Select "On" for "Indicator".</li> </ul>	71
H.265 (or H.264) images are not displayed.	<ul style="list-style-type: none"> <li>When "Network Camera View 4S" is deleted from a PC on which the viewer software "Network Camera View 3" is installed, H.265 (and H.264) images will not be displayed. In this case, install "Network Camera View 4S" after deleting "Network Camera View 3".</li> </ul>	4
When displaying H.265 (or H.264) images on two or more web browser windows, images from two or more cameras are displayed in sequence on a single browser window.	<ul style="list-style-type: none"> <li>This may occur due to the display adapter and driver combination. When this has occurred, first update the driver of the display adapter to the latest version. If updating the driver does not solve the problem, adjust the hardware acceleration as follows. The following are descriptions for when Windows 7 is installed on the PC in use. This setting may not be changed depending on the network environment. <ol style="list-style-type: none"> <li>Right-click on the desktop and select "Screen resolution" from the displayed pop-up menu.</li> <li>Click "Advanced settings".</li> <li>Select the [Troubleshoot] tab and then click "Change settings".</li> <li>If the [User Account Control] dialog box is displayed, click "Yes". When logged in as a user other than the administrator, enter the password and click "Yes". Enter a user name as required.</li> <li>Move the slider for "Hardware acceleration" to the extreme left towards "None", and then click "OK".</li> </ol> </li> </ul>	-
Failed to download recorded data from the image playing screen in the browser.	<ul style="list-style-type: none"> <li>You may not be using Internet Explorer with administrator rights. After shutting down all of the open Internet Explorer windows and tabs, restart Internet Explorer by right-clicking the Internet Explorer icon in the Start menu and selecting "Run as Administrator".</li> <li>In the "Name of the destination directory for downloaded images" settings, specify a directory that general users can write to.</li> </ul>	93
When clicking the back button of the web browser, the screen is not displayed correctly.	<ul style="list-style-type: none"> <li>Press the [F5] key on the keyboard to refresh the display.</li> </ul>	-

## Information Bar

### When using Internet Explorer 9, Internet Explorer 10, or Internet Explorer 11:

The “Information Bar” (①) expressed in the following symptom and solutions will be displayed just below the address bar only when there is information to communicate.

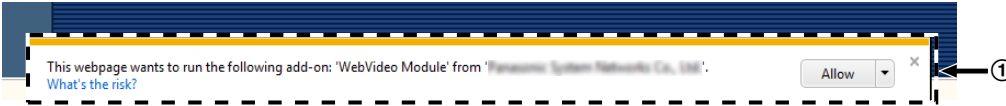

### When using Internet Explorer 8:

The “Information Bar” (②) expressed in the following symptom and solutions will be displayed just below the address bar only when there is information to communicate.



Depending on the OS installed on the PC, the following may occur. Follow the instructions below when the following has occurred. By performing the following solutions, other applications may not be affected.

Symptom	Cause/solution	Reference pages
The following message is displayed on the information bar. “Pop-up blocked. To see this pop-up or additional options, click here...” (Internet Explorer 8)	<ul style="list-style-type: none"> <li>Click the information bar and select “Always Allow Pop-ups from This Site...”. The dialog window saying “Allow pop-ups from this site?” will be displayed. Click the [Yes] button.</li> </ul>	-
The following message is displayed on the information bar. “Internet Explorer blocked a pop-up from ***.***.***.*** (IP address).” (Internet Explorer 9, Internet Explorer 10, or Internet Explorer 11)	<ul style="list-style-type: none"> <li>Select “Options for this site” → “Always allow”.</li> </ul>	-
The following message is displayed on the information bar. “This webpage wants to run the following add-on: `WebVideo Module' from `Panasonic Corporation`.” (Internet Explorer 9, Internet Explorer 10, or Internet Explorer 11)	<ul style="list-style-type: none"> <li>Select [Allow].</li> </ul>	-

Symptom	Cause/solution	Reference pages
<p>The following message is displayed on the information bar.            “This site might require the following ActiveX control 'nwc4Ssetup.exe' from 'Panasonic Corporation'. Click here to install...”            (Internet Explorer 8)</p>	<ul style="list-style-type: none"> <li>Click the information bar and select “Install ActiveX Control”.                The “Security Warning” window will be displayed. Click the [Install] button on the displayed “Security Warning” window.</li> </ul>	-
<p>The following message is displayed on the information bar.            “This webpage wants to install the following add-on: 'nwc4Ssetup.exe' from 'Panasonic Corporation'.”            (Internet Explorer 9, Internet Explorer 10, or Internet Explorer 11)</p>	<ul style="list-style-type: none"> <li>Select [Install]. The “Security Warning” window will be displayed. Click the [Install] button on the displayed “Security Warning” window.</li> </ul>	-
<p>An unnecessary status bar or scroll bar is displayed on the pop-up window.</p>	<ul style="list-style-type: none"> <li>Click “Internet Options...” under “Tools” of the menu bar of Internet Explorer, and then click the [Security] tab. Click “Internet” in the “Select a Web content zone to specify its security settings.” section. Then, click the [Custom level...] button to open the “Security Settings” window. Under “Miscellaneous”, select “Enable” for “Allow script-initiated windows without size or position constraints”. Click the [OK] button. When the warning window is displayed, click the [Yes] button.</li> </ul>	-
<p>With Windows 10, the dialog message or error message may contain a line break, or some part of the message may not be displayed.</p>	<ul style="list-style-type: none"> <li>Changing the PC setting may solve this problem. Right-click on the desktop, click “Display settings”, move the slider of “Change the size of text, apps, and other items” and change the setting.</li> </ul>	-

### 3 Others

---

Symptom	Cause/solution	Reference pages
Images are not fit in the frames.	<ul style="list-style-type: none"><li>When “120 DPI” or higher is selected for “DPI setting”, they may not be displayed correctly. <b>When using Windows 10:</b> Right-click on the desktop, click “Display settings”, and then move the slider of “Change the size of text, apps, and other items” to “100% (Recommended)”. Select “Landscape” of “Orientation”. <b>When using Windows 8.1:</b> Right-click on the desktop, click “Screen resolution” → “Make text and other items larger or smaller”, and then move the slider of “Change the size of all items” to “Smaller” so that the screen becomes the recommended size. <b>When using Windows 8/Windows 7:</b> Right-click on the desktop, click “Screen resolution” → “Make text and other items larger or smaller”, and then select “Smaller - 100% (default)”.</li></ul>	-

## 3.4 Directory structure of drive B

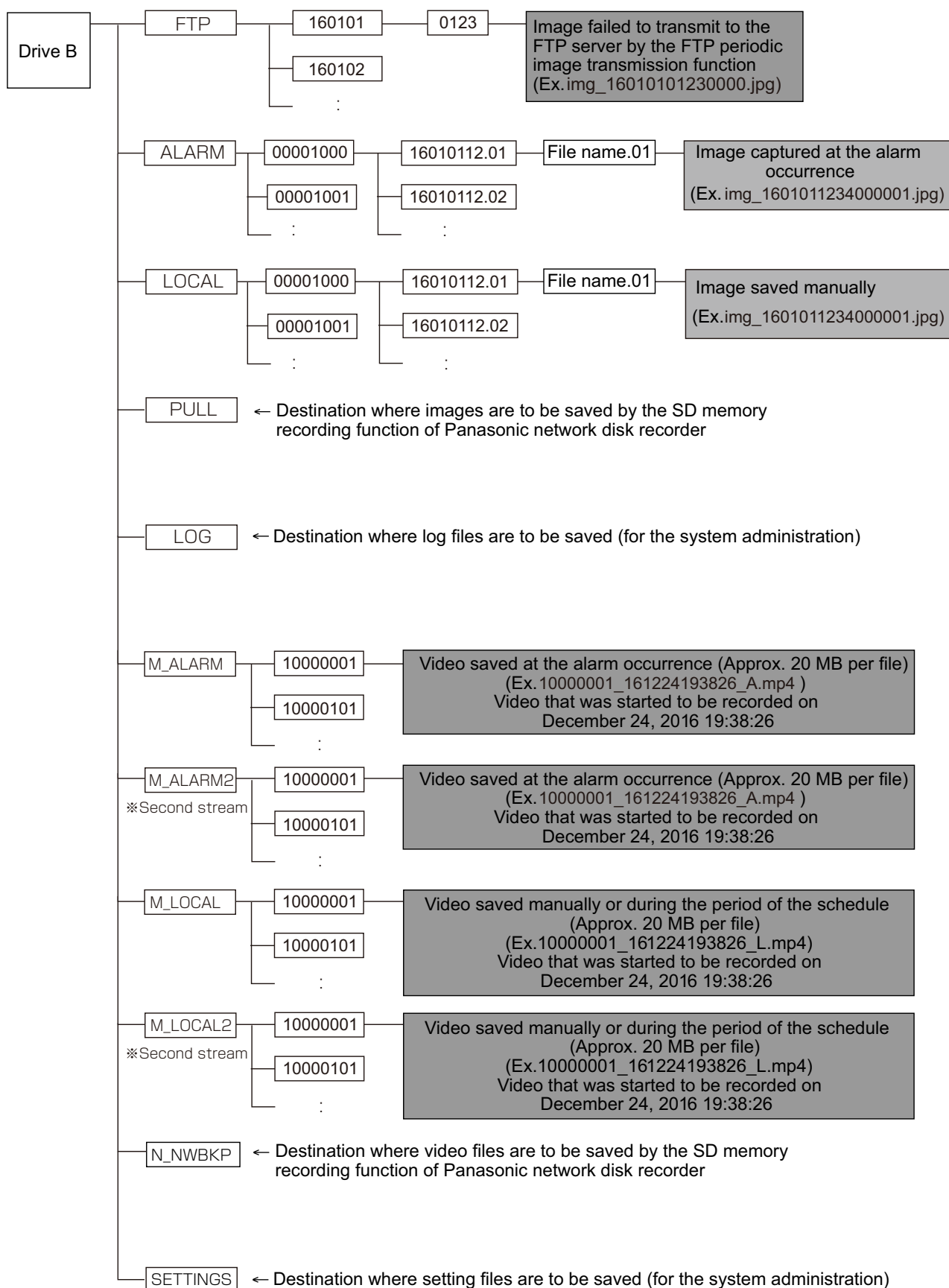

**For U.S. and Canada:**

**Panasonic i-PRO Sensing Solutions Corporation of America**

800 Gessner Rd, Suite 700 Houston, TX 77024  
<https://www.security.us.panasonic.com/>

**Panasonic Canada Inc.**

5770 Ambler Drive, Mississauga, Ontario, L4W 2T3 Canada  
1-877-495-0580  
<https://www.panasonic.com/ca/>

**For Europe and other countries:**

**Panasonic Corporation**

<http://www.panasonic.com>

Panasonic i-PRO Sensing Solutions Co., Ltd.  
Fukuoka, Japan

Authorised Representative in EU:

Panasonic Testing Centre  
Panasonic Marketing Europe GmbH  
Winsbergring 15, 22525 Hamburg, Germany

© Panasonic i-PRO Sensing Solutions Co., Ltd. 2019