

Panasonic ideas for life



S P E C F I L E



The PT-EX500L is not equipped with a lens.

Product Number : **PT-EX500/EX500L**

Product Name : LCD Projectors

Specifications

Main unit

Power supply		100–240 V AC, 50/60 Hz
Power consumption		490 W (492 VA) (0.4 W with STANDBY MODE set to ECO* ¹ , 11 W with STANDBY MODE set to NETWORK.)
Optical system		Dichroic mirror separation/prism synthesis system
LCD panel	Panel size	20.0 mm (0.8 inches) diagonal (4:3 aspect ratio)
	Display method	Transparent LCD panel (× 3, R/G/B)
	Pixels	786,432 (1,024 × 768) × 3, total of 2,359,296 pixels
	Pixel configuration	Stripe
Lens	PT-EX500	Powered zoom/focus lens (1.7–2.8:1), F 1.7–2.3, f 26.9–45.4 mm
	PT-EX500L	Optional powered zoom/focus lenses and fixed-focus lens
Lamp		330 W UHM lamp
Screen size		1.02–10.16 m (40–400 inches), 4:3 aspect ratio
Brightness* ²		5,000 lumens (LAMP POWER: AUTO/NORMAL)
Center-to-corner uniformity* ²		90%
Contrast* ²		2,000:1 (full on / full off, LAMP POWER: AUTO)
Resolution		1,024 × 768 pixels (Input signals that exceed this resolution will be converted to 1,024 × 768 pixels.)
Scanning frequency	HDMI/DVI-I	fH: 26–80 kHz, fV: 23–85 Hz, dot clock: 162 MHz or lower
	RGB	fH: 15–120 kHz, fV: 48–100 Hz, dot clock: 230 MHz or lower (Signals exceeding the dot clock rate of 140 MHz are downsampled.)
	YPbPr (YCbCr)	480i (525i): fH 15.75 kHz; fV 60 Hz, 576i (625i): fH 15.63 kHz; fV 50 Hz, 480p (525p): fH 31.50 kHz; fV 60 Hz, 576p (625p): fH 31.25 kHz; fV 50 Hz, 720 (750)/60p: fH 45.00 kHz; fV 60 Hz, 720 (750)/50p: fH 37.50 kHz; fV 50 Hz, 1035/60i: fH 33.75 kHz; fV 60 Hz, 1080 (1125)/60i: fH 33.75 kHz; fV 60 Hz, 1080 (1125)/50i: fH 28.13 kHz; fV 50 Hz, 1080/25p: fH 28.13 kHz; fV 25 Hz, 1080/25sF: fH 28.13 kHz; fV 50 Hz, 1080/24p: fH 27.00 kHz; fV 24 Hz, 1080/24sF: fH 27.00 kHz; fV 48 Hz, 1080/30p: fH 33.75 kHz; fV 30 Hz, 1080/30sF: fH 33.75 kHz; fV 60 Hz, 1080/60p: fH 67.50 kHz; fV 60 Hz, 1080/50p: fH 56.25 kHz; fV 50 Hz
	Video/S-Video	fH: 15.75 kHz, fV: 60 Hz [NTSC/NTSC4.43/PAL-M/PAL60] fH: 15.63 kHz, fV: 50 Hz [PAL/PAL-N/SECAM] NOTE: Optical axis shift function cannot be operated when used with the ET-ELW21.
Optical axis shift		Vertical: ±50% (powered), horizontal: ±10% (powered)
Keystone correction range		Vertical: ±40°
Installation		Ceiling/floor, front/rear
Built-in speaker	Size	3.7 cm (1-15/32 inches) (round) × 1
	Output power	10 W (monaural)

Terminals	<p>INPUT 1</p> <p>HDMI IN</p> <p>DVI-D IN</p> <p>RGB IN R, G, B</p> <p>INPUT 2</p> <p>[RGB input] R, G, B</p> <p>Y, Pb (Cb), Pr (Cr)</p> <p>VIDEO</p> <p>INPUT 3</p> <p>[Component input] Y, Pb (Cb), Pr (Cr)</p> <p>VIDEO</p> <p>S-VIDEO</p> <p>MONITOR OUT (RGB output)</p> <p>AUDIO IN 1</p> <p>AUDIO IN 2</p> <p>AUDIO IN 3</p> <p>VARIABLE AUDIO OUT</p> <p>SERIAL IN</p> <p>REMOTE IN</p> <p>LAN</p>	<p>Menu selection</p> <p>HDMI 19-pin × 1, Deep Color, HDCP compatible</p> <p>480p (525p), 576p (625p), 720 (750)/60p, 720 (750)/50p, 1035/60i, 1080 (1125)/60i, 1080 (1125)/50i, 1080/25p, 1080/25sF, 1080/24p, 1080/24sF, 1080/30p, 1080/30sF, 1080/60p, 1080/50p, VGA (640 × 480)–WUXGA*² (1,920 × 1,200)</p> <p>Audio signal: linear PCM (sampling frequencies: 48 kHz, 44.1 kHz, 32 kHz)</p> <p>DVI-D 24-pin × 1, DVI 1.0 compliant, compatible with HDCP, compatible with single link only</p> <p>480p (525p), 576p (625p), 720 (750)/60p, 720 (750)/50p, 1035/60i, 1080 (1125)/60i, 1080 (1125)/50i, 1080/25p, 1080/25sF, 1080/24p, 1080/24sF, 1080/30p, 1080/30sF, 1080/60p, 1080/50p, VGA (640 × 480)–WUXGA*² (1,920 × 1,200)</p> <p>D-sub HD 15-pin (female) × 1</p> <p>R: 0.7 Vp-p, 75 ohms;</p> <p>G: 0.7 Vp-p (1.0 Vp-p for sync on G), 75 ohms;</p> <p>B: 0.7 Vp-p, 75 ohms;</p> <p>HD/VD, SYNC: high impedance, TTL (positive/negative)</p> <p>NOTE: SYNC/HD and VD terminals do not accept tri-level sync signals.</p> <p>Menu selection</p> <p>BNC × 5 (RGB/YPbPr/YCbCr × 1)</p> <p>R: 0.7 Vp-p, 75 ohms;</p> <p>G: 0.7 Vp-p (1.0 Vp-p for sync on G), 75 ohms;</p> <p>B: 0.7 Vp-p, 75 ohms;</p> <p>HD/VD, SYNC: high impedance, TTL (positive/negative)</p> <p>NOTE: SYNC/HD and VD terminals do not accept tri-level sync signals.</p> <p>Y: 1.0 Vp-p (including sync signal);</p> <p>Pb (Cb), Pr (Cr): 0.7 Vp-p, 75 ohms</p> <p>BNC × 1, 1.0 Vp-p, 75 ohms</p> <p>Menu selection</p> <p>RCA pin × 3 (YPbPr/YCbCr × 1)</p> <p>Y: 1.0 Vp-p (including sync signal);</p> <p>Pb (Cb), Pr (Cr): 0.7 Vp-p, 75 ohms</p> <p>RCA pin × 1, 1.0 Vp-p, 75 ohms</p> <p>Mini DIN 4-pin × 1, Y: 1.0 Vp-p; C: 0.286 Vp-p, 75 ohms</p> <p>D-sub HD 15-pin (female) × 1</p> <p>R: 0.7 Vp-p, 75 ohms;</p> <p>G: 0.7 Vp-p (1.0 Vp-p for sync on G), 75 ohms;</p> <p>B: 0.7 Vp-p, 75 ohms;</p> <p>HD/VD, SYNC: high impedance, TTL (positive/negative)</p> <p>M3 (L, R) × 1, 0.5 Vrms, input impedance: 22 kilohms or more</p> <p>M3 (L, R) × 1, 0.5 Vrms, input impedance: 22 kilohms or more</p> <p>RCA (L, R) × 2, 0.5 Vrms, input impedance: 22 kilohms or more</p> <p>M3 (L, R) × 1 (monitor out: 0–2.0 Vrms, variable)</p> <p>D-sub 9-pin (female) × 1, for external control (RS-232C compliant)</p> <p>M3 jack × 1 for wired remote control or link control</p> <p>RJ-45 × 1, for network connection, 100Base-TX/10Base-T, compliant with PLink™</p> <p>3.0 m (9 ft 10 in)</p> <p>Molded plastic</p> <p>489.5 × 164*⁴ × 434 mm</p> <p>(19-9/32 × 6-15/32*⁴ × 17-3/32 inches) (with supplied lens)</p> <p>489.5 × 164*⁴ × 370 mm</p> <p>(19-9/32 × 6-15/32*⁴ × 14-9/16 inches) (without lens)</p> <p>Approx. 10.2 kg (22.5 lbs) (with supplied lens)</p> <p>Approx. 9.5 kg (20.9 lbs) (without lens)</p> <p>37 dB (LAMP POWER: NORMAL), 31 dB (LAMP POWER: ECO 1 / ECO 2)</p> <p>0–40 °C (32–104 °F) up to 1,000 m (3,280 ft) above sea level, with fan control set to OFF,</p> <p>0–30 °C (32–86 °F) between 1,000 m and 2,000 m (3,280 ft and 6,561 ft) above sea level, with fan control set to ON 1,</p>
Power cord length	3.0 m (9 ft 10 in)	
Cabinet materials	Molded plastic	
Dimensions (W × H × D)	<p>PT-EX500</p> <p>489.5 × 164*⁴ × 434 mm</p> <p>(19-9/32 × 6-15/32*⁴ × 17-3/32 inches) (with supplied lens)</p> <p>PT-EX500L</p> <p>489.5 × 164*⁴ × 370 mm</p> <p>(19-9/32 × 6-15/32*⁴ × 14-9/16 inches) (without lens)</p>	
Weight	<p>PT-EX500</p> <p>Approx. 10.2 kg (22.5 lbs) (with supplied lens)</p> <p>PT-EX500L</p> <p>Approx. 9.5 kg (20.9 lbs) (without lens)</p>	
Operation noise* ²	37 dB (LAMP POWER: NORMAL), 31 dB (LAMP POWER: ECO 1 / ECO 2)	
Operating temperature	<p>0–40 °C (32–104 °F) up to 1,000 m (3,280 ft) above sea level, with fan control set to OFF,</p> <p>0–30 °C (32–86 °F) between 1,000 m and 2,000 m (3,280 ft and 6,561 ft) above sea level, with fan control set to ON 1,</p>	

	0–30 °C (32–86 °F) between 2,000 m and 2,700 m (6,561 ft and 8,858 ft) above sea level, with fan control set to ON 2.
Operating humidity	20%–80% (no condensation)
Remote control unit	
Power supply	3 V DC (R03/LR03/AAA type battery × 2)
Operation range*5	Approx. 5 m (16 ft 5 in) when operated from directly in front of the signal receptor
Dimensions (W × H × D)	48 × 145 × 27 mm (1-7/8 × 5-23/32 × 1-1/16 inches)
Weight	Approx. 102 g (3.6 oz) (including batteries)
Supplied accessories	
	Power cord (× 1)
	Power cord holder (× 1)
	Wireless/wired remote control unit (× 1)
	Batteries for remote control (AAA/R03/LR03 type × 2)
	Computer cable (× 1)
	Software CD-ROM (Logo Transfer Software, Multi Projector Monitoring & Control Software) (× 1)
Optional accessories	
Zoom lens (1.3–1.7:1)	ET-ELW20
Zoom lens (2.8–4.6:1)	ET-ELT20
Zoom lens (4.6–7.2:1)	ET-ELT21
Fixed-focus lens (0.8:1)	ET-ELW21
Ceiling mount bracket	ET-PKE200H (for high ceilings)
	ET-PKE200S (for low ceilings)
Bracket assembly	ET-PKE200B
Replacement lamp unit	ET-LAE200
Replacement filter unit	ET-RFE200

Weights and dimensions shown are approximate. Specifications and appearance are subject to change without notice.

*1 When the standby mode is set to eco, network functions such as power on over the LAN network will not operate, and the serial output terminal cannot be used. Also, only certain commands can be received for external control using the serial terminal.

*2 Measurement, measuring conditions, and method of notation all comply with ISO 21118 international standards.

*3 WUXGA resolution is supported only when the signals are compliant with VESA CVT-RB (Coordinated Video Timing-Reduced Blanking).

*4 With legs at shortest position.

*5 Operation range differs depending on environments.

Dimensions

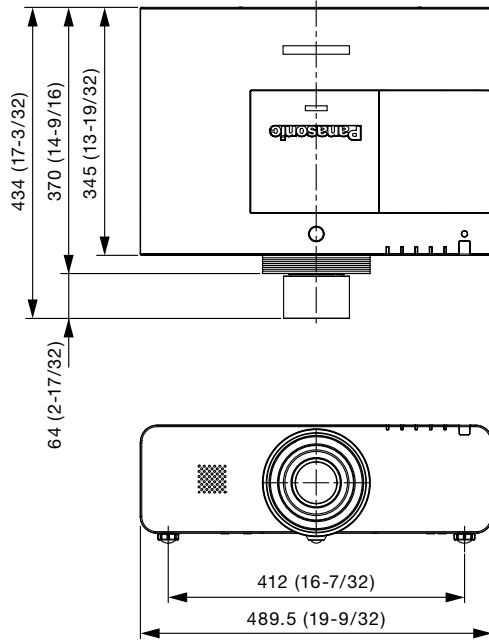

unit : mm (inch)
 NOTE: This illustration is not drawn to scale.
 The illustration shows the PT-EX500.

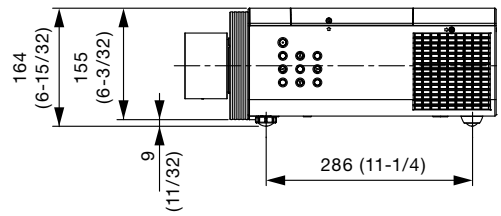

Terminals

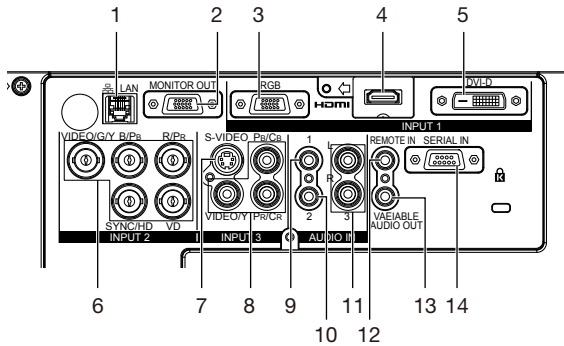

- 1 LAN connector
- 2 RGB output
- 3 RGB input
- 4 HDMI Input
- 5 DVI-D input
- 6 RGB/component/video input
- 7 S-Video
- 8 Component/video input
- 9 Audio 1 input
- 10 Audio 2 input
- 11 Audio 3 input
- 12 Remote input
- 13 Audio output
- 14 Serial input

Standard setting-up position

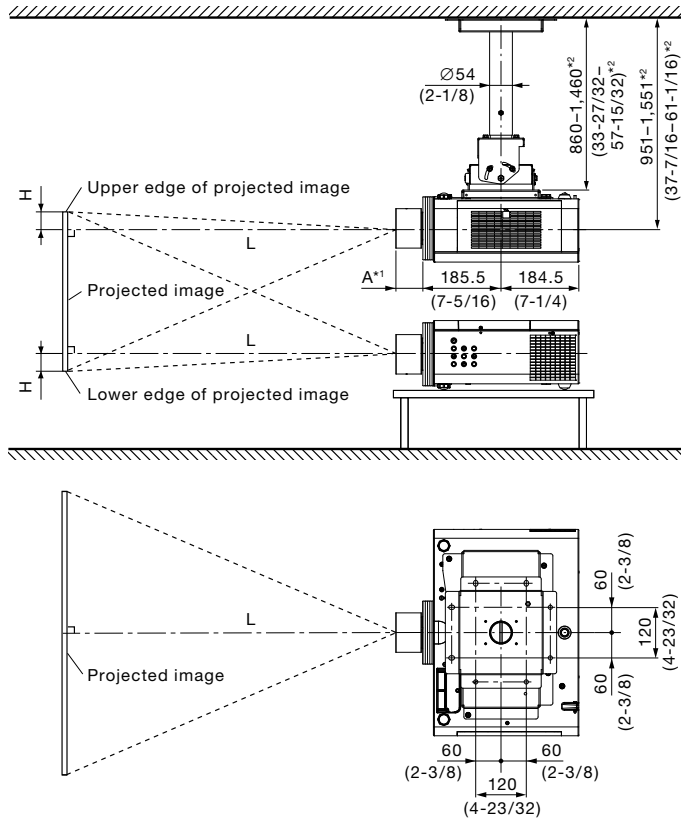

*1 When the lens protrudes to the maximum.
 A: 83.5 mm (3-9/32 in) with the ET-ELW20
 64 mm (2-17/32 in) with the supplied lens
 88 mm (3-15/32 in) with the ET-ELT20
 84 mm (3-5/16 in) with the ET-ELT21
 54 mm (2-1/8 in) with the ET-ELW21

*2 Adjustable in 30 mm (1-3/16 in) steps.

NOTE:

Illustrations show the projector installed using optional ceiling mount bracket ET-PKE200H and bracket assembly ET-PKE200B.

This illustration is not drawn to scale.

unit : mm (inch)

Caution:

- All construction work should be done by a qualified technician.
- When mounting to the ceiling, use the special mounting bracket. To prevent the projector from swaying or dropping, attach the wire between the mounting bracket and the ceiling.

Projection distance for 4:3 aspect ratio screen

Unit: meters

Screen size (diagonal)		Distance to screen (L)									Height from the edge of screen to center of lens (H)	
		Zoom								Fixed-focus		
		ET-ELW20 Zoom lens		<i>Supplied lens</i>		ET-ELT20 Zoom lens		ET-ELT21 Zoom lens				
[m]	[in]	min.	max.	min.	max.	min.	max.	min.	max.		Zoom lenses	Fixed- focus lens
1.02/	40	0.97	1.35	1.30	2.26	2.19	3.65	3.56	5.78	0.60	0 – 0.61	0.31
1.27/	50	1.23	1.70	1.64	2.83	2.77	4.59	4.50	7.27	0.77	0 – 0.76	0.38
1.52/	60	1.49	2.05	1.98	3.41	3.34	5.53	5.44	8.77	0.93	0 – 0.91	0.46
1.78/	70	1.74	2.40	2.32	3.98	3.92	6.47	6.38	10.27	1.10	0 – 1.07	0.53
2.03/	80	2.00	2.75	2.66	4.56	4.50	7.41	7.32	11.77	1.26	0 – 1.22	0.61
2.29/	90	2.26	3.10	3.00	5.14	5.07	8.35	8.27	13.26	1.43	0 – 1.37	0.69
2.54/	100	2.51	3.45	3.34	5.71	5.65	9.29	9.21	14.76	1.59	0 – 1.52	0.76
3.05/	120	3.03	4.15	4.01	6.86	6.80	11.17	11.09	17.75	1.92	0 – 1.83	0.91
3.81/	150	3.80	5.20	5.03	8.59	8.53	14.00	13.92	22.24	2.42	0 – 2.29	1.14
5.08/	200	5.08	6.95	6.73	11.47	11.41	18.70	18.63	29.73	3.24	0 – 3.05	1.52
6.35/	250	6.37	8.70	8.42	14.35	14.30	23.40	23.34	37.21	4.07	0 – 3.81	1.91
7.62/	300	7.65	10.45	10.12	17.23	17.18	28.11	28.05	44.70	4.89	0 – 4.57	2.29
10.16/	400	10.22	13.95	13.51	22.99	22.94	37.51	37.47	59.67	6.54	0 – 6.10	3.05

Unit: feet

Screen size (diagonal)		Distance to screen (L)									Height from the edge of screen to center of lens (H)	
		Zoom								Fixed-focus		
		ET-ELW20 Zoom lens		<i>Supplied lens</i>		ET-ELT20 Zoom lens		ET-ELT21 Zoom lens				
[m]	[in]	min.	max.	min.	max.	min.	max.	min.	max.		Zoom lenses	Fixed- focus lens
1.02/	40	3.2	4.4	4.3	7.4	7.2	12.0	11.7	19.0	2.0	0 – 2.0	1.0
1.27/	50	4.0	5.6	5.4	9.3	9.1	15.1	14.8	23.9	2.5	0 – 2.5	1.3
1.52/	60	4.9	6.7	6.5	11.2	11.0	18.1	17.8	28.8	3.1	0 – 3.0	1.5
1.78/	70	5.7	7.9	7.6	13.1	12.9	21.2	20.9	33.7	3.6	0 – 3.5	1.8
2.03/	80	6.6	9.0	8.7	15.0	14.8	24.3	24.0	38.6	4.1	0 – 4.0	2.0
2.29/	90	7.4	10.2	9.8	16.9	16.6	27.4	27.1	43.5	4.7	0 – 4.5	2.3
2.54/	100	8.2	11.3	10.9	18.7	18.5	30.5	30.2	48.4	5.2	0 – 5.0	2.5
3.05/	120	9.9	13.6	13.2	22.5	22.3	36.7	36.4	58.2	6.3	0 – 6.0	3.0
3.81/	150	12.5	17.0	16.5	28.2	28.0	45.9	45.7	73.0	7.9	0 – 7.5	3.8
5.08/	200	16.7	22.8	22.1	37.6	37.4	61.3	61.1	97.5	10.6	0 – 10.0	5.0
6.35/	250	20.9	28.5	27.6	47.1	46.9	76.8	76.6	122.1	13.3	0 – 12.5	6.3
7.62/	300	25.1	34.3	33.2	56.5	56.4	92.2	92.0	146.7	16.0	0 – 15.0	7.5
10.16/	400	33.5	45.8	44.3	75.4	75.3	123.1	122.9	195.8	21.5	0 – 20.0	10.0

- The value for L (distance to screen) varies slightly within ±5% depending on the zoom lens characteristics.
- The zoom lens characteristics may cause slight image distortion.
- When vertical keystone correction is used, the image is corrected in the direction that reduces its projected size.
- The brightness varies depending on the zoom setting.

Note: When the fixed-focus lens ET-ELW21 is mounted, the optical lens shift function cannot be used.

Calculation of the projection distance

For a screen size different from the above, use the equation below to calculate the projection distance.

Aspect ratio 4:3

ET-ELW20	minimum	$L (m) = (\text{diagonal screen size in inches}) \times 0.025700 - 0.055800$
	maximum	$L (m) = (\text{diagonal screen size in inches}) \times 0.035000 - 0.054000$

<i>Supplied lens</i>	<i>minimum</i>	$L (m) = (\text{diagonal screen size in inches}) \times 0.033900 - 0.055300$
	<i>maximum</i>	$L (m) = (\text{diagonal screen size in inches}) \times 0.057600 - 0.048000$

ET-ELT20	minimum	$L (m) = (\text{diagonal screen size in inches}) \times 0.057640 - 0.114200$
	maximum	$L (m) = (\text{diagonal screen size in inches}) \times 0.094060 - 0.112900$

ET-ELT21	minimum	$L (m) = (\text{diagonal screen size in inches}) \times 0.094210 - 0.213200$
	maximum	$L (m) = (\text{diagonal screen size in inches}) \times 0.149700 - 0.210900$

ET-ELW21	(fixed focus)	$L (m) = (\text{diagonal screen size in inches}) \times 0.016500 - 0.058500$
----------	---------------	--

- Distances calculated with the above equations will include a slight error.

Shift range

Optical axis shift function allows to shift the position of a projected image as shown on the right.

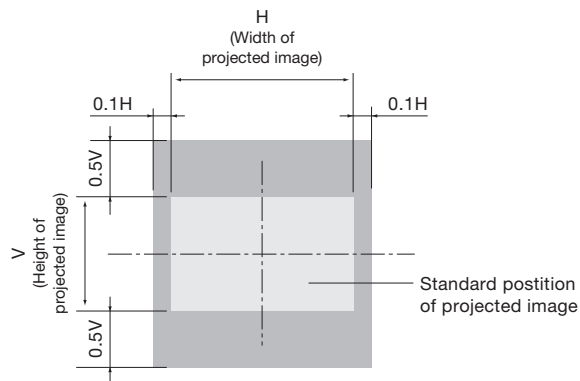

- The ET-ELW21 is a fixed short-focus lens. Therefore, the lens shift function provided in the main unit cannot be used.

Installable angle

Install the projector at an angle within the range shown below.

Vertical direction

The projector may be installed at a vertical angle of 360°.

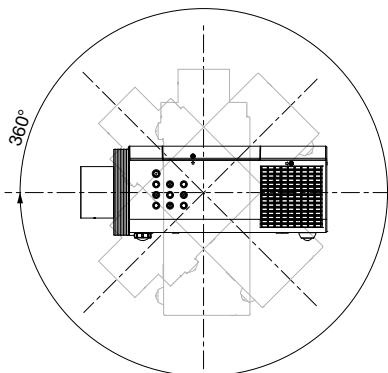

Horizontal direction

The projector may be installed at a horizontal angle of ±10°.

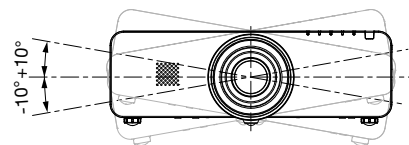

List of compatible signals

The signals that can be input to this projector are shown in the table below. Horizontal scanning frequencies of 15 kHz to 100 kHz (15 kHz to 120 kHz for RGB signals), vertical scanning frequencies of 24 Hz to 120 Hz (48 Hz to 100 Hz for RGB signals), and a dot clock of 162 MHz maximum (230 MHz maximum for RGB signals) can be input.

NOTE: The native resolution of this projector is 1,024 × 768 pixels. If the display resolution of the input signal is different from the native resolution, image compression or expansion will be used to convert the input signal to a level within the native resolution.

Display mode	Display resolution (dots) ^{*1}	Scanning frequency		Dot clock frequency (MHz)	Format
		H (kHz)	V (kHz)		
NTSC/NTSC4.43/PAL-M/PAL60	720 × 480i	15.7	59.9	–	VIDEO/S-VIDEO
PAL/PAL-N/SECAM	720 × 576i	15.6	50.0	–	
480i (525i)	720 × 480i	15.7	59.9	27.0	HDMI
576i (625i)	720 × 576i	15.6	50.0	27.0	
480p (525p)	720 × 480i	31.5	60.0	27.0	HDMI/DVI-D
576p (625p)	720 × 576i	31.3	50.0	27.0	
480i (525i)	640 × 480i	15.7	60.0	12.3	YPbPr/RGB
576i (625i)	768 × 576i	15.6	50.0	14.8	
480p (525p)	640 × 480	31.5	59.9	25.2	
576p (625p)	768 × 576	31.3	50.0	29.5	
720p	1280 × 720	37.5	50.0	74.3	HDMI/DVI-D/ YPbPr/RGB
		45.0	60.0	74.3	
1035i	1920 × 1035i	33.8	60.0	74.3	
1080i	1920 × 1080i	28.1	50.0	74.3	
		33.8	60.0	74.3	
1080p	1920 × 1080	27.0	24.0	74.3	
		28.1	25.0	74.3	
		33.8	30.0	74.3	
		56.3	50.0	148.5	
		67.5	60.0	148.5	
1080psf/30		33.8	60.0	74.3	
1080psf/25		28.1	50.0	74.3	
1080psf/24		27.0	48.0	74.3	
VGA	640 × 400	31.5	70.1	28.3	RGB
	640 × 480	31.5	59.9	25.2	HDMI/DVI-D/RGB
		37.5	75.0	31.5	RGB
		37.9	72.8	31.5	
		37.9	74.4	31.5	
		43.3	85.0	36.0	
	720 × 400	31.5	70.1	25.1	
MAC LC13	640 × 480	35.0	66.6	31.3	
MAC13		35.0	66.7	30.2	
SVGA	800 × 600	32.7	51.1	32.7	
		34.5	55.4	36.4	
		35.2	56.3	36.0	
		37.9	60.3	40.0	HDMI/DVI-D/RGB
		37.9	61.0	40.0	RGB
		38.0	60.5	40.1	
		38.6	60.3	38.6	
		46.9	75.0	49.5	
		48.1	72.2	50.0	
		53.7	85.1	56.3	
MAC16	832 × 624	49.7	74.6	57.3	
XGA	1024 × 768	43.4	60.1	65.0	HDMI/DVI-D
		44.0	54.6	59.1	RGB
		46.9	58.2	63.0	
		47.0	58.3	61.7	
		48.4	60.0	65.0	
		48.5	60.0	65.2	
		58.0	72.0	74.7	
		56.5	70.1	75.0	
		60.0	75.0	78.8	
		60.3	74.9	79.3	
		61.0	75.7	81.0	
		62.0	77.1	84.4	
		63.5	79.4	83.4	
		68.7	85.0	94.5	
	1024 × 768i	35.5	87.0	44.9	
		36.0	87.2	47.3	
MAC19	1024 × 768	60.2	75.1	80.0	

*1 The "i" appearing after the resolution indicates an interlaced signal.

Display mode	Display resolution (dots) ^{*1}	Scanning frequency		Dot clock frequency (MHz)	Format
		H (kHz)	V (kHz)		
WXGA	1280 × 768	47.8	59.9	79.5	HDMI/DVI-D/RGB
		60.3	74.9	102.3	
		68.6	84.8	117.5	
	1280 × 800	41.2	50.0	68.6	HDMI/DVI-D
		49.6	60.1	79.4	
		49.7	59.8	83.5	
		58.3	70.0	98.9	
		56.0	70.0	95.0	
		57.7	72.0	97.8	
		60.0	72.0	102.8	
		62.8	74.9	106.5	
		64.0	60.0	108.0	
	1360 × 768	47.7	60.0	86.7	HDMI/DVI-D/RGB
		56.2	72.0	100.2	
	1366 × 768	46.5	50.0	67.4	HDMI/DVI-D
1376 × 768	48.4	60.0	86.7	HDMI/DVI-D/RGB	
MAC21	1152 × 870	68.7	75.1	1000.0	RGB
SXGA	1152 × 900	64.2	70.4	94.6	HDMI/DVI-D/RGB
		61.2	65.2	92.0	
		61.9	66.0	94.5	
	1280 × 960	71.4	75.6	105.1	HDMI/DVI-D
		60.0	60.0	108.0	
	1280 × 1024	60.3	58.1	93.1	RGB
		62.5	58.6	108.0	
		63.3	60.0	108.2	
		63.4	60.0	111.5	
		63.7	60.0	109.5	
		63.8	60.2	108.2	
		63.9	60.0	107.4	
		64.0	60.0	108.0	
		71.7	67.2	117.0	
	1280 × 1024i	77.0	72.0	130.1	HDMI/DVI-D/RGB
80.0		75.0	135.0		
81.1		76.1	135.0		
MAC	1280 × 960	50.0	86.0	80.0	RGB
	1280 × 1024	50.0	94.0	80.0	
SXGA+	1400 × 1050	75.0	75.1	126.0	HDMI/DVI-D/RGB
		80.0	75.1	135.2	
		62.5	58.6	108.0	
	1440 × 900	64.0	60.0	108.2	HDMI/DVI-D/RGB
		64.0	60.2	108.0	
		64.7	59.9	101.0	
		65.1	59.9	122.4	
		65.3	60.0	121.8	
		65.4	60.1	122.9	
WXGA+	1440 × 900	55.9	59.9	106.5	RGB
UXGA	1600 × 1200	74.9	60.0	161.9	HDMI/DVI-D/RGB
		75.0	60.0	162.0	
UXGA*2	1600 × 1200	81.3	65.0	175.5	RGB
		87.5	70.0	189.0	
		93.8	75.0	202.5	
		106.3	85.0	229.5	
WSXGA+	1680 × 1050	65.3	60.0	146.3	HDMI/DVI-D/RGB
WUXGA	1920 × 1200	74.0	59.9	154.0	HDMI/DVI-D/RGB
WUXGA*2	1920 × 1200	74.6	59.9	193.3	RGB

*1 The "i" appearing after the resolution indicates an interlaced signal.
 *2 The "REAL" mode of "SCREEN" setting cannot be operated for these modes.



Serial connector

The serial connector complies with RS-232C. To control the projector from a personal computer, commands must be input through communication software, based on the format and satisfying the communication conditions shown below.

Pin assignments and signal names

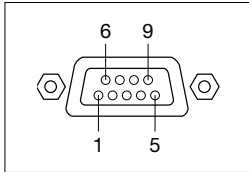

D-sub 9-pin (female) Serial input

No.	Signal name	Description	No.	Signal name	Description
1	-	NC	6	-	NC
2	TXD	Transmitted data	7	CTS	Connected internally
3	RXD	Received data	8	RTS	Connected internally
4	-	Connected internally	9	-	NC
5	GND	Ground			

Communication conditions (factory setting)

Signal level	RS-232C-compliant
Synchronization method	Start-stop synchronization
Baud rate	19,200 bps
Parity	None
Character length	8 bits
Stop bit	1 bit
X parameter	None
S parameter	None

Basic format

Transmission from the computer begins with STX, then the ID, command, parameter, and ETX are sent in this order. Add parameters according to the details of control.

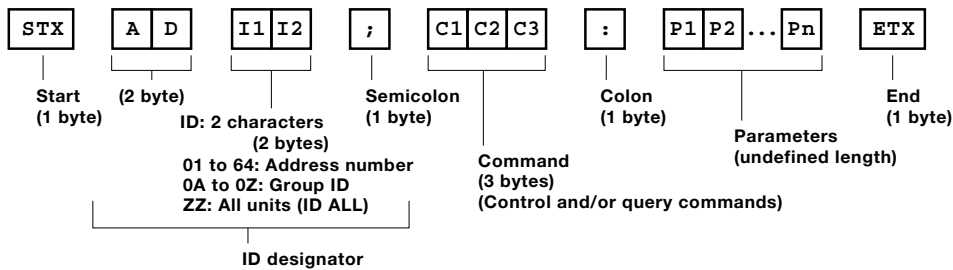

CAUTION

- It may not be possible to send or receive commands for about 10 to 60 seconds when the lamp is first turned on. If this occurs, wait for 60 seconds, then try sending or receiving again.
- When sending multiple commands, be sure to wait for at least 0.5 second after receiving a response from the projector before sending the next command.
- Additional time is sometimes required for response due to processing inside the projector. Set the time-out period for command response to 10 seconds or more.
- When using two or more units, set different IDs for each unit.

Cable specifications

Projector		PC (DTE)	
1	NC	NC	1
2			2
3			3
4	NC	NC	4
5			5
6	NC	NC	6
7	NC	NC	7
8	NC	NC	8
9	NC	NC	9

Control commands

Command : Parameter	Function		Callback
PON	Standby power	On	PON
POF		Off	POF
IIS:HD1	Input selection	Input 1 [HDMI]	IIS:HD1
IIS:DVI		Input 1 [DVI-D]	IIS:DVI
IIS:RG1		Input 1 [RGB (PC)]	IIS:RG1
IIS:RG2		Input 2 [RGB (PC)]	IIS:RG2
IIS:CP1		Input 2 [RGB (YPbPr/YCbCr)]	IIS:CP1
IIS:VD1		Input 2 [Video]	IIS:VD1
IIS:CP2		Input 3 [component]	IIS:CP2
IIS:SVD		Input 3 [S-Video]	IIS:SVD
IIS:VD2		Input 3 [Video]	IIS:VD2
OLP: 2	Lamp power	Auto	OLP: 2
OLP: 0		Normal	OLP: 0
OLP: 3		Eco 1	OLP: 3
OLP: 4		Eco 2	OLP: 4
OSH: 0	AV mute	Off	OSH: 0
OSH: 1		On	OSH: 1
OFZ: 1	Freeze	On	OFZ: 1
OFZ: 0		Off	OFZ: 0
OAS	Auto setup		OAS
VSE: 0	Screen (aspect)	Normal	VSE: 0
VSE: 6		Full	VSE: 6
VSE: 2		Wide (16:9)	VSE: 2
VSE: 40		Zoom	VSE: 40
VSE: 5		Real	VSE: 5
VSE: 50		Custom	VSE: 50
VPM: STD	Picture	Standard	VPM: STD
VPM: DYN		Dynamic	VPM: DYN
VPM: CIN		Cinema	VPM: CIN
VPM: REA		Real	VPM: REA

* Do not send PON, POF or OSH commands continuously in a short period of time. Doing so may burst the lamp or shorten the lamp replacement cycle.

* When a command that cannot be executed during standby mode is sent, the projector will send an ER401 command in reply.

Status request commands

Command:Parameter	Function	Callback	Description
QPW	Main power status	000	Off
		001	On
QIN	Input signal status	HD1	Input 1 [HDMI]
		DVI	Input 1 [DVI-D]
		RG1	Input 1 [RGB (PC)]
		RG2	Input 2 [RGB (PC)]
		CP1	Input 2 [RGB (YPbPr/YCbCr)]
		VD1	Input 2 [Video]
		CP2	Input 3 [component]
		SVD	Input 3 [S-Video]
		VD2	Input 3 [Video]
QLP	Lamp power mode status	2	Auto
		0	Normal
		3	Eco 1
		4	Eco 2
QSH	AV mute function status	0	Off
		1	On
QFZ	Freeze function status	0	On
		1	Off
QSE	Aspect mode status	0	Normal
		6	Full
		2	Wide (16:9)
		40	Zoom
		5	Real
		50	Custom
		0	Normal
QPM	Picture mode status	STD	Standard
		DYN	Dynamic
		CIN	Cinema
		REA	Real
QST	Projector run time	p1p2p3p4p5	00000 – 99999 hours
Q\$L:1	Lamp run time	p1p2p3p4	0000 – 9999 hours
QTM:0	Temperature status	p1p2p3p4 / p5p6p7p8 *1	Air intake
QTM:2		p1p2p3p4 / p5p6p7p8 *1	Panel section

*1 p1p2p3p4 = Celsius (°C), p5p6p7p8 = Fahrenheit (°F)

NOTE: If a wrong command is received, the projector will send an ER401 or ER402 command to the computer.

Command example

To set the AV mute function on, send the command as shown below.

```

STX   ADZZ ; OSH : 1   ETX
  |       |       |       |       |
  Start  ID Address Command Parameter End
Character code 02 ZZ: ID ALL                               Character code 03
    
```

NOTE: When sending commands without parameters, a colon (:) is not necessary.

Notes on projector placement and operation

The projector uses a high-wattage lamp that becomes very hot during operation. Please observe the following precautions.

1. Never place objects on top of the projector.
2. Make sure there is an unobstructed space of 1,000 mm (3 feet 3 inches) or more around the projector's exhaust openings.
3. Do not stack projector units directly on top of one another for the purpose of multiple (stacked) projection. When stacking projector units, be sure to provide the amount of space indicated below between them. These space requirements also apply to installations where only one projector unit is operating at one time and the other unit is used as a backup.
4. Make sure that nothing blocks the projector's air intake and exhaust openings. Also, install the projector so that cool or hot air from other air conditioning equipment does not flow directly toward the projector's air intake or exhaust openings.
5. Do not install the projector in an enclosed space. If it is necessary to install it in an enclosed space, add a separate ventilation system. If ventilation is insufficient, hot air will accumulate at the intake opening. This may cause the projector's protective circuit to interrupt projector operation.
6. If the projector is installed in an enclosed space, ensure that the projector's intake and exhaust openings are not blocked. Take particular care to ensure that hot air from the exhaust openings is not sucked into the intake openings.
7. When installing the projector in any manner other than floor mounting with the adjuster legs, use the five threaded ceiling mount holes (screw diameter: M6, projector interior thread length: 12 mm) to secure the projector.

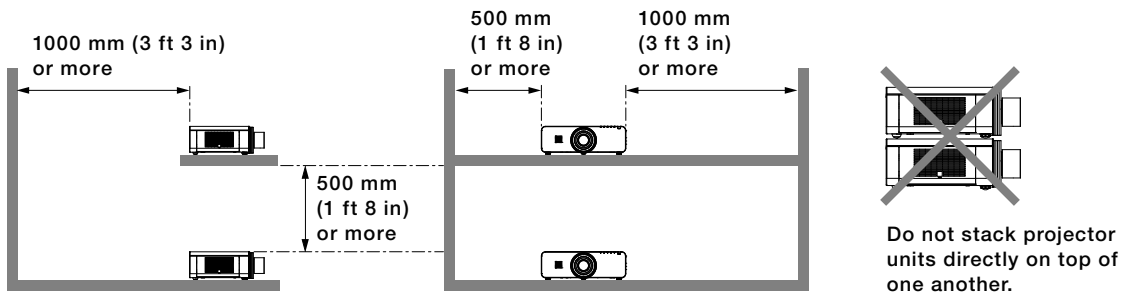

Direction of air intake and exhaust

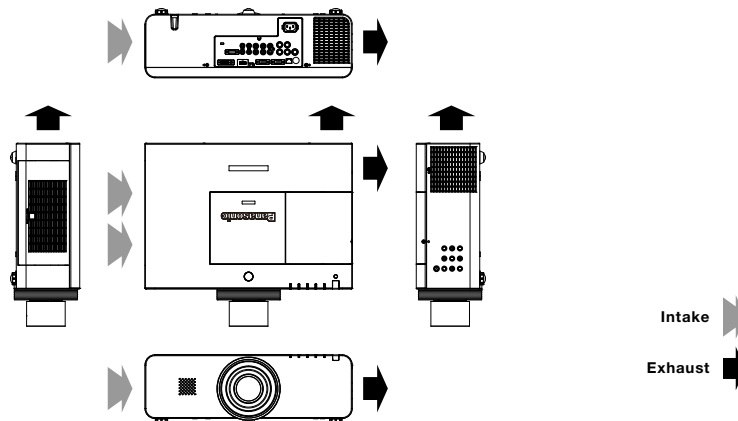

Operating the projector continuously

1. If the projector is to be operated continuously 12 hours or more, lamp replacement cycle duration becomes shorter.
2. The lamp replacement cycle duration becomes shorter if the projector is operated repeatedly for short periods.



Weights and dimensions shown are approximate. Specifications and appearance are subject to change without notice.
Product availability differs depending on region and country. This product may be subject to export control regulations.

PJLink is a registered trademark, or a trademark application has been filed, in Japan, the United States, and other countries and regions.
All other trademarks are the property of their respective trademark owners.